

REF36RCPIXR

36" BUILT-IN REFRIGERATOR COLUMN
STAINLESS STEEL RIGHT SWING DOOR



Preserve the nutrients, texture and taste of all fresh and packaged foods with state-of-the-art sensor managed temperature zones combined with a variable speed compressor.

Enjoy ample and flexible food storage thanks to Bertazzoni's columns design featuring the most usable interior depth in the category.

Ensure optimize food preservation with metal and glass material refrigeration bins, crispers, shelves for scent & aroma neutral storage

Access all temperature and humidity settings through the intuitive digital touch-control interface.

Maintain the correct temperature in the refrigerator when opening the door for reloading, thanks to the unique lateral side-to-side airflow circulation.

Create a truly flush front alignment with the adjacent cabinets and minimal clearance with the exclusive "lift & swing" door hinge.

Customize virtually any column combination suited for your kitchen layout. Single, double, triple and more configurations are possible.

Create a harmonized look throughout the kitchen selecting the handle style that matches your complete Bertazzoni appliances suite. Panel ready models provide the option to mount your own cabinet hardware.

Designed and manufactured with pride in Italy.

Have peace of mind with a standard full 2 years parts & labor warranty and 5 years warranty for the entire sealed system.

PRODUCT FEATURES

Size	H: 84" W: 36" D: 24 3/8"
Refrigerator type	Built-in refrigerator column
Door finish	Stainless steel
Interior finish	White aluminum
User interface	Digital touch control interface inside
Lighting	LED lights interior illumination
Shelves	4
Crispers	3
Door storage	3
Cooling system	Lateral airflow
Modes	Shopping, Vacation, Sabbath mode
Open door alarm	Yes

INTERIOR CAPACITY

Total volume	21.54 cu.ft
--------------	-------------

TECHNICAL SPECIFICATIONS

Electrical supply	115 V 60 HZ - 218 W 2 Amp
Power connection	NEMA 5-15P with 79" power cord
DOE Compliant	Yes
Energy consumption	355.0 kWh/yr
Certification	cUL
Warranty	2 years parts & labor Sealed system: 5 years labor
Packaging dimensions and weight	W 37 6/16" H 89" D 31 2/16" 436.52 lbs

OPTIONAL ACCESSORIES

901560	42" Bridge toekick
901561	48" Bridge toekick
HERHKCOL	Handle kit for columns Heritage
MASHKCOL	Handle kit for columns Master
PROHKCOL	Handle kit for columns Professional

REF36RCPIXR

36" BUILT-IN REFRIGERATOR COLUMN
STAINLESS STEEL RIGHT SWING DOOR



PRODUCT DIMENSIONS

SIDE VIEW

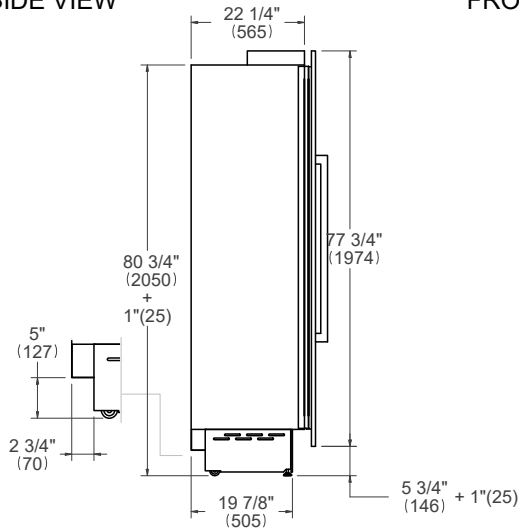

FRONT VIEW

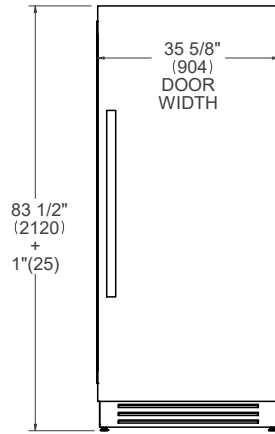

TOP VIEW

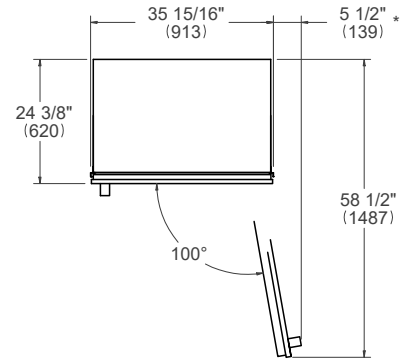

* Maximum Overall Handle Dimension

ELECTRICAL CONNECTION

TOP VIEW

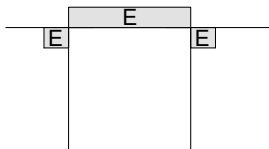

FRONT VIEW

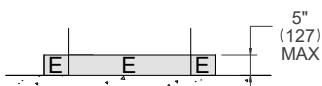

E A properly-grounded, horizontally-mounted electrical receptacle should be installed according to this drawing.

Connection(s) placement within the opening may require additional cabinet depth.

INSTALLATION REQUIREMENTS

If the appliance(s) is not connected through the side profile trims to secured cabinetry anti-tip brackets must be installed.

CUTOUT DIMENSIONS

TOP VIEW

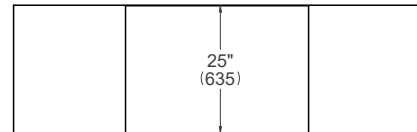

SIDE VIEW

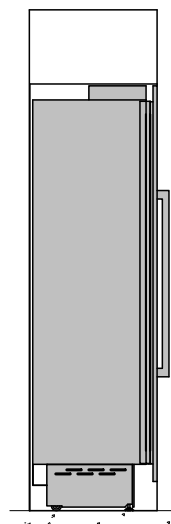

FRONT VIEW

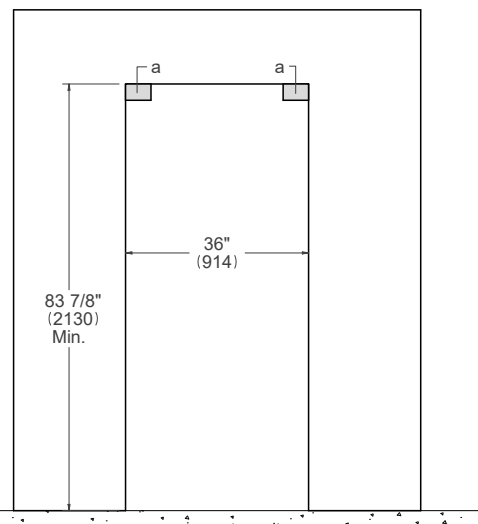

(a) Area to be left clear for the anti-tipping brackets – 3"1/2x5" (82x127mm)

For installation of multiple products in combination, refer to the Built-in Food Preservation Design Guide at us.bertazzoni.com or ca.bertazzoni.com

Disclaimer: while every effort has been made to ensure the accuracy of the information contained in this document, Fratelli Bertazzoni reserves the right to change it at any time without notice. For detailed installation instructions, consult the installation manual. Fratelli Bertazzoni, Bertazzoni and the winged wheel brand icon are registered trademarks of Bertazzoni Spa.