

USER GUIDE – LED LIGHTED MIRROR

IMPORTANT

PLEASE READ THE INSTRUCTIONS BEFORE SET UP AND INSTALLATION

Component parts and fittings

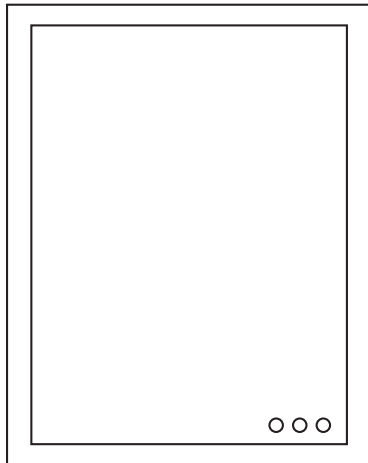

LED Mirror

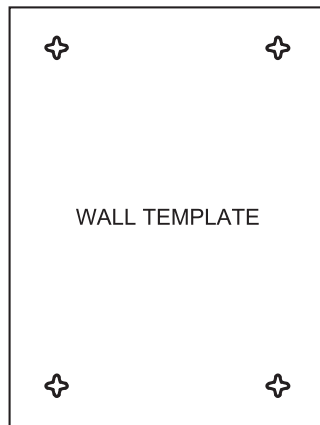

Paper Template x1



Gloves x 1



Wire nut x 3
(Included in pack)



Screw & Wall Anchor x 4
(Included in pack)

Suggested Tools:



Screw driver



Drill

Safety Warning

Safety:

- We suggest you spend a short time reading the instruction leaflet.
- Carefully check that you have all the parts before beginning assembly.
- Keep small parts and fittings out of children's reach and keep children well away from construction area, as the unassembled product contains small parts, which could present a choking hazard.
- We suggest you retain these instructions for future reference.
- This appliance can be used by adults ONLY.
- If the supply cord is damaged, it must be replaced by the manufacturer, its service agent or similarly qualified persons in order to avoid a hazard.

Caution:

- In order to avoid overheating, do not cover the mirror.
- Switch off the mains supply and remove the appropriate fuse or switch off the appropriate circuit breaker before commencing installation
- Make sure that there is no danger that the cord or extension cord is inadvertently be pulled or cause anyone to trip when in use.

Assembly/User Instruction

Please read all instructions carefully. Before you proceed to install, make sure that the power supply is turned off and remains off until installation is complete.

***This mirror can be mounted horizontally or vertically.**

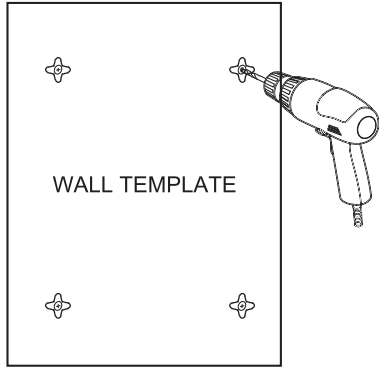

STEP1. Place the wall template on the wall in the location selected for the mirror. Make sure the wall template is level and in the correct position. Secure the wall template to the wall then mark the location of the 4 wall anchors as indicated on the template from the wall. Remove the wall template from the wall.

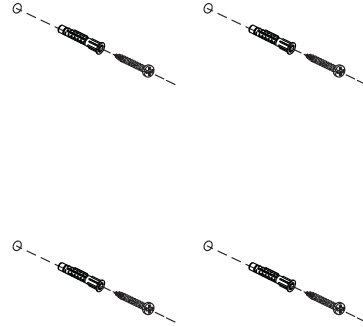

STEP2. Create holes on wall marks and screw the wall anchors, Secure screws into wall anchors.

STEP3. Connect to the main supply by plug, or cut the plug then connect to junction box main supply.

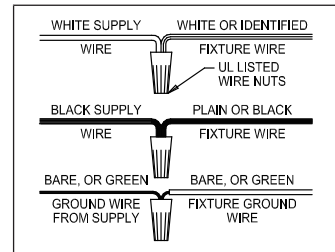
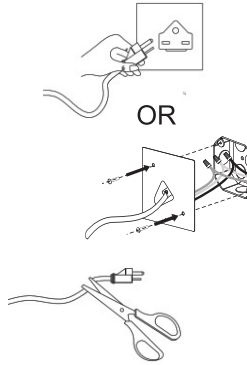
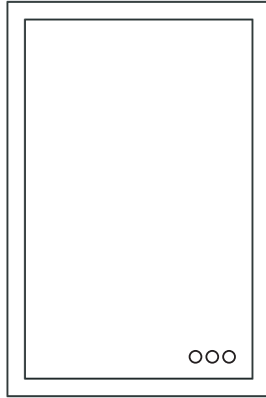
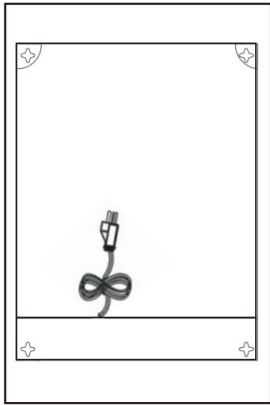

STEP4. Hang up the Mirror on the wall

