



MIRROR / MIROIR / ESPEJO

Thank you for purchasing this quality product. Be sure to check all packing material carefully for small hardware which may have come loose inside the carton during shipment. Identify and count all hardware and compare with the hardware list below.



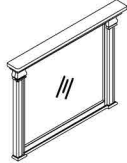

Merci d'avoir acheté ce produit de qualité. Vérifier de bien avoir toutes les petites pièces de quincaillerie en votre possession; certaines ont pu se retrouver dans le fond de la boîte durant le transport. Identifier et compter les pièces de quincaillerie, puis les comparer avec la liste ci-dessous.

Gracias por su compra de este producto de calidad. Revise con cuidado el cajón donde se encuentra el paquete de materiales. Algunos materiales pequeños podrían haber salido del paquete durante el transporte. Identifique y cuente el material y compárelo con la lista proporcionada abajo.

PARTS LIST LISTE DES PIÈCES LISTA DE PIEZAS

No. N° No.	Description La Description Descripción	Sketch Illustration Esquema	Quantity Quantité Cantidad
1	Mirror Miroir Espejo		1
2	Mirror support Supporte de miroir Soporte del espejo		2
3	Dresser Commode Tocador		1

HARDWARE LIST LISTE DES PIÈCES DE QUINCAILLERIE LISTA DE MATERIALES

No. N° No.	Description La Description Descripción	Sketch Illustration Esquema	Size Taille Tamaño	Quantity Quantité Cantidad
A	Allen bolt Vis à tête creuse hexagonale Perno allen		Ø1/4" x 1-3/16"	8
B	Lock washer Rondelle de blocage Arandela de seguridad		Ø1/4"	8
C	Flat washer Rondelle plate Arandela plana		Ø1/4" x 3/4"	8
D	Allen key Clé hexagonale Llave allen		M4	1

MIRROR / MIROIR / ESPEJO

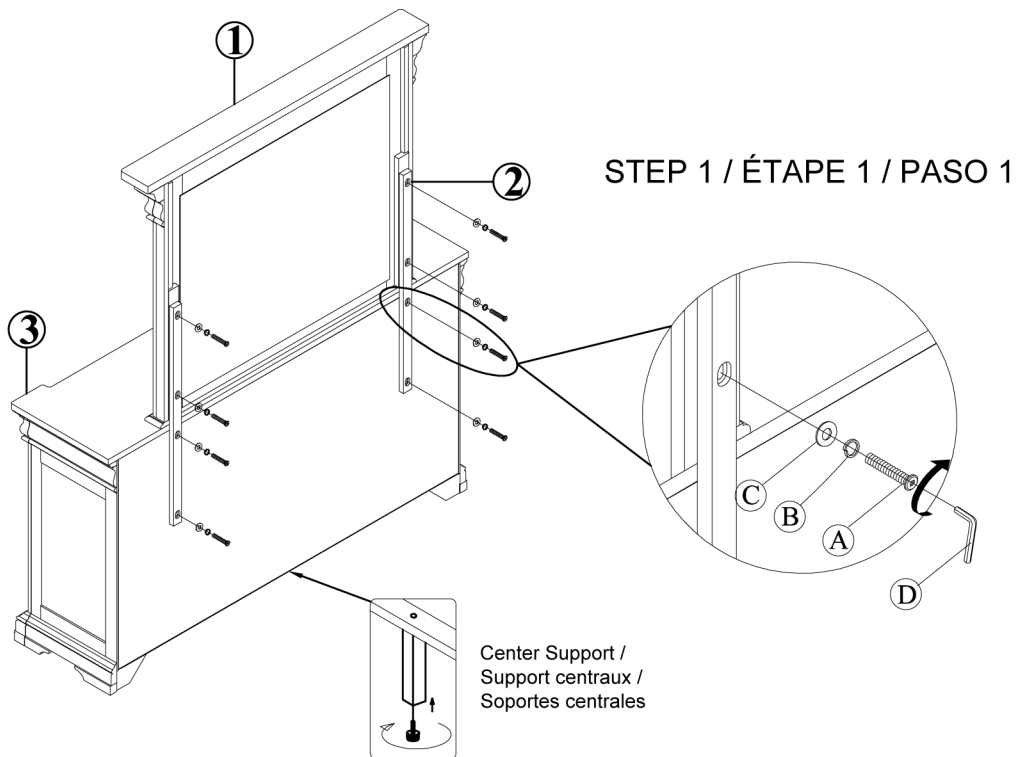

STEP 2 / ÉTAPE 2 / PASO 2

