

DESCRIPTION/ LA DESCRIPTION/ DESCRIPCIÓN: UPH Arm Chair 2/ctn / Chaise à accoudoirs 2 pièce / Silla con brazos 2 unid.

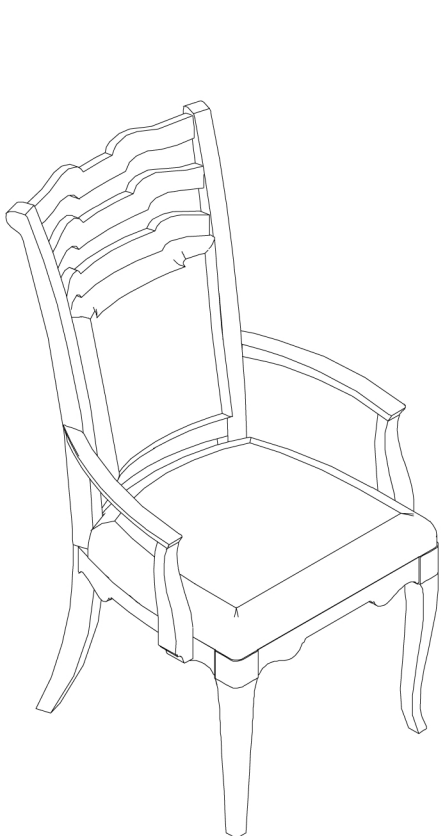

**A**

x1 Chair Back \*  
x1 Dossier de chaise  
x1 Respaldo de la silla

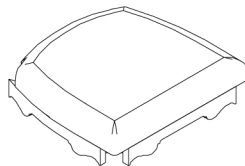

**B**

x1 Seat Cushion \*  
x1 Coussin de siège  
x1 cojín del asiento



**C**

x2 Front Leg \*  
x2 Patte avant  
x2 Pata delantera

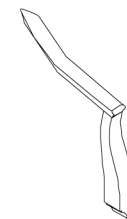

**D**

x1 Left Armrest \*  
x1 Accoudoir de gauche  
x1 Brazo izquierda

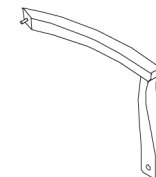

**E**

x1 Right Armrest \*  
x1 Accoudoir de droite  
x1 Brazo derecha



**F**

x2 Allen bolt Ø5/16"\*2" \*  
x2 Vis à tête creuse hexagonale Ø5/16"\*2"  
x2 Perno Allen Ø5/16"\*2"



**G**

x4 Allen bolt Ø5/16"\*3" \*  
x4 Vis à tête creuse hexagonale Ø5/16"\*3"  
x4 Perno Allen Ø5/16"\*3"



**H**

x2 Allen bolt Ø5/16"\*1-1/2" \*  
x2 Vis à tête creuse hexagonale Ø5/16"\*1-1/2"  
x2 Perno Allen Ø5/16"\*1-1/2"



**I**

x12 Lock washer Ø5/16" \*Ø12\*3mm \*  
x12 Rondelle de blocage Ø5/16" \*Ø12\*3mm  
x12 Arandela de Seguridad Ø5/16" \*Ø12\*3mm



**J**

x12 Flat Washer Ø5/16"x19x2mm \*  
x12 Rondelle plate Ø5/16"x19x2mm  
x12 Arandela plana Ø5/16"x19x2mm



**K**

x4 Ø5/16"\*12 Nut \*  
x4 Ø5/16"\*12 Écrou  
x4 Ø5/16"\*12 Tuerca

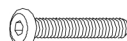

**L**

x2 Allen bolt Ø1/4"\*1-3/4" \*  
x2 Vis à tête creuse hexagonale Ø1/4"\*1-3/4"  
x2 Perno Allen Ø1/4"\*1-3/4"



**M**

x2 Flat Washer Ø1/4"x13x2mm \*  
x2 Rondelle plate Ø1/4"x13x2mm  
x2 Arandela plana Ø1/4"x13x2mm



**N**

x1 12mm Open Wrench \*  
x1 12mm Clé à fourche  
x1 12mm Llave de boca



**O**

x1 Allen Key 4mm \*  
x1 Clé hexagonale 4mm  
x1 Llave Allen 4mm

\*Replaceable Part

DESCRIPTION/ LA DESCRIPTION/ DESCRIPCIÓN: UPH Arm Chair 2/ctn / Chaise à accoudoirs 2 pièce / Silla con brazos 2 unid.

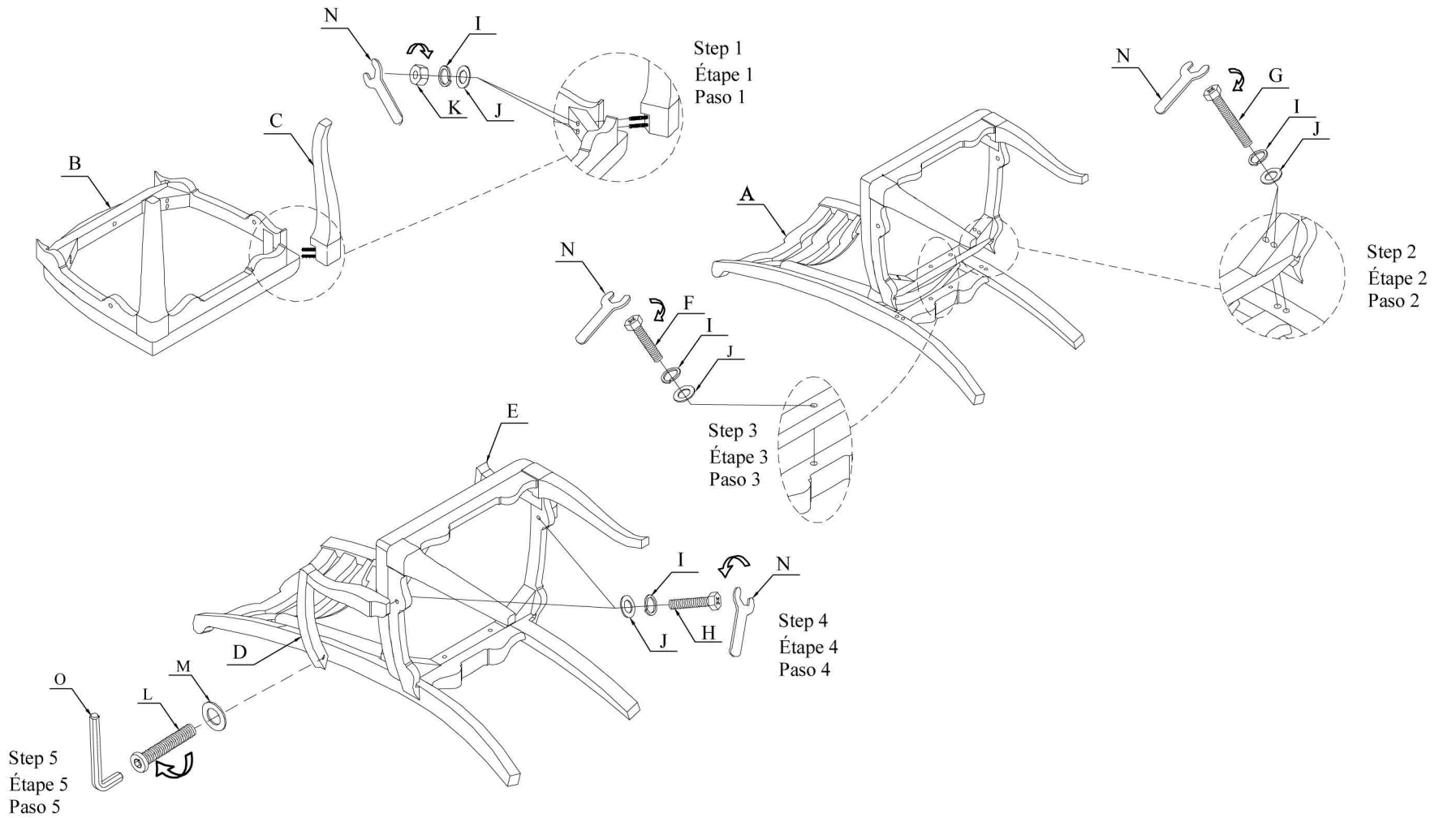

\*Replaceable Part

DESCRIPTION/ LA DESCRIPTION/ DESCRIPCIÓN: UPH Arm Chair 2/ctn / Chaise à accoudoirs 2 pièce / Silla con brazos 2 unid.

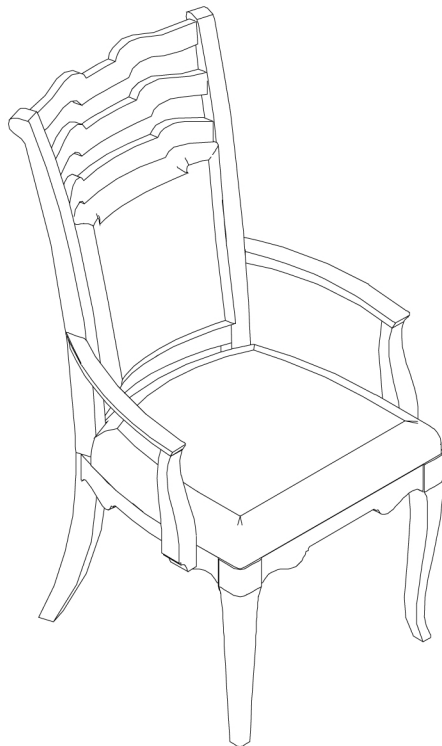

RP293271 BACK \*  
x1 Chair Back with Cushion  
x1 Dossier de chaise  
x1 Respaldo de silla

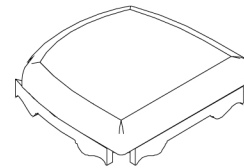

RP293271-FRAME \*  
x1 Seat frame with Cushion  
x1 Côté du cadre  
x1 Armazón latera



RP293271 LEG \*  
x2 Front Leg  
x2 Patte avant  
x2 Pata delantera

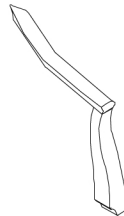

RP293271 AIML \*  
x1 Left Armrest  
x1 Accoudoir de gauche  
x1 Brazo izquierda

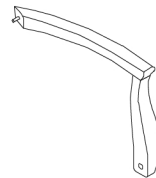

RP293271 AIMR \*  
x1 Right Armrest  
x1 Accoudoir de droite  
x1 Brazo derecha

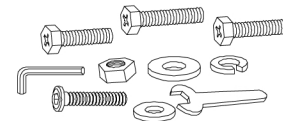

RP293271-HWKIT \*  
x1 Hardware Kit  
x1 Liste des pièces de quincaillerie  
x1 Lista de materiales



RC-WH-NAIL \*  
x4 Plastic Nail  
x4 Clou  
x4 Clavo

\*Replaceable Part