

x4 Bun Foot *
x4 Pied en forme d'oignon
x4 Pata redonda

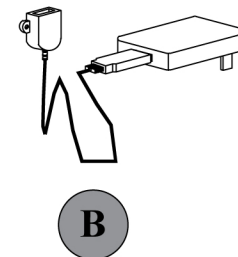

x1 USB port *
x1 Prises USB
x1 Conectores USB

**Replaceable Part*

DESCRIPTION / DESCRIPCIÓN : NIGHTSTAND W/ USB PORT / TABLE DE CHEVET / MESA DE NOCHE

STEP 1

Fasten The Leg As Shown.

ÉTAPE 1

Attachez la jambe Comme Indiqué.

PASO 1

Sujete la Pierna Como Se Muestra .

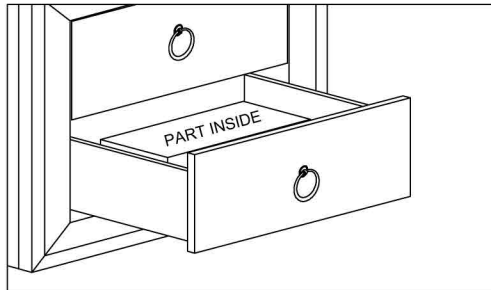

BUN FOOTS (PACKED INSIDE DRAWER)
PIED EN FORME D'OIGNON (EMBALLÉS À L'INTÉRIEUR DU TIROIR)
PATA REDONDA (EMPAQUETADO DENTRO DEL CAJÓN

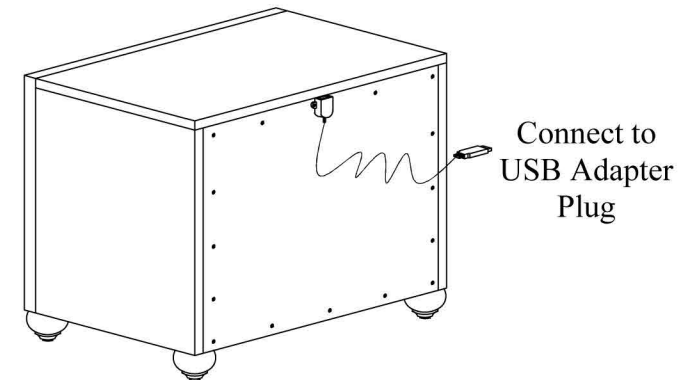
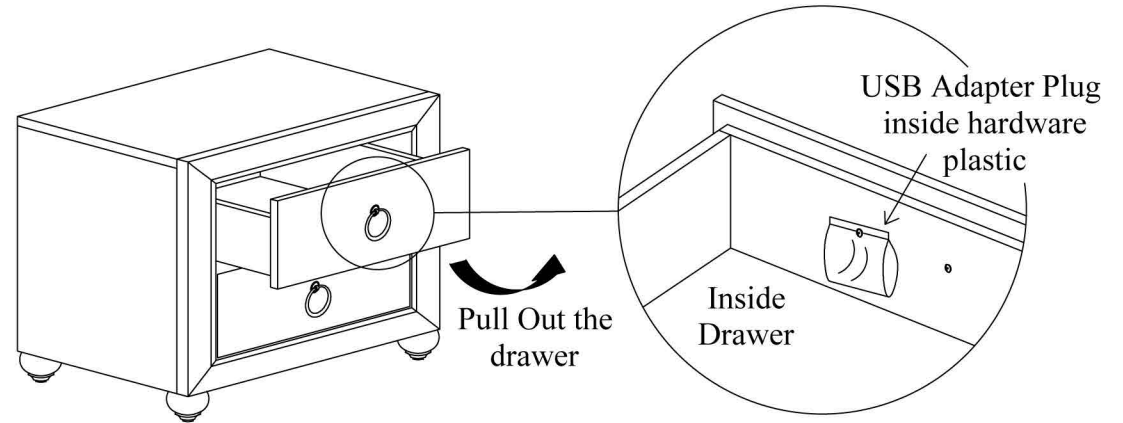
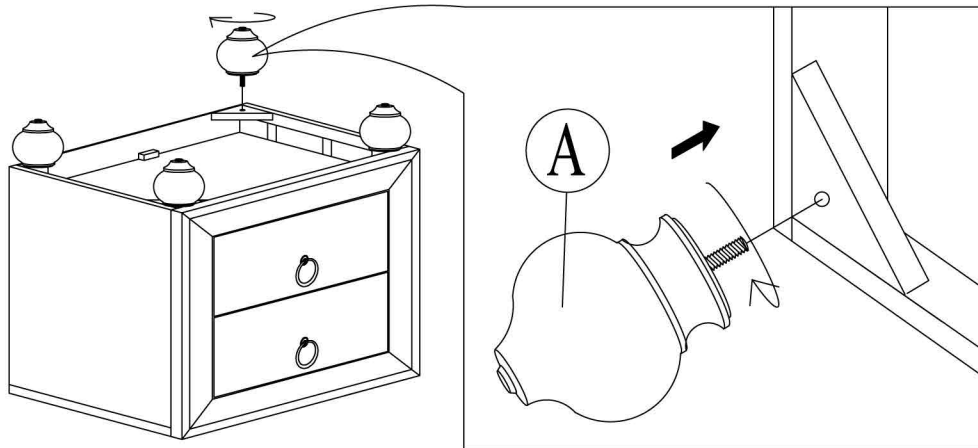

**Replaceable Part*

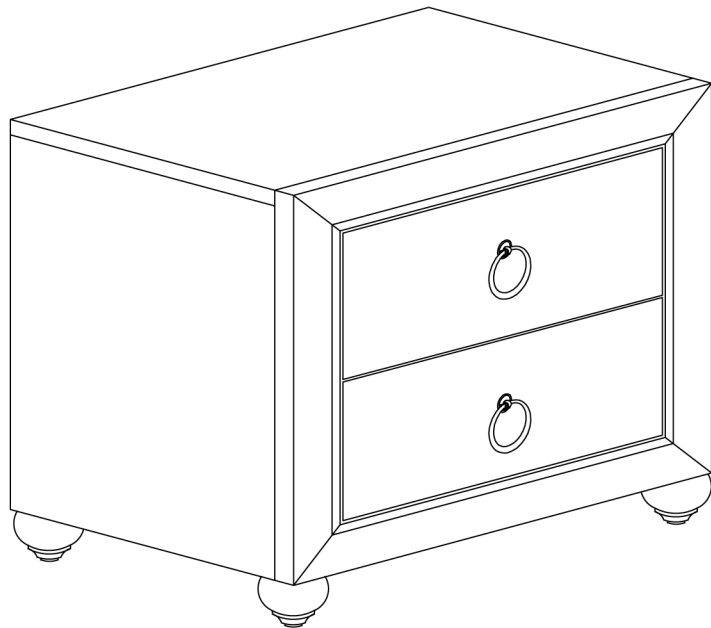
**DESCRIPTION / DESCRIPCIÓN : NIGHTSTAND W/ USB PORT / TABLE DE CHEVET /
MESA DE NOCHE**

x2 RS458-410- PULL *
Pull with Screw
Tirer + vis
Tire + Tornillo

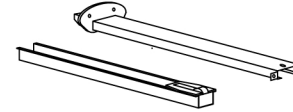

x2 RS458-410-DG *
Drawer Glide
Glissière
Carril de deslizamiento

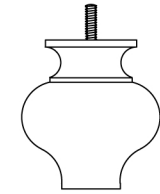

x4 RS458-410-FOOT *
Bun Foot
Pied en forme d'ognon
Pata redonda

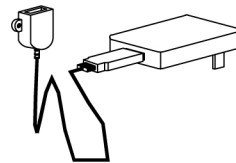

x1 RS458-450-USB *
USB port
Prises USB
Conectores USB



x4 RC-BR-NAIL *
Brown Plastic Nail
Clou en plastique
Clavo de plástico

**Replaceable Part*

Protect Your Wood or Laminate Flooring

*This statement applies to any floor without carpet.

If not careful, all furniture including upholstery and case pieces can scratch, scuff and even gouge floors. The recommendation is to have felt, rubber pads or area rugs under furniture on flooring without carpet.

Moving your furniture

Pushing and dragging furniture over floors without carpet can lead to scratches and scuffs. Have someone help when moving the larger pieces of furniture by lifting, try using a dolly or moving pads.

Felt and rubber pads

Applying furniture pads to the feet of furniture helps cushion contact points. Furniture pads can be found at local hardware stores. Felt pads slide easily across the floor, making them ideal for dining chairs and other pieces that move with use. Rubber pads will help furniture stay in place and are perfect for larger pieces, like sofas and loveseats.

Area rugs and rug pads

Using an area rug under furniture is another way to protect your floor from scratches and scuff marks. A rug pad under the area rug will provide extra cushion and added protection.