

DESCRIPTION/ LA DESCRIPTION/ DESCRIPCIÓN: Bedside Table- Main Finish / Table de nuit / Mesa de noche

WARNING

Children have died from furniture tipover. To reduce the risk of furniture tipover :

- ALWAYS install tipover restraint provided.
- NEVER put a TV on this product.
- NEVER allow children to stand, climb or hang on drawers, doors, or shelves.
- NEVER open more than one drawer at a time.
- Place heaviest items in the lowest drawers.

This is a permanent label. Do not remove!

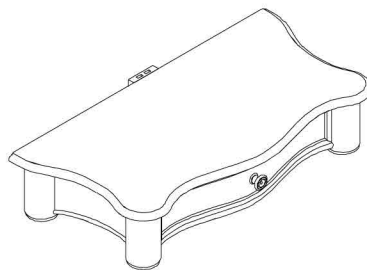

A

x1 Table Top
x1 Dessus de table
x1 Tablero de mesa

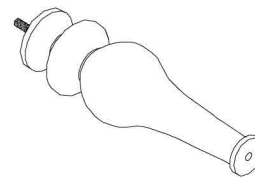

B

x4 Leg *
x4 jambe
x4 Pierna

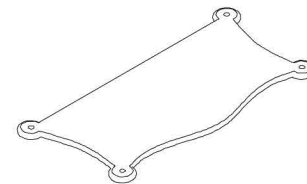

C

x1 Shelf *
x1 étagère
x1 repisa

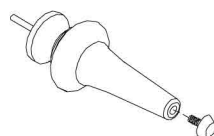
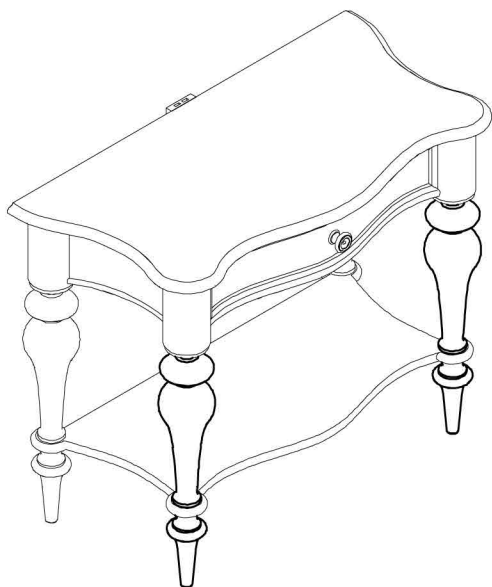

D

x2 Foot (Front) *
x2 Pied (Avant)
x2 Pie (Delantera)

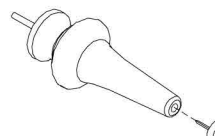

E

x2 Foot (Back) *
x2 Pied (Arrière)
x2 Pie (Trasera)

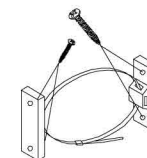

F

x1 Tipping restraint *
x1 Liste des pièces de quincaillerie antibasculment
x1 Abrazadera antivuelco

*Replaceable Part

DESCRIPTION/ LA DESCRIPTION/ DESCRIPCIÓN: Bedside Table- Main Finish / Table de nuit / Mesa de noche

WARNING

Children have died from furniture tipover. To reduce the risk of furniture tipover :

- ALWAYS install tipover restraint provided.
- NEVER put a TV on this product.
- NEVER allow children to stand, climb or hang on drawers, doors, or shelves.
- NEVER open more than one drawer at a time.
- Place heaviest items in the lowest drawers.

This is a permanent label. Do not remove!

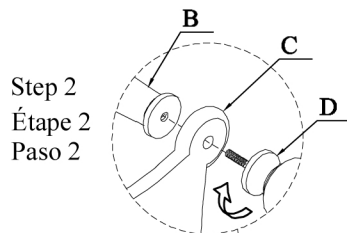

Tipping restraint/
Liste des pièces de quincaillerie antibasculement/
Abrazadera antivuelco

Step 1
Étape 1
Paso 1

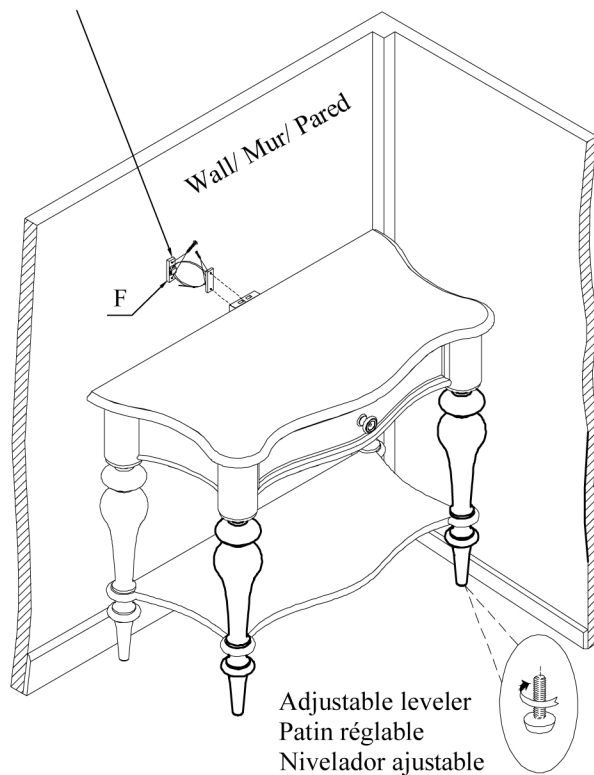
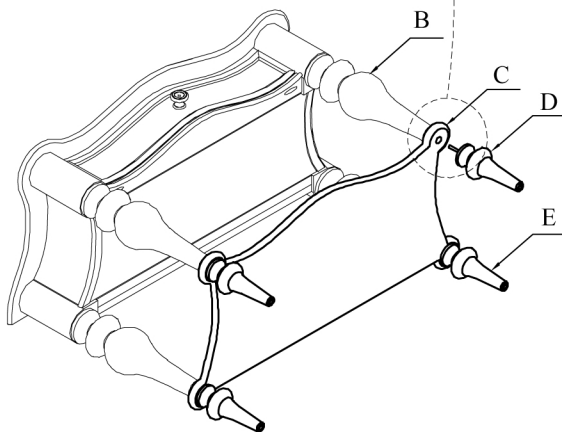
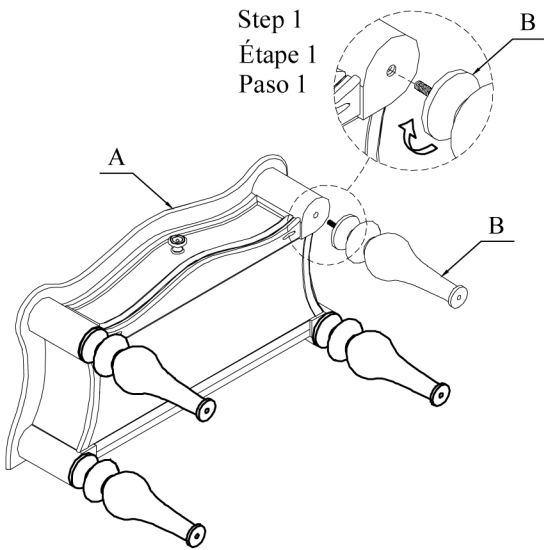

*Replaceable Part

WARNING	
	<p>Children have died from furniture tipover. To reduce the risk of furniture tipover :</p> <ul style="list-style-type: none"> • ALWAYS install tipover restraint provided. • NEVER put a TV on this product. • NEVER allow children to stand, climb or hang on drawers, doors, or shelves. • NEVER open more than one drawer at a time. • Place heaviest items in the lowest drawers.
	<p><i>This is a permanent label. Do not remove!</i></p>

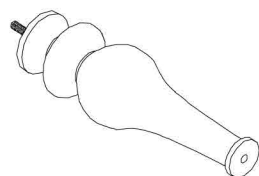

RP293141 LEG *
x4 Leg
x4 Jambè
x4 Pierna

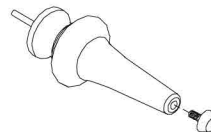

RP293141 FOOTF *
x2 Foot (Front)
x2 Pied (Avant)
x2 Pie (Delantera)

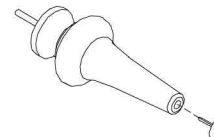

RP293141 FOOTB *
x2 Foot (Back)
x2 Pied (Arrière)
x2 Pie (Trasera)

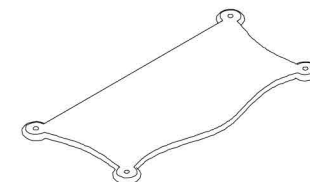

RP293141-SHELF *
x1 Shelf
x1 étagère
x1 repisa

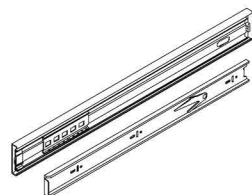

COMGLIDE-10-45 *
x1 Common Drawer Glide
x1 Glissière
x1 Carril de deslizamiento



RP293-KNOBL *
x1 Large Knob with Screw
x1 Gros POIGNÉE et vis
x1 TIRADOR grande y Tornillo



RC-FG-WHITE *
x2 Common Adjustable Leveler
x2 Patin réglable
x2 Nivelador ajustable



RC-WH-NAIL *
x2 Plastic Nail
x2 Clou
x2 Clavo

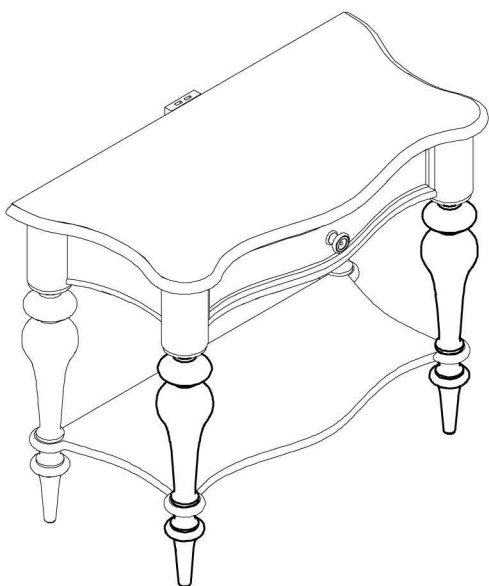

RP293141-FELT *
x1 Removable Felt
x1 Feutre
x1 Fieltro

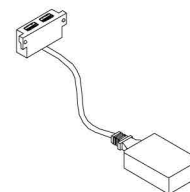

RP293141-USB *
x1 USB Port
x1 Prise USB
x1 Conector USB



RC-ANTI-TIP *
x1 Anti-tipping Restraint
x1 Liste des pièces de quincaillerie antibasculément
x1 Lista del kit de materiales antivuelco

*Replaceable Part