

**A**

x8 Hex Comb Bolt ( 5/16 x 2" ) \*  
 x8 Peigne Hexagonal (5/16 x 2")  
 x8 Perno Hexagonal (5/16 x 2")



**B**

x8 Spring Washer M8 \*  
 x8 Rondelle à ressort M8  
 x8 Arandela auto-bloquante M8



**C**

x8 Flat Washer M8 \*  
 x8 Rondelle Plate M8  
 x8 Arandela Plana M8

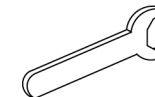

**D**

x1 Wrench (13MM) \*  
 x1 Clé (13MM)  
 x1 llave inglesa (13MM)

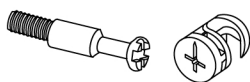
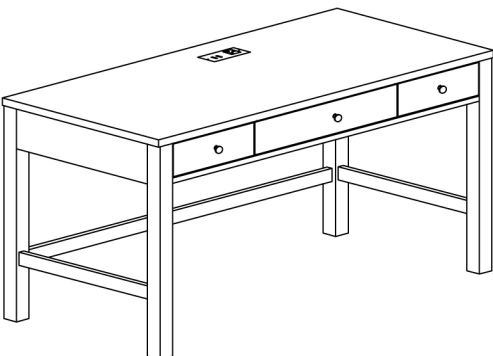

**E**

x2 Locking Pin \*  
 x2 Broche de verrouillage  
 x2 Pin de seguridad

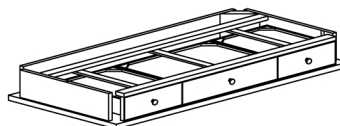

**F**

x1 Writing Desk Top Panel  
 x1 Panneau supérieur de bureau  
 x1 Panel de escritorio



**G**

x1 Bottom Stretcher  
 x1 Civière inférieure  
 x1 Camilla inferior

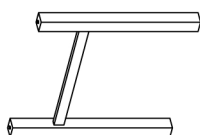

**H**

x1 Leg Frame (Left) \*  
 x1 Cadre De Jambe (Gauche)  
 x1 Marco De La Pierna (Izquierda)

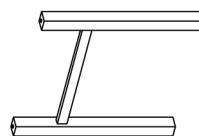

**I**

x1 Leg Frame (Right) \*  
 x1 Cadre De Jambe (Droite)  
 x1 Marco De La Pierna (Derecha)

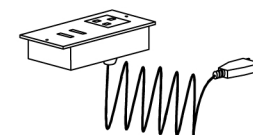

**J**

x1 Power Adapter w/USB \*  
 x1 Adaptateur secteur avec usb  
 x1 Adaptador de corriente w/USB

*\*Replaceable Part*

#### STEP 1

Fixed the Bottom Panel Support.

#### ÉTAPE 1

Fixé Le Support Du Panneau inférieur.

#### PASO 1

Fijo El Soporte Del Panel inferior.

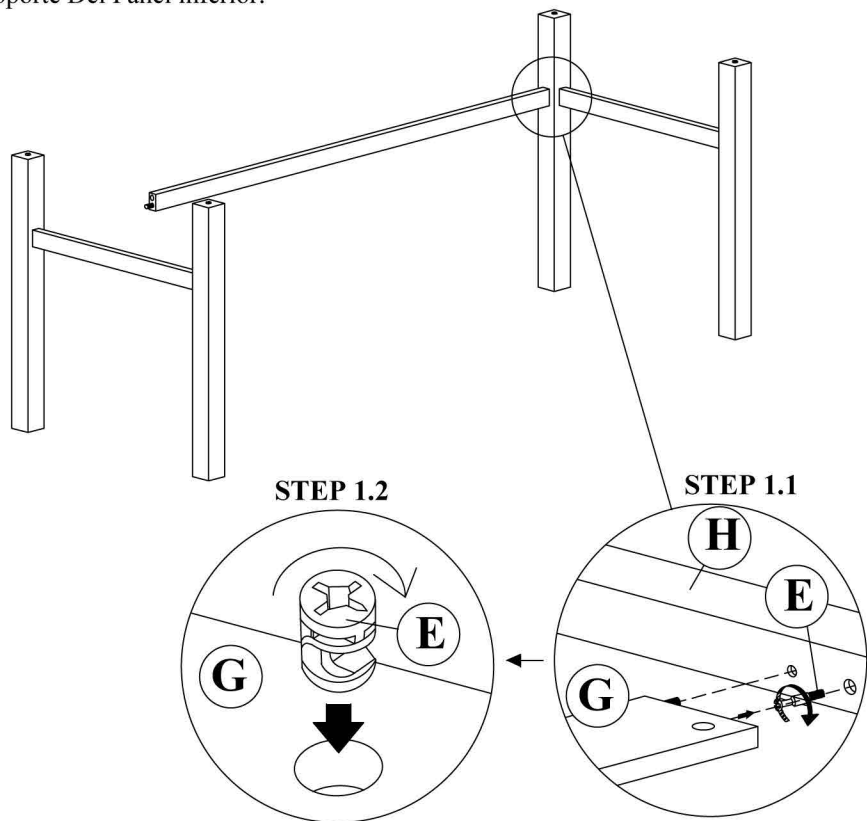

#### STEP 2

Fixed the Leg Frame.

#### ÉTAPE 2

Fixé le Cadre de la jambe.

#### PASO 2

Arreglado El Marco De La Pierna.

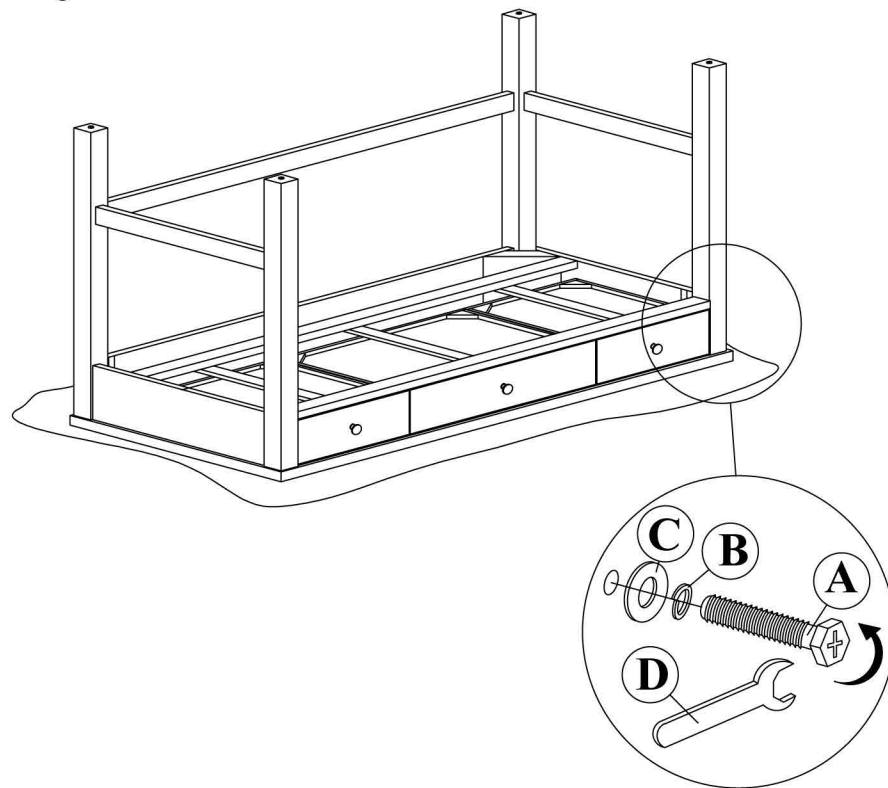

*\*Replaceable Part*



x3 RS496-414-KNOB \*  
Knob with Screw  
Poignée + vis  
Tirador + Tornillo

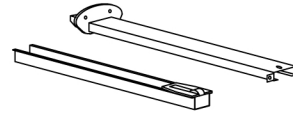

x3 RS496-414-DG \*  
Drawer Glide  
Glissière  
Carril de deslizamiento

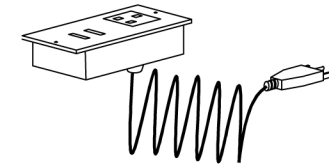

x1 RS496-414-USB \*  
Power Adapter w/USB  
Adaptateur secteur avec usb  
Adaptador de corriente w/USB

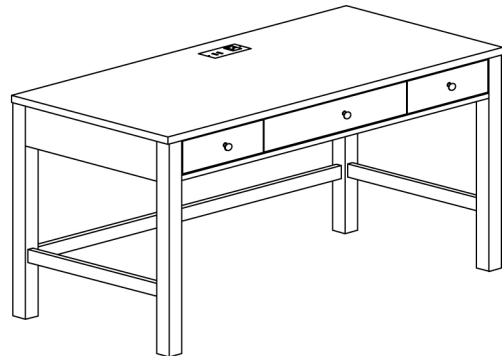

x4 RC-BR-NAIL \*  
Brown Plastic Nail  
Clou en plastique  
Clavo de plástico

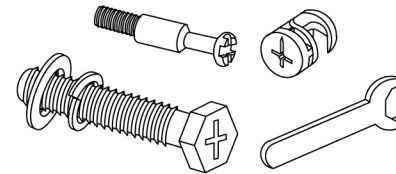

x1 RS496-414-HWKIT \*  
Hardware Kit  
Liste des pièces de quincaillerie  
Lista del kit de materiales

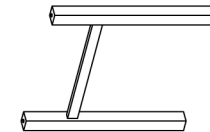

x1 RS496-414-FRAMEL \*  
Leg Frame (Left)  
Cadre De Jambe (Gauche)  
Marco De La Pierna (Izquierda)

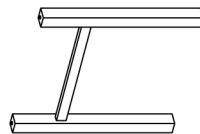

x1 RS496-414-FRAMER \*  
Leg Frame (Right)  
Cadre De Jambe (Droite)  
Marco De La Pierna (Derecha)



x1 RS496-414-STRE \*  
Bottom Stretcher  
Civière inférieure  
Camilla inferior

*\*Replaceable Part*

# **Protect Your Wood or Laminate Flooring**

\*This statement applies to any floor without carpet.

If not careful, all furniture including upholstery and case pieces can scratch, scuff and even gouge floors. The recommendation is to have felt, rubber pads or area rugs under furniture on flooring without carpet.

## **Moving your furniture**

Pushing and dragging furniture over floors without carpet can lead to scratches and scuffs. Have someone help when moving the larger pieces of furniture by lifting, try using a dolly or moving pads.

## **Felt and rubber pads**

Applying furniture pads to the feet of furniture helps cushion contact points. Furniture pads can be found at local hardware stores. Felt pads slide easily across the floor, making them ideal for dining chairs and other pieces that move with use. Rubber pads will help furniture stay in place and are perfect for larger pieces, like sofas and loveseats.

## **Area rugs and rug pads**

Using an area rug under furniture is another way to protect your floor from scratches and scuff marks. A rug pad under the area rug will provide extra cushion and added protection.