

**PARTS LIST / LISTE DES PIÈCES / LISTA DE PIEZAS**

DESCRIPTION / LA DESCRIPCION / DESCRIPCIÓN : NIGHTSTAND / TABLE DE CHEVET / MESA DE NOCHE

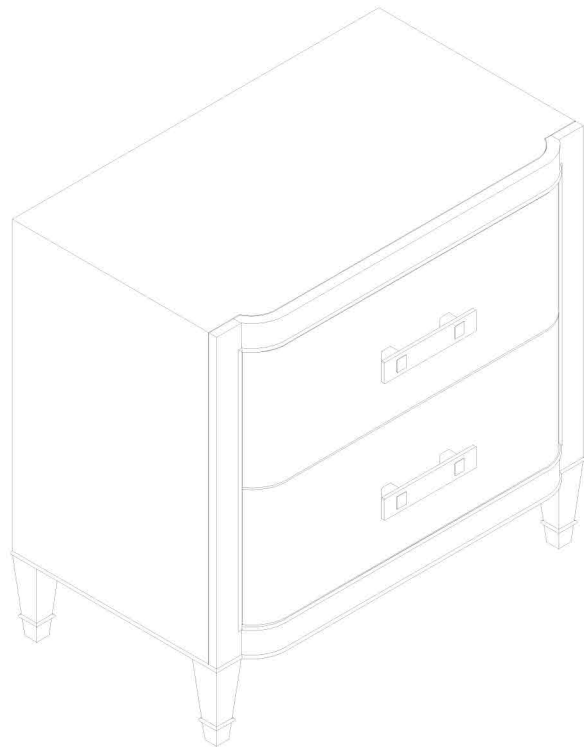

**(A)**

x1 Nightstand  
x1 Table de chevet  
x1 Mesa de noche



**(B)**

x4 Leg \*  
x4 Jambes  
x4 Piernas

\* *Replaceable Part*

1

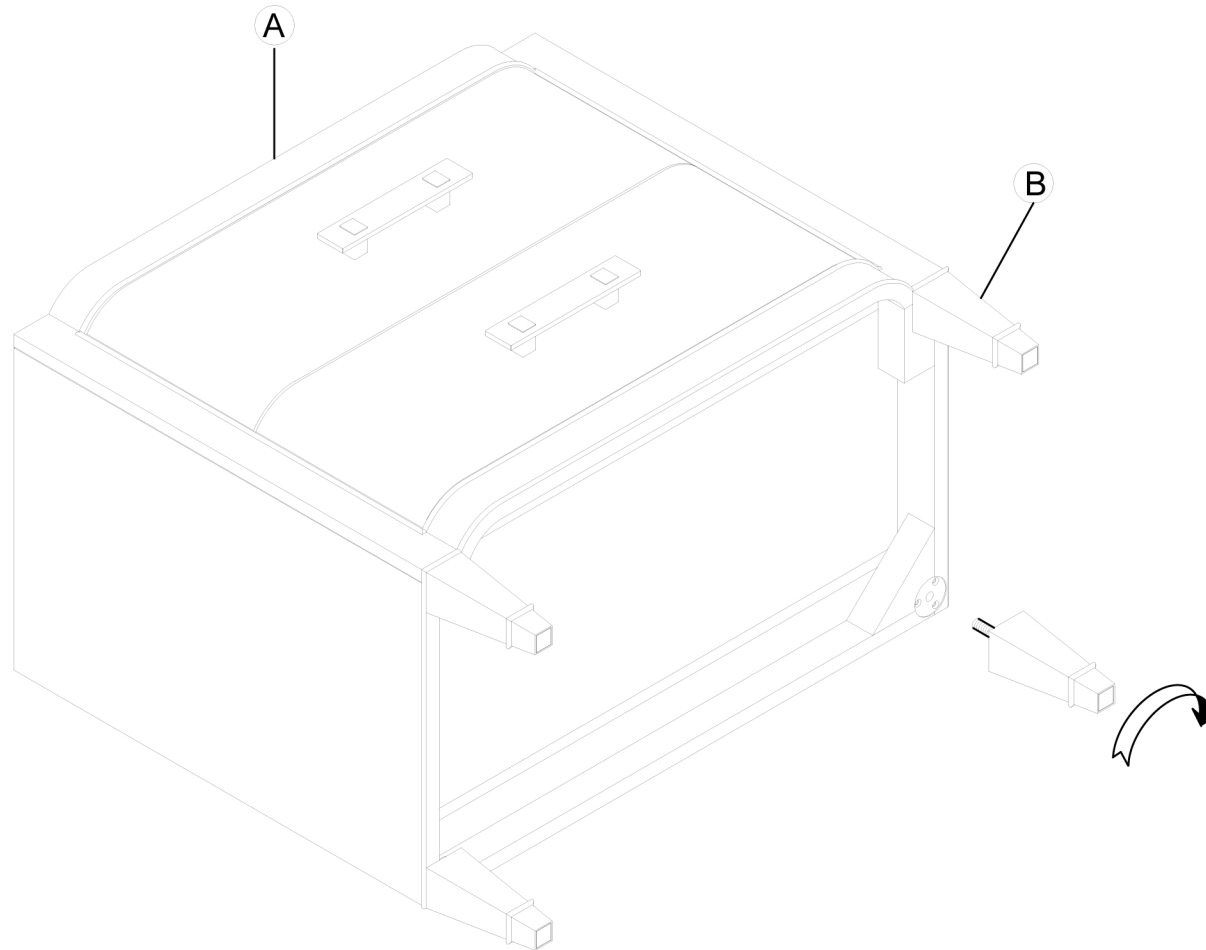

\* Replaceable Part

**REPLACEABLE PART / PARTIE REMPLAÇABLE / PARTE REEMPLAZABLE**

DESCRIPTION / LA DESCRIPCION / DESCRIPCIÓN : NIGHTSTAND / TABLE DE CHEVET / MESA DE NOCHE

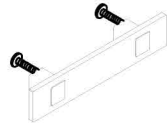
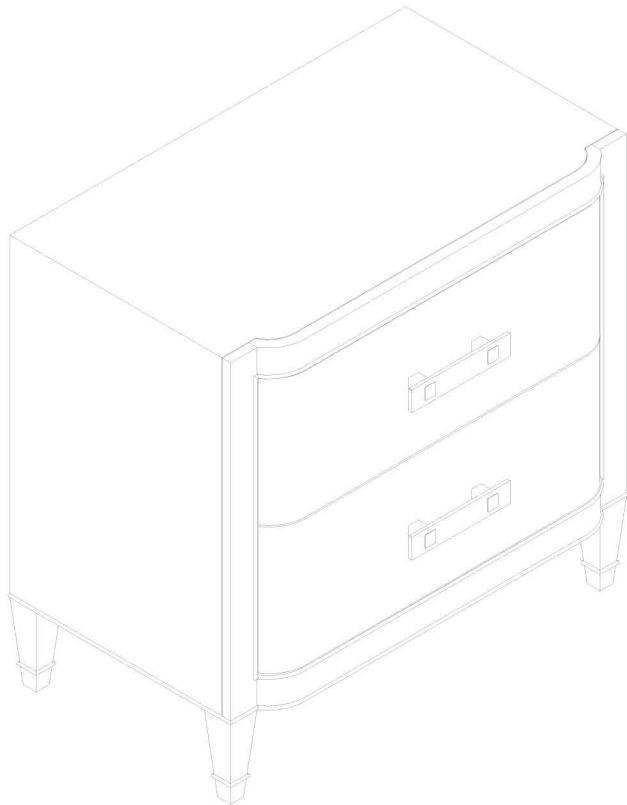

x2 RP344-PULL - Pull with Screw \*  
Poignée et vis  
Tirador y Tornillo



x2 COMGLIDE-10-45 - Common Glide 10in - 45mm \*  
Glissière  
Carril de deslizamiento

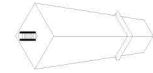

x4 RP344100-LEG - Leg \*  
Jambes  
Piernas

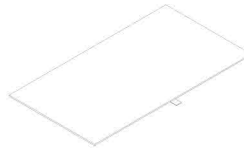

x1 RP344140-FELT - Removeable Felt \*  
Feutre  
Fieltro

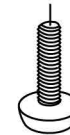

x4 RC-FG-WHITE - White leveler \*  
Patin réglable  
Nivelador

\* Replaceable Part

# Protect Your Wood or Laminate Flooring

\*This statement applies to any floor without carpet.

If not careful, all furniture including upholstery and case pieces can scratch, scuff and even gouge floors. The recommendation is to have felt, rubber pads or area rugs under furniture on flooring without carpet.

## **Moving your furniture**

Pushing and dragging furniture over floors without carpet can lead to scratches and scuffs. Have someone help when moving the larger pieces of furniture by lifting, try using a dolly or moving pads.

## **Felt and rubber pads**

Applying furniture pads to the feet of furniture helps cushion contact points. Furniture pads can be found at local hardware stores. Felt pads slide easily across the floor, making them ideal for dining chairs and other pieces that move with use. Rubber pads will help furniture stay in place and are perfect for larger pieces, like sofas and loveseats.

## **Area rugs and rug pads**

Using an area rug under furniture is another way to protect your floor from scratches and scuff marks. A rug pad under the area rug will provide extra cushion and added protection.