

SAFETY INFORMATION

Please read and understand this entire manual before attempting to assemble, install or operate the product.

- WARNING**
- RISK OF ELECTRIC SHOCK - Before beginning installation, turn off electricity at the circuit breaker box or the main fuse box.
 - RISK OF FIRE - Use bulbs specified by the markings and/or labels on the fixture.

- CAUTION**
- For your safety, read instructions completely before beginning installation.
 - If in doubt about electrical installation, consult a licensed electrician.
 - Turn off electricity to fixture before replacing the bulb(s).

TOOLS REQUIRED

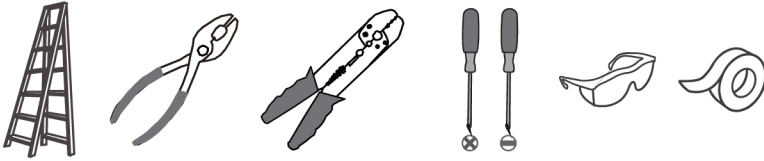

CARE AND MAINTENANCE

- Wipe clean using soft, dry cloth or static duster. Always avoid using harsh chemicals and abrasives to clean fixture as they may damage the finish.

PACKAGE CONTENTS

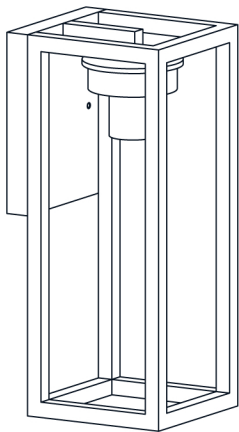

A Fixture Body
x 1



B Glass Shade
x 1

MOUNTING HARDWARE

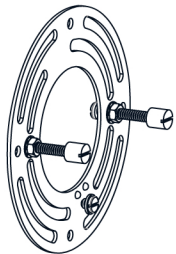

AA Crossbar Assembly
x 1



BB Alternate
Mounting Screw
x 2



CC Wire Connector
x 3



DD Outlet Box Screw
x 2

1 Install Inner Backplate

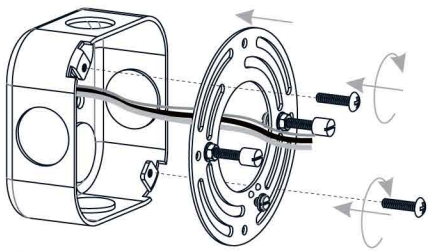

(2) Alternative Screws



* Alternative screws are provided to replace pre-assembled mounting screws if necessary.

2 Wiring

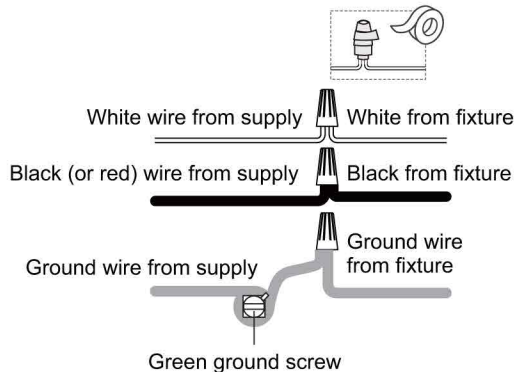

3 Install Fixture Body

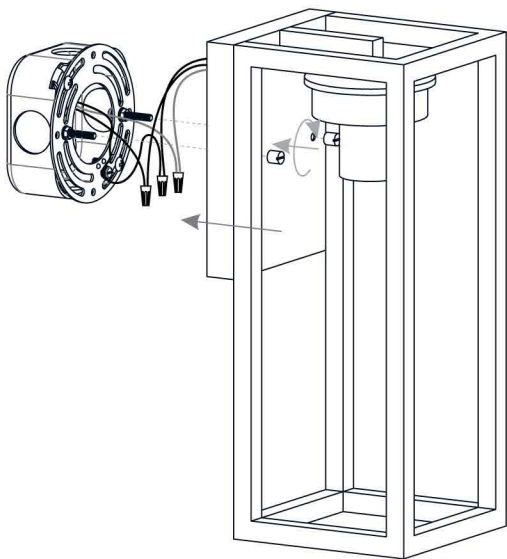

4 Install Bulb

Install the correct bulb referring to fixture markings and/or labels for maximum wattage.

Recommended Bulb Type (not included):

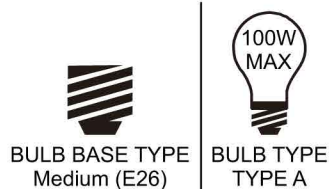

5 Install Glass Shade

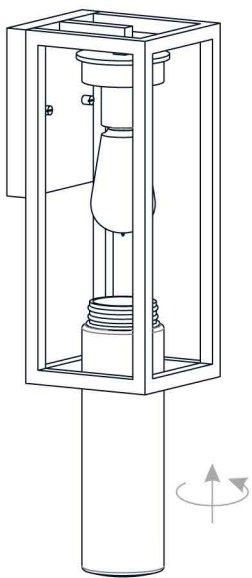

6 Apply Caulking

* Note: Do NOT caulk the bottom of the backplate to allow moisture to escape.

Downwards Installation

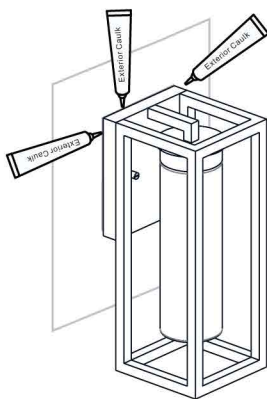

Upwards Installation

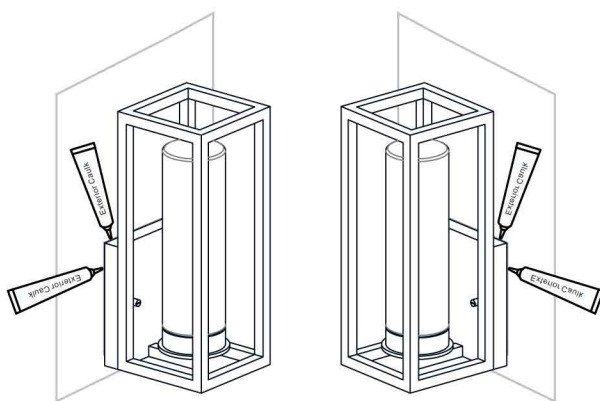

Your installation is now complete! Restore electricity and save this sheet for future reference.