

ASSEMBLY AND INSTALLATION INSTRUCTIONS

WARNING: TO AVOID RISK OF ELECTRICAL SHOCK, BE SURE TO SHUT OFF POWER BEFORE INSTALLING OR SERVICING THIS FIXTURE.

NOTES: 1. Before installing, consult local electrical codes for wiring and grounding requirements.
2. READ AND SAVE THESE INSTRUCTIONS.

Hardware Package (included):

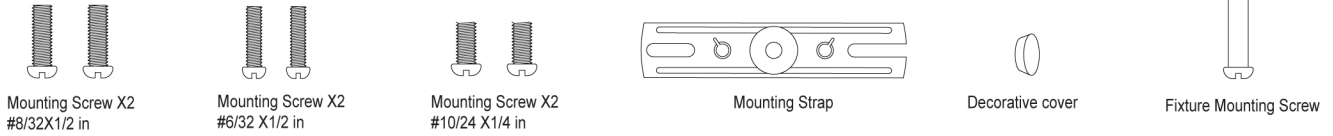

Tools Needed:



1. Phillips-head screwdriver for attaching mounting screws to mounting strap, mounting bracket and fixture to mounting bracket.
2. 1/8" wide flat-head screwdriver for connecting the source wires into the wiring terminal station on the mounting bracket.

Important to Know:

1. If you are not familiar with state and local electrical codes, it is recommended that you consult with a qualified electrician.
2. This fixture requires a 120 VAC, 60 Hz power source.
3. For general safety and to avoid any possible damage to the sensor, be sure the power is switched "off" before adjustment.

Maximum Wattage: 22 W

Working Temperature Range: -13°F ~ 113°F

Features:

1. Energy saving LED fixture.
2. Motion sensor: turns light ON at full brightness automatically when motion is detected and DIMS light to low level brightness automatically when motion stops.
3. Photocell automatically keeps the light OFF during daylight hours and automatically turns the light ON during evening hours.
4. The wall switch that the light is connected to can be used to manually override and change functionality and settings of certain modes.

Note: Fixture can be wall mounted or eave mounted.

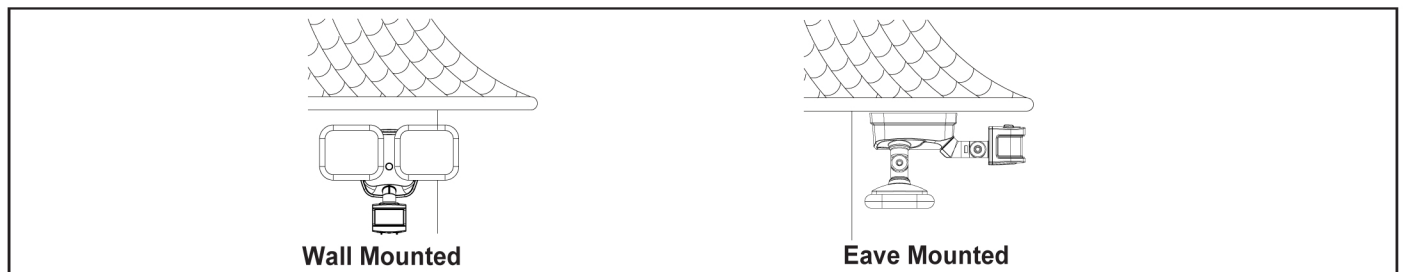

Read notes section on page 4 for additional information about mounting location of fixture.

Light fixture and sensor should be mounted as shown above when installed (depending upon type of installation)

Before installing the light fixture under an eave, the sensor head must be rotated as shown in the next two steps for proper operation and to avoid the risk of electrical shock.

For eave mounted only:

- Swing the sensor head towards the mounting bracket.

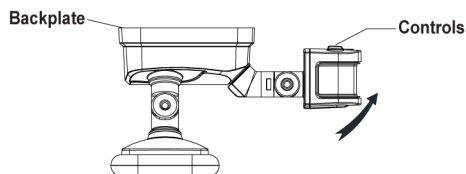

- Rotate the sensor head clockwise 180° so the controls face down.

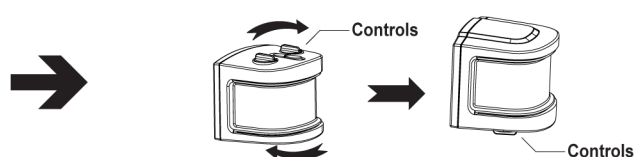

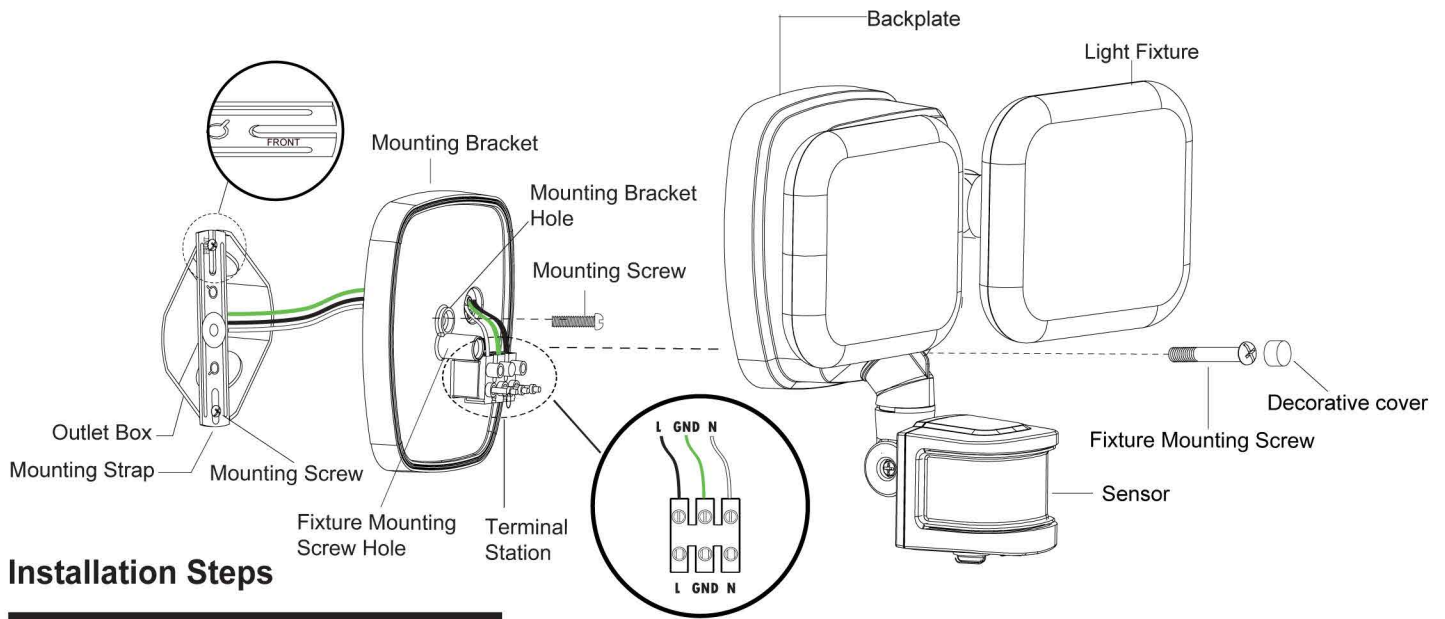

Installation Steps

Turn off the power at fuse or circuit box.

1. The fixture mounting bracket is pre-assembled on the light fixture. Unscrew both the decorative cover and the fixture mounting screw in order to remove the mounting bracket.
2. Install the mounting strap to the outlet box with the stamped word "FRONT" facing away from the outlet box, using two mounting screws that best fit the outlet box. Mounting bracket should sit flush against wall surface when secured. (Choose one matching pair of suitable mounting screws from the 3 pairs provided).
3. Pull out the source wires from the outlet box. Using a 1/8" flat-head screwdriver connect the black wire from the outlet box to the "L" interface of the terminal station on the mounting bracket. Connect the white wire from the outlet box to the "N" interface of the terminal station on the mounting bracket. Connect the Ground wire from outlet box to "GND" interface of the terminal station on the mounting bracket. Carefully tuck the wires back into the outlet box.
4. Place mounting bracket against the outlet box, insert the mounting bracket screw through the mounting bracket hole, thread mounting bracket screw into the center hole of the mounting strap. Tighten the mounting bracket screw securely.
5. Attach the backplate of the light fixture to the mounting fixture mounting screw. Then push the decorative cover firmly into the fixture mounting screw hole on the light fixture. Tighten the fixture mounting screw securely.
6. With silicone caulking compound, caulk completely around where the back plate meets the wall surface.
CAUTION: Be sure to caulk completely where the back plate meets the wall surface to prevent water from seeping into the outlet box.

Turn on the power at the main fuse or circuit breaker box.

Adjusting the Sensor Head:

1. Aim sensor head toward desired detection area, maintaining a 5° - 40° downward angle to allow moisture to drain.
 Note: Make sure sensor head is positioned with control knob facing towards the ground.
2. You can rotate the sensor head up and down to change the coverage area. (See Fig. 1)
Note: Range set too high may increase false triggering.
 (See Fig. 2 and Fig. 3)

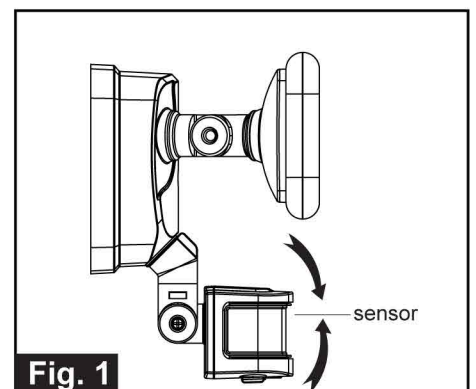
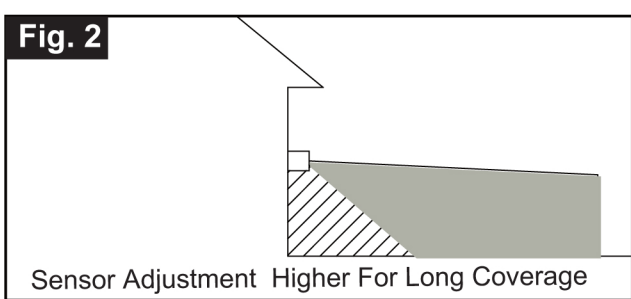
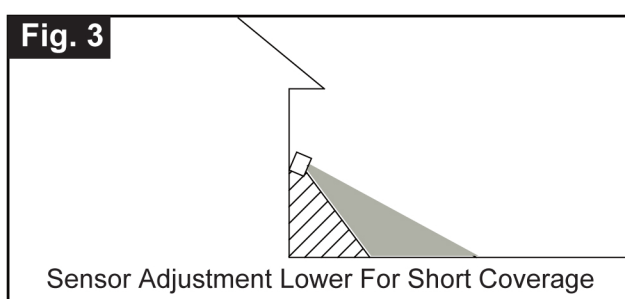
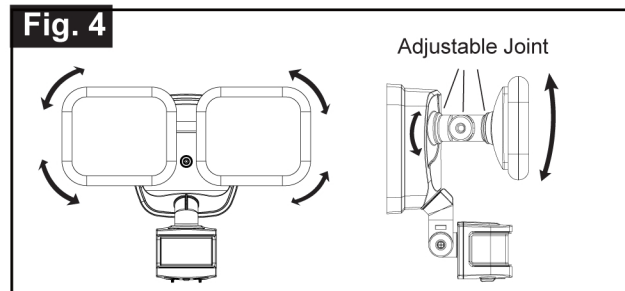

Fig. 1

Fig. 2**Fig. 3**

Adjusting the Light Head:

1. Both lamp heads can be adjusted to point towards your desired light coverage area by turning and bending the Adjustable Joint.
2. Keep the light heads at least 1" (25mm) away from the sensor. (See Fig. 4)
3. Keep the light heads 30° below horizontal to avoid water damage and electrical shock.

Fig. 4

Sensitivity of Motion Sensor

- You can adjust the sensitivity of the motion sensor by using the "SENS"
- Adjust motion sensor sensitivity to HIGH (H), MEDIUM (M), or LOW (L) to achieve desired performance.
- Approximate range for each setting: 70 ft. (H), 50 ft. (M), 30 ft. (L).

Choose a mode by rotating the switch on the bottom of the sensor of the fixture. (See Fig.5)

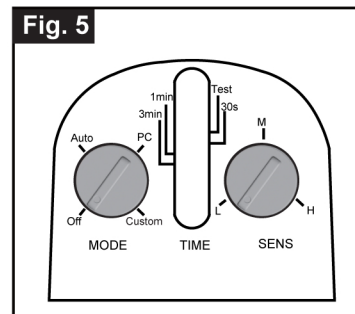
Fig. 5

Modes of Motion Sensor

Note: When power is first applied, the light will be on and warm up lasts 30 seconds.

1. TEST MODE (daytime and nighttime operation.)
 - Slide the Time switch to the "Test" position.
 - The light turns to high-level brightness (5000K) when motion is detected. Then it reverts back to low-level brightness and CCT color 2700K as per setting about 5 seconds after motion is no longer detected.
2. PC MODE (nighttime operation only)
 - In "PC" mode, the light turns on at full brightness at dusk and remains on until dawn.
3. OFF MODE (nighttime operation only)
 - Select "OFF" on mode switch, slide the Time Delay knob to the desired shut-off delay time (30s/1min/3min).
 - At dusk, the light will remain off, the light will turn on to high-level brightness (at 5000K) whenever motion is detected, and stays on as long as motion continues.
 - When the motion is no longer detected, it will remain on for the predetermined shut-off delay time you set (30s/1min/3min), and then will turn off automatically.
 - The light will not turn on if motion is detected after dawn.
4. AUTO MODE (nighttime operation only)
 - Select "AUTO" on mode switch, slide the Time switch to the desired shut-off delay time setting (30s/1min/3min).
 - At dusk, the light turns on to low-level brightness 30% (2700K). When motion is detected, the light turns to full brightness (5000K) and stays on as long as motion continues.
 - When the motion is no longer detected, the light will remain on at full brightness (5000K), for the predetermined time you set (30s/1min/3min), and then automatically switch back to low-level brightness 30% (2700K).
 - At dawn, the light turns off automatically.

5. CUSTOM MODE (nighttime operation only):

- Select "CUSTOM" on mode switch, slide the Time switch to the desired shut-off delay time setting (30s/1min/3min).
- At dusk, the light will initially turn on in early evening setting, at full brightness (2700K), and off at dawn automatically.
- To set a specific time for the light to transition into late night setting and initiate motion sensor operation you will utilize the wall switch to which the light is connected. During late night setting, the light will transition to low level setting (30% brightness at 2700K) and brightens instantly to full brightness at 5000K whenever motion is detected.
- To set the specific transition time, turn the wall switch to "OFF", and back to "ON" two times within 3 seconds. The light will remember that time and go into late night setting/motion-sensor operation at that specified time every night.
- For example, a homeowner wants to have the light stay on at full brightness (2700K) from dusk to 8pm and would then like the light to go into late night/ motion sensor mode from 8pm until dawn. To achieve this, the homeowner turn the wall switch "OFF" and "ON" twice within 3 seconds at 8pm. This sets the time the light goes into late night/ motion sensor mode every day at 8pm.
- When motion is detected, the light turns to full brightness (5000K) and stays on as long as motion continues. When motion is no longer detected, the light will remain on at full brightness (5000K) for the predetermined time you set (30s/1min/3min), and then automatically switch back to low-level brightness 30% (2700K).
- To revert the light back to Default, turn the wall switch "OFF" and then turn it back "ON" after 5 seconds.

Note: The default setting will be the same function as "PC Mode" if no specific transition time is set

6. MANUAL OVERRIDE (nighttime operation only)

- To temporarily override the settings when in "AUTO" mode for on-demand continuous high-level brightness at night, turn the wall switch "OFF" then "ON" twice within 3 seconds, the light will then remain on all night long.
- To shift back to "AUTO" mode, turn the wall switch "OFF" then "ON" twice within 3 seconds again. (See Fig.6)
- The light turns off automatically at dawn.

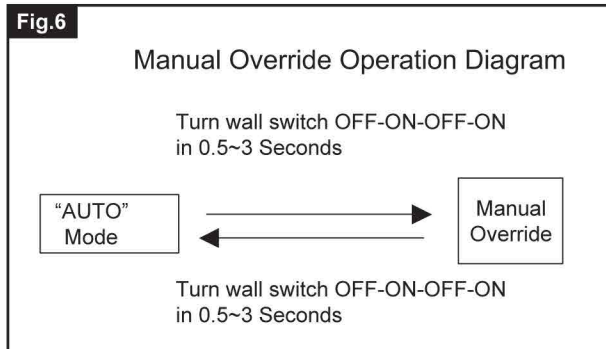

Performance Notes:

1. The sensitivity of the motion sensor will increase as the environmental temperature gets cooler. You may wish to make adjustments when the season changes. For best performance, gently clean the lens with a soft cloth every 1 or 2 months to assure maximum sensitivity.
2. For best performance, install fixture at least 8 feet above the ground. At such a height, the fixture will provide a detection distance of up to 70 feet at 77 degrees Fahrenheit. (See Fig.7)
3. The sensor detects movement across a detection range of 180 degrees. (See Fig.8)
4. The sensor will be more sensitive to motion across its detection path than motion directly towards it. (See Fig.9)
5. To reduce possible nuisances, do not mount the fixture near a heat source like an air conditioner, vent or furnace exhaust, or in a direction facing any reflecting object or other light source.

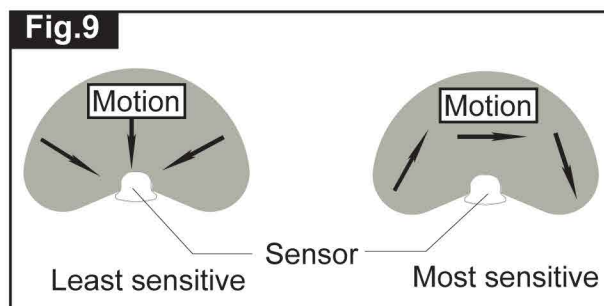
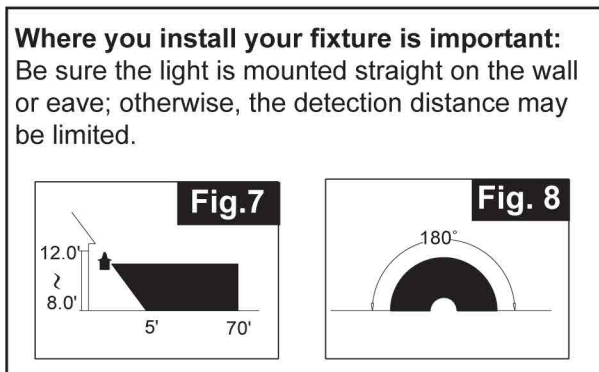

Troubleshooting

---The light does not come on at all:

1. Make sure the wall switch and circuit breaker are on.
2. Make sure the wiring is correct.
3. Cover the sensor with dark color cloth to verify that the ambient light level is not too high.

---The light comes on for no apparent reason

1. Re-aim the motion sensor.
2. Decrease the sensitivity setting.
3. Do not use a dimmer or timer to control the light fixture. Replace the dimmer or timer with a standard on/off wall

---The light flashes on and off:

1. Reposition the bulb away from the motion sensor.
2. Reposition the motion sensor.
3. The motion sensor is in "TEST" mode and warm up.

The following parts are available for re-order if damaged or missing. Call our toll free at 1-800-887-6326.

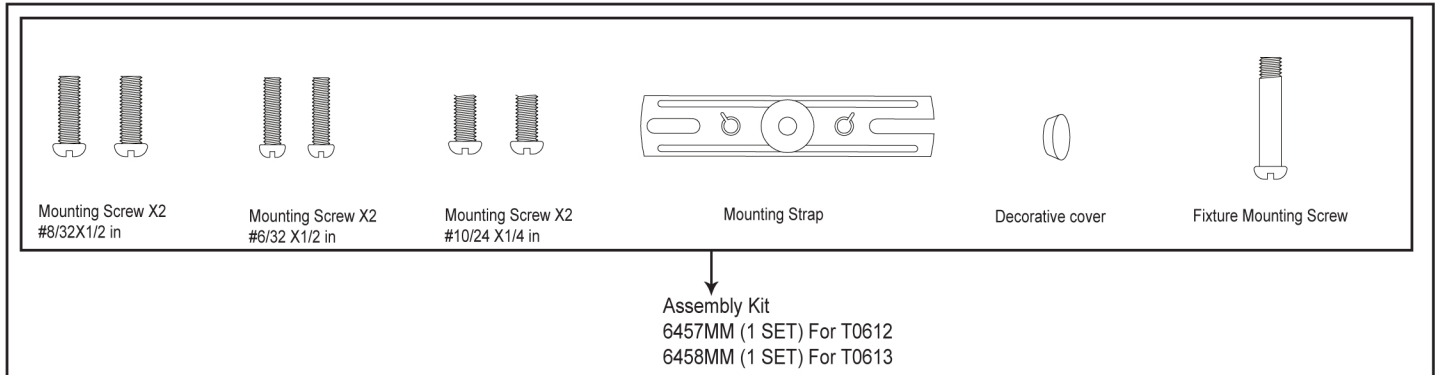

5-YEAR LIMITED WARRANTY:

All products are warranted to be free of defects in material and workmanship for five (5) years from date of purchase. This warranty is limited to the correction of any such defect, or the replacement of any such defective item(s), provided that: (a) we are properly notified and consent to return of the item(s) in question; (b) the item(s) is / are returned with proof of purchase date; and (c) it is found upon inspection by us that the item(s) is / are defective as noted above. This warranty does not cover labor costs, consequential damages, nor does it apply to any item(s) that have been improperly installed, overloaded, altered, or otherwise abused by the customer, its agent(s) or employee(s). Finishes are specially excluded from the terms of this warranty since they are subject to environmental maintenance deemed beyond our control. Other than the described obligation, we assume no further liability with respect to the sale or use of our products. We make no warranty, express or implied, and disclaim any warranty of merchantability or fitness for a particular purpose.

