

CORAMDEO LIGHTING

LED INDOOR LIGHTING

Models: C023-83050LED-BRZ
C023-83050LED-PNK

Dimensions

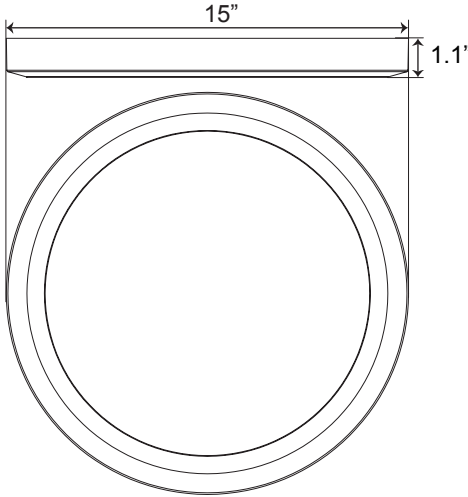

Specifications

Power Specs	
Input Voltage	120VAC
Frequency	60Hz
Input Current	<223 mA
Power	21.5 W
Efficiency	>85
Power Factor	≤ .9

Light Specs	
Color Temp	3K, 4K, 5K
Color Temp	3K Warm White
	4K Bright White
	5K Daylight White
Lumens (lm)	2100 lm
CRI (Ra)	>80
Lumens per Watt	98
Beam Angle	120 °
Life Span	50,000 hrs

Functions



Dimming typically ranges from 10% to 100% of brightness. Compatible with most modern electronic dimmers but may not be compatible with every electronic dimmer. Please see SolanaLighting.com for specific dimmer compatibility listings.

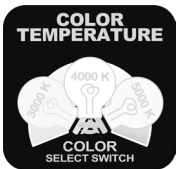

Choose your preferred color temperature between 3K (Warm White), 4K (Bright White) and 5K (Daylight White) with switch installed on this fixture.



Certifications



This fixture has been manufactured in accordance to ETL and UL requirements

CORAMDEO
LIGHTING
12891 Wetmore Rd.
San Antonio, TX 78247

© Copyright 2023 All rights reserved

This device complies with part 15 of the FCC Rules. Operation is subject to the following two conditions: (1) This device may not cause harmful interference, and (2) this device must accept any interference received, including interference that may cause undesired operation. Note: This equipment has been tested and found to comply with the limits for a Class B digital device, pursuant to part 15 of the FCC Rules. These limits are designed to provide reasonable protection against harmful interference in a residential installation. This equipment generates, uses and can radiate radio frequency energy and, if not installed and used in accordance with the instructions, may cause harmful interference to radio communications. However, there is no guarantee that interference will not occur in a particular installation. If this equipment does cause harmful interference to radio or television reception, which can be determined by turning the equipment off and on, the user is encouraged to try to correct the interference by one or more of the following measures: Reorient or relocate the receiving antenna; Increase the separation between the equipment and receiver; Connect the equipment into an outlet on a circuit different from that to which the receiver is connected. Consult the dealer or an experienced radio/TV technician for help.

Drawings not to scale

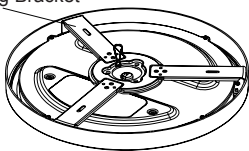
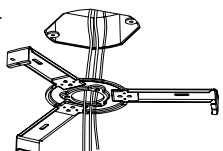
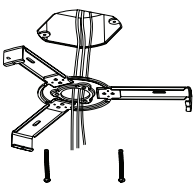
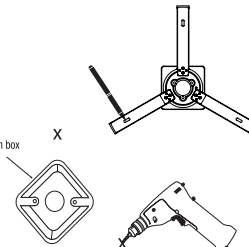
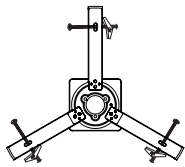
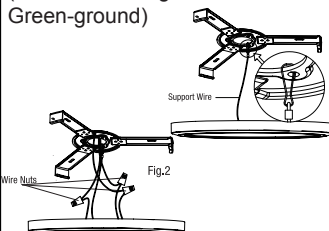
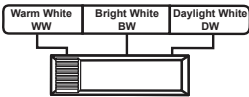
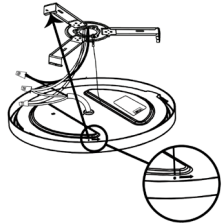
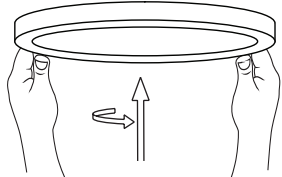
<p>1. Unlock and separate the Mounting Bracket from the fixture by turning it clockwise.</p> <p>Mounting Bracket</p> 	<p>2. Turn off power at circuit breaker or fuse. Pull electrical wiring from junction box (Green-ground, Black-line voltage, White-neutral) through center of mount bracket.</p> 	<p>3. Attach Mounting Bracket to Junction Box with supplied screws. If securing bracket ends into ceiling (optional) continue steps 4-6.</p> 
<p>4. Mark holes in bracket ends, remove bracket, then drill marked holes with 3/8" bit.</p> 	<p>5. Assemble toggle bolts on each bracket end, then re-attach bracket to junction box following above steps. Insert toggle bolts into each hole and tighten screws</p> 	<p>6. Hook up support wire to hold fixture while you connect fixture to junction box wires with wire nuts (Black-line voltage, White-neutral, Green-ground)</p> 
<p>7. Select your desired Color Temperature on the switch located on the bottom of the fixture:</p> 	<p>8. Line up dots on underside of fixture to each bracket arm.</p> 	<p>9. Attach fixture to bracket arms by twisting the fixture clockwise. Make sure fixture is secure before turning on power at source.</p> 

IMPORTANT SAFETY INFORMATION



This product may represent a possible shock or hazard if improperly installed or attached in any way. Product should be installed in accordance with the owners manual, current electrical codes and the National Electric Code (NEC).

RISK OF ELECTRIC SHOCK: TURN OFF THE MAIN POWER AT THE CIRCUIT BREAKER BEFORE INSTALLING

WARNING: RISK OF SHOCK - ALWAYS REMEMBER TO:

- Turn off power at fuse or circuit breaker BEFORE installing fixture.
- DOUBLE CHECK all connections to make sure they are safe and tight.
- Wear rubber soled shoes and work on a grounded ladder.

If you are unsure about your wiring, consult a qualified electrician for installation of fixture.

WARNING: RISK OF CUTS

Some metal parts or edges may have sharp edges. Prevent injury by using gloves when handling.

ACCOUNT FOR SMALL PARTS and DESTROY PACKING MATERIAL that may be hazardous to children.