

BALDWIN®



KEYLESS ENTRY WITH HOME CONNECT™ TECHNOLOGY

Baldwin brings home automation to the front door with the addition of Home Connect™ technology. This fully automated motorized deadbolt secures your home with a new level of functionality that provides security and convenience and wirelessly communicates with other devices in your home.





Home Connect™ Technology

Baldwin's Home Connect Technology enables the door lock to wirelessly communicate with other devices in the home.

Check lock status remotely, lock or unlock your home with a cell phone. Receive a text message when your child arrives home. Unlock your door, disarm the alarm, and turn on the lights, all with the click of a button. Baldwin's keyless locks meet the demanding needs of the modern family.

Innovative Security

- Motorized deadbolt for true remote locking
- Revolutionary tapered deadbolt design
- Full 128-Bit encryption security

Easy Integration

- Installs in minutes
- Replaces existing deadbolt
- Uses 4 AA batteries (no hard wiring)
- Z-Wave wireless protocol

Home Connect integration delivers the following benefits:

Remote access advantages

- Lock/unlock doors via smart phone or internet connection while away
- Receive remote notification when door lock is accessed
- Check lock status remotely to see if doors are locked



Home control benefits

- Customize lighting scenes for convenience through lock keypad
- Initiate thermostat away mode when leaving home and locking door
- Save money while conserving energy usage through home/away modes via lock keypad

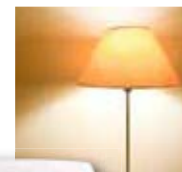

Security system enhancements

- Simplify security system control through lock keypad
- Control locks from security system to lock/unlock door while arming/disarming
- Single button security system arming via lock keypad



Contact your local Dealer/Distributor for details.



Z-Wave Wireless Protocol

BALDWIN®

**BOULDER
DEADBOLT**

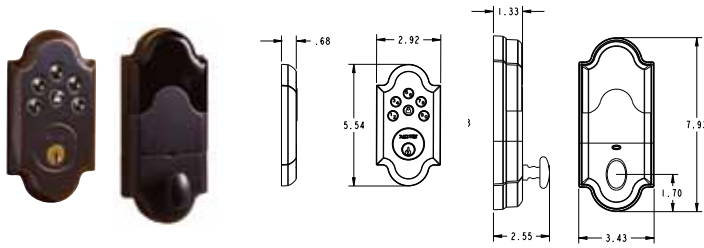

Item #	Description	Tier 1 102, 112	Tier 2 003, 402
8252.xxx.AC3	AC Z-Wave Deadbolt	\$565	\$595

**BOULDER
SECTIONAL
HANDLESET KIT**

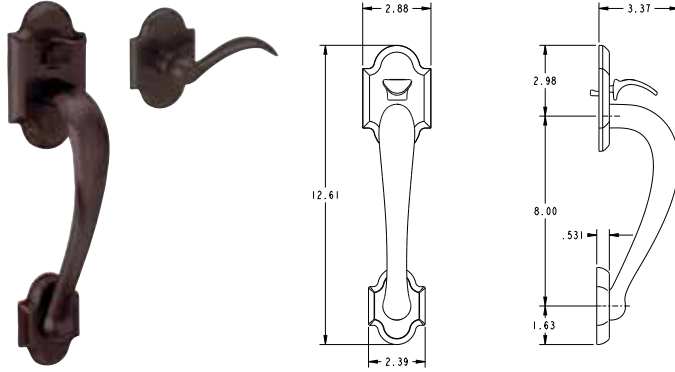

Item #	Description	Tier 1 102, 112	Tier 2 003, 402
85353.xxx.ACRH	Sectional Entry Handleset Kit	\$335	\$350
85353.xxx.ACLH	Sectional Entry Handleset Kit	\$335	\$350

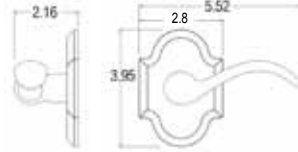

**BOULDER 3/4
ESCUTCHEON
HANDLESET KIT**

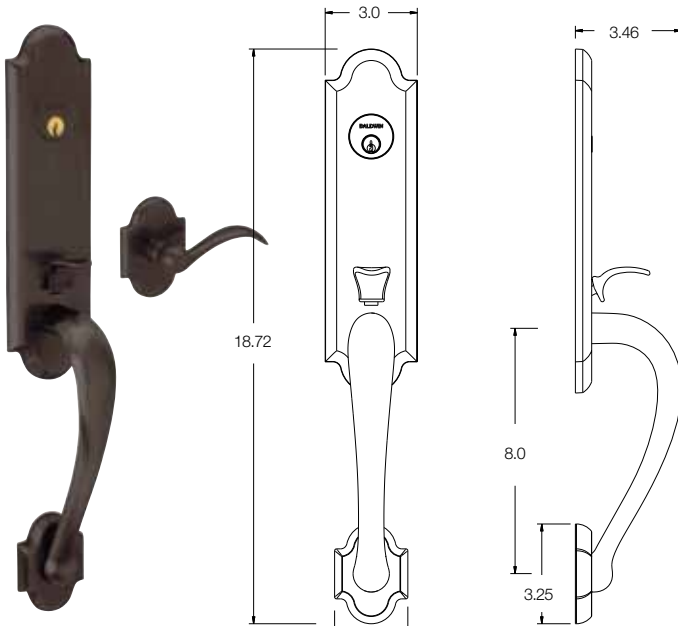

Item #	Description	Tier 1 102, 112	Tier 2 003, 402
85354.xxx.ACRH	3/4 Entry Handleset Kit	\$510	\$535
85354.xxx.ACLH	3/4 Entry Handleset Kit	\$510	\$535

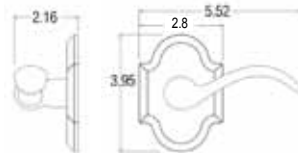

**BOULDER
NON-KEYPAD
DEADBOLT KIT**

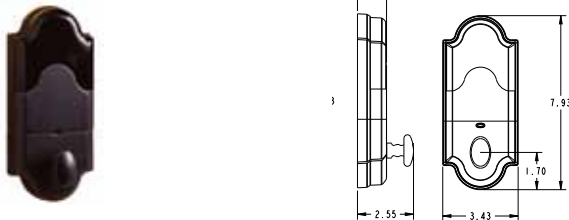

Item #	Description	Tier 1 102, 112	Tier 2 003, 402
8252.xxx.AC3X	AC Z-Wave Deadbolt without Keypad	\$565	\$595

BALDWIN®

**SOHO
DEADBOLT**

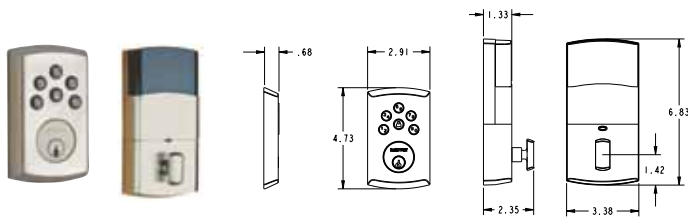

Item #	Description	Tier 1 150, 260, 264	Tier 2 056
8285.xxx.AC3	AC Z-Wave Deadbolt	\$565	\$595

**SOHO
SECTIONAL
HANDLESET KIT**

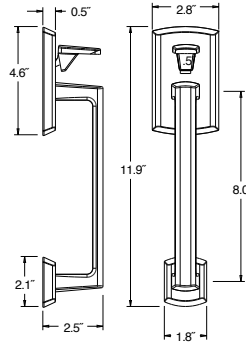

Item #	Description	Tier 1 150, 260, 264	Tier 2 056
85386.xxx.ACRH	Sectional Entry Handleset Kit	\$335	\$350
85386.xxx.ACLH	Sectional Entry Handleset Kit	\$335	\$350

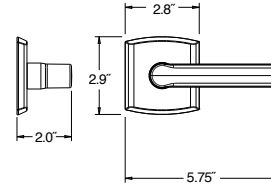

**SOHO 3/4
ESCUTCHEON
HANDLESET KIT**

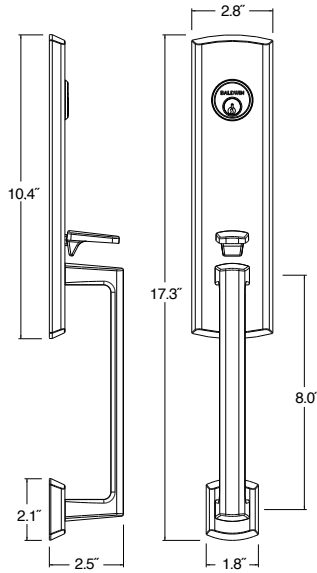

Item #	Description	Tier 1 150, 260, 264	Tier 2 056
85387.xxx.ACRH	3/4 Entry Handleset Kit	\$510	\$535
85387.xxx.ACLH	3/4 Entry Handleset Kit	\$510	\$535

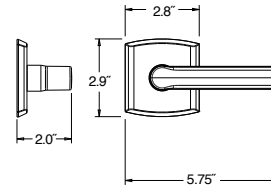

**SOHO NON-
KEYPAD
DEADBOLT KIT**

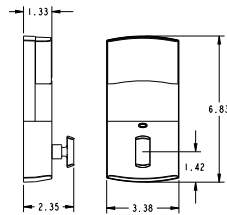

Item #	Description	Tier 1 150, 260, 264	Tier 2 056
8285.xxx.AC3X	AC Z-Wave Deadbolt without Keypad	\$565	\$595

BALDWIN®



8285.xxx.AC3
Soho Z-Wave
Deadbolt



8252.xxx.AC3
Boulder Z-Wave
Deadbolt



85386.xxx.ACLH (.ACRH)
Soho Sectional Trim
w/ 5485 Lever



85353.xxx.ACLH (.ACRH)
Boulder Sectional Trim
w/ 5452 Lever

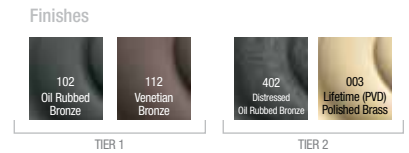

* Product shown in
150 Satin Nickel Finish

* Product shown in
112 Venetian Bronze Finish

Keyless Entry Deadbolt Features

- Easy Install in Minutes with Screwdriver
- Fits Standard Door Prep
- No Hard Wiring Required
- 30 Customizable User Codes with Easy Add & Delete
- 4 to 8 Digit Codes
- One Touch Locking
- Back-Lit Keypad for Increased Visibility
- Incorrect Code Lockout Feature
- Customizable Features
 - Automatic Door Locking after 30 Seconds
 - Door Locked / Unlocked LED Indicator
 - Audible Beep for Activation
- 4 AA Batteries Required
- Low Battery LED Indicator
- Motorized Deadbolt for True Remote Locking
- Tapered Deadbolt Design
- Protected Coated Keypad Preventing Wear & Discoloration
- Automatic Handing Feature
- Solid Forged Brass Trim

Keyless Entry Deadbolt Specifications

Function	Single Cylinder Deadbolt
Door Prep	2 1/8" Bore, 1" Edge Bore
Backset	Adjustable 2 3/8" or 2 3/4"
Door Thickness	1.75" to 2.00"
Cylinder	5-Pin C-Keyway
Faceplate	1" Square Corner
Strike	Square Corner with reinforcing plate
Latch	1" Throw
Bolt	Brass, tapered w/ security pin
Door Handing	Automatic Handing
Key	C-Keyway, not compatible with Kwikset K-Keyway

BALDWIN®

FAQ LIST

KEYLESS ENTRY WITH HOME CONNECT™ TECHNOLOGY

Does this product require a different installation?

No, fits a standard tubular deadbolt prep.

What is the estimated life of the batteries?

Approximately 1 year of standard use.

Are there issues with the motorized bolt in regards to weatherstripping expansion?

The tapered bolt design was implemented in order to address these conditions.

Can I get additional finishes or split finishes?

No, these products cannot be extended into additional finishes or split finishes at this time.

Are Keyed Alike sets offered?

No, not at this time. Product will need to be rekeyed in the field.

What is the Warranty?

The Keyless Entry Deadbolts carry a Standard Estate Mechanical & Finish Warranty & a 1 Year Electronic Warranty.

What keyway is used?

'C' keyway and cannot be keyed alike with a Kwikset 'K' keyway product.

Are batteries included?

No, AA batteries are not included and will need to be purchased separately.

Where can I find more info about Baldwin products?

Go to our website, www.baldwinhardware.com. It includes a certified Baldwin showroom locator for additional hardware needs.

BALDWIN®

HOW TO ORDER

KEYLESS ENTRY WITH HOME CONNECT™ TECHNOLOGY

To Order Only a Deadbolt, Simply Order & Specify the Finish:



Example: 8285.150.AC3

*Ex: 8285.xxx.AC3, *xxx denotes finish*

To Order Sectional Handleset, Order Both Deadbolt & Sectional Handleset Kit (with Handing) & Specify the Finish:



Example: 8285.150.AC3 + 85386.150.ACLH

*Ex: 8285.xxx.AC3 & 85386.xxx.ACLH, *xxx denotes finish*

To Order 3/4 Escutcheon Handleset, Order Both 3/4 Escutcheon Handleset Kit (with Handing) & Non-Keypad Deadbolt Kit & Specify the Finish:



Example: 85387.150.ACLH + 8285.150.AC3X

*Ex: 85387.xxx.ACLH & 8285.xxx.AC3X, *xxx denotes finish*

Handing:

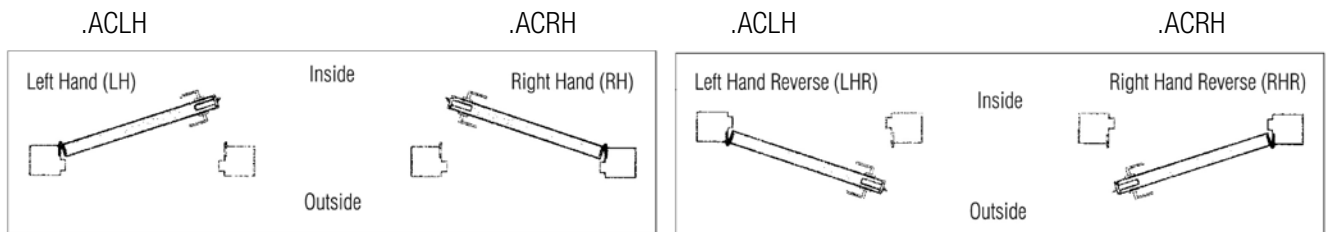

Handing determined by location of hinges. (LH) hinges are on the left & (RH) hinges are on the right.

BALDWIN®

WARRANTY & FINISHES

KEYLESS ENTRY WITH HOME CONNECT™ TECHNOLOGY

Limited Lifetime Mechanical Warranty: Baldwin warrants that each Baldwin product shall be free of mechanical defect for the original purchaser for as long as you own your home.

Limited Lifetime Finish™ Warranty: The Baldwin Lifetime Finish uses advanced finishing technology (physical vapor deposition) to create a finish highly resistant to the effects of weather & normal wear & tear. The Limited Lifetime Finish Warranty on Lifetime Finish™ products covers the original purchaser for as long as you own your home.

Limited Finish Warranty: The finish on Baldwin products (excluding Lifetime Finish & living finish products) is protected by a durable topcoat designed to maintain the beauty & quality of the Baldwin product. The Baldwin Limited Finish Warranty covers the original purchaser for five years from date of purchase for interior use & one year for exterior use.

Living Finishes: Due to the nature of Baldwin living finish products, they will wear over time & may already have begun the process before reaching your home. No finish warranty is offered on living finish products, which are designed to age & improve over time. Living finishes include raw brass, oil rubbed bronze, stainless steel, & other nonlacquered or non-PVD finishes.

One Year Electronics Warranty

Refer to www.baldwinhardware.com for a complete warranty statement.









Lifetime PVD Finishes:

All Lifetime finishes are not alike. Baldwin developed the first Lifetime PVD finish more than 20 years ago & it continues unmatched today. That's why we back it up with an industry-best Lifetime Finish Warranty.

Baldwin's patented PVD (Physical Vapor Deposition) finishing uses a sophisticated formulation of layered nickel alloys to create crisp detailing & brilliantly pure color. It interrupts the aging process & provides outstanding resistance to corrosion in even the harshest salt air environments.



Finishes:

<p>003 Lifetime Polished Brass</p>  <p>The original Baldwin Lifetime Finish creates a surface highly resistant to the effects of weather and normal wear and tear.</p>	<p>102 Oil-Rubbed Bronze</p>  <p>Oil-rubbed bronze is a living finish. It is unlacquered & designed to weather & change with age. This results in wear patterns as the finish rubs off in highly-used areas, & darkens in others.</p>	<p>112 Venetian Bronze</p>  <p>A lush, hand-relieved matte lacquered finish, varying in luster and hue as a result of handcrafted variances in the final finishing step.</p>	<p>402 Distressed Oil-Rubbed Bronze</p>  <p>Ruggedly tumbled to highlight details and bring an age-worn dimension to the lustrous texture of oil-rubbed bronze.</p>
<p>150 Satin Nickel</p>  <p>The Satin Nickel finish is nickel plating on brass that has been dulled & lacquer coated. Satin Nickel is sometimes referred to as brushed nickel. It is similar in appearance to brushed stainless steel or brushed aluminum.</p>	<p>056 Lifetime Satin Nickel</p>  <p>A robust PVD finish to resist extreme weather and salt air, similar in appearance to our Satin Nickel.</p>	<p>260 Polished Chrome</p>  <p>The integrity of solid brass plated in highly polished chrome for a stunning mirror smooth finish.</p>	<p>264 Satin Chrome</p>  <p>Satin silver finish, polished, and plated on brass.</p>

BALDWIN®