

hansgrohe

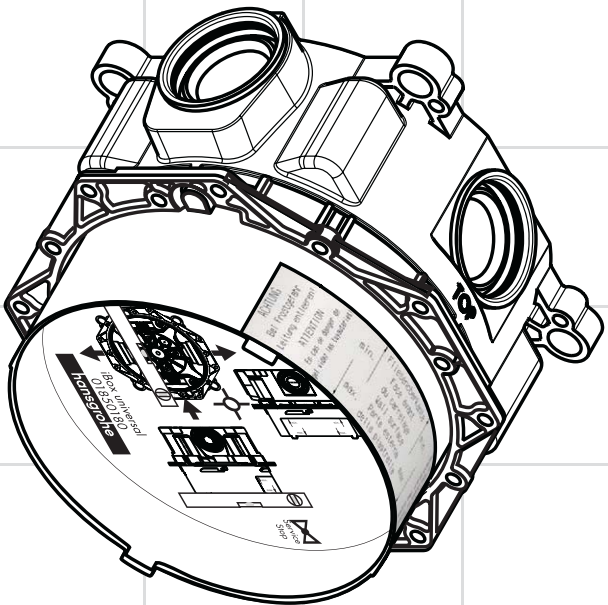

iBox universal

01850180

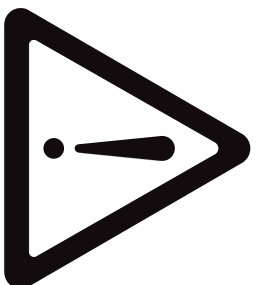
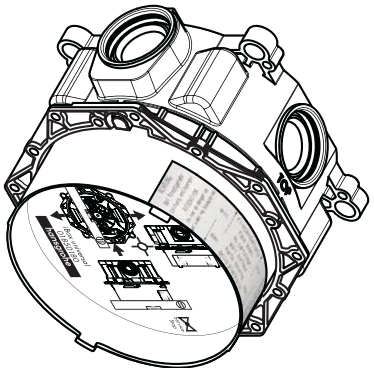

Vordsperrung pointeau d'arrêt Isolation valve Rubineth arresto Válvula de cierre Vóratstülper Forspærre Válvula de isolamento Oddzielacz wstępny izolaci ni venili Uzatvárací venilí	Säkerhetspörr Uzdatumo vozlvvas Prednaja izolaci ja On kesme Venilí de închidere la intrare Διπαράη προκαταβολικής φραγής Izolacijski venilí eellökésti Izoláci jas värsis Pehhodna blokada Forhåndsperre Предварительно блокиране Blöckimi ratararak
schließen / ferme / close / chiudere / cerrar / shtien / lukke / fechar / zamykat' / zavít / uzavret' / 关 / закрыть / bezárás / sulkeminen / stänga / uždaryti / Zshvanen / kapatmak / închide / κλειστό / zapretí / sulgege / aizvērt / zavori / lukke / zastvarne / mbylle / علق	Предварительная блокировка Είλεζάρás Esisukiventtili

صمام العزل

schließen / ferme / close / chiudere /
cerrar / shtien / lukke / fechar /
zamykat' / zavít / uzavret' / 关 /
закрыть / bezárás / sulkeminen /
stänga / uždaryti / Zshvanen /
kapatmak / închide / κλειστό / zapretí /
sulgege / aizvērt / zavori / lukke /
zastvarne / mbylle / علق

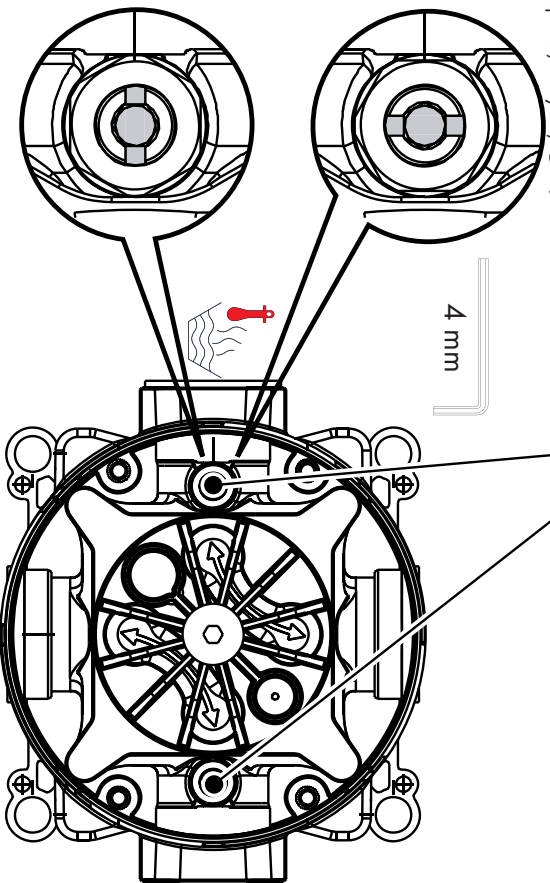

4 mm

öffnen / ouvert / open / aperto / abierto / open / åbne /
dbit / otkryt' / otevít / otvorit' / 开 / otкрыt / nyitás /
avamminen / öppna / atidaryti / Otvoranje / açmak /
deschide / avakto / odgreti / avage / divért /
otvoriti / åpne / отварање / høre / فتح

Rohmontage

Der rotationsymmetrische Grundkörper der iBox ist universell einsetzbar, horizontal wie vertikal. Ausgenommen bei der Montage der Wannennarmatur mit Sicherungskombination, hier ist nur der vertikale Einbau möglich. Da bei einem Defekt der Funktionsteile Wasser an der iBox austreten kann, muss die iBox über der Wanne montiert werden, damit austretendes Wasser in die Wanne abfließen kann!

Die iBox ist sowohl für Warmen- als auch für Brauseninstallation geeignet. Bei Einhand Wannemischer / Thermostat mit Absper- und Umstellventil ist der untere Abgang vorrangig. Bei Brauseninstallation muss der nicht benötigte Abgang mit einem Stopfen abgedichtet werden.

Große Druckunterschiede zwischen den Kalt- und Warmwasserschläüssen müssen ausgeglichen werden.

Grundkörper so einbauen, daß sich der Warmwasseranschluß links und der Kaltwasseranschluß rechts befindet. Einbautiefe 80 mm bis 108 mm.

Verlängerung 25 mm Artikelnummer 13595000

Verlängerung 22 mm (bei geringer Einbautiefe)

Artikelnummer 13593000 / 13596XXX / 13597XXX / 15597000 / 19427000 / 97407XXX / 98860000

Der Grundkörper kann entsprechend der baulichen Gegebenheiten montiert werden (Montagebeispiele siehe Seite 91 und 92).

A Installation auf die Wand.

B Installation auf die Wand. Hier mit flexiblem Abstandshalter durch 10er Stockschrauben.

C Montage auf Trägersystem.

D Installation auf Fertighaus-Montageplatten oder Fertiggelände.

E Installation direkt in die Wand.

F Installation mit Montageschlenker #92615000.

Installationsbeispiele mit Maßangaben und Leistungsdimensionierung sind ab Seite 96 zu finden. Die Erläuterung der verwendeten Symbole auf Seite 3 und 4.

Die in der Montageanleitung angegebenen Montagemaße sind ideal für Personen von ca. 1800 mm Körpergröße und müssen gegebenenfalls angepasst werden. Hierbei ist darauf zu achten, dass sich bei geänderter Montagehöhe die Mindesthöhe an der und die Änderung der Anschlussmaße berücksichtigt werden müssen.

Montage-Tipp

Um Anschlussstücke einzudrehen, die iBox mittels eines Rohrstücks in den Schraubstock einspannen.

Spülen

Komplette Installation gemäß DIN 1988 / EN 1717 spülen. Die Peile auf dem Spülblock zeigen, welcher Zulauf mit welcher Abgangseitung verbunden ist, z. B. Kaltwasser mit Abgang 1 und Warmwasser mit Abgang 2. Falls nur ein Abgang benötigt wird, muß nach dem ersten Spülvorgang der Spülblock um 90° gedreht werden.

iBox in Kombination mit einer Exafill Wanneneinlauf mit Ab- und Überlaufgarnitur (siehe Seite 95)

Technische Daten

Betriebsdruck:	max. 1 MPa
Empfohlener Betriebsdruck:	0,1 - 0,5 MPa
Prüfdruck:	1,6 MPa
(1 MPa = 10 bar = 147 PSI)	
Heißwassertemperatur:	max. 80°C
Empfohlene Heißwassertemperatur:	65°C
Anschlussmaße:	G ¾
Anschlüsse:	kalt rechts - warm links
Freier Durchfluss bei 0,3 MPa:	31 l/min // 24 l/min
Warmwasserschier:	25 l/min // 24 l/min
Wannemischer mit integrierter Sicherungskombination:	32 l/min
Brausemischer:	32 l/min
Thermostat:	43 l/min
Thermostat mit Absperventil:	26 l/min
Thermostat mit Absper- und Umstellventil:	26 l/min
Thermostat High Flow:	58 l/min
iControl:	30 l/min

Deutsch

X

Mitte Bodewanne / Mitte Duschwanne



Unterputz-Ventil

Y

Maß Y – Mitte Schlauchanschlussbogen bis Mitte Wanneneinlauf dividiert durch 2 (eventuell dem Fliesenraster anpassen).



Quattro Verwegeumstellung

Quattro

Warmwasser

Trio Universal Absperr- und Umstellventil

Kaltes Wasser



Trio

Wanneneinlauf



Ab • ist die Funktion gewährleistet.



In diesem Bereich ist eine Wandverstärkung notwendig.



Nur ein Verbraucher möglich, nicht zwei gleichzeitig.



Wasserleitungen für Seitenbrausen mit Gefälle verlegen.



Der nicht benötigte Abgang muss mit einem Blindstopfen abgedichtet werden. (DN 20 3/4"*)

Die Ablaufleistung muss mehr als 50 l/min betragen.



> 50 l/min

Ablauf



Raindrain

Spülblock kpl. #15956000, nicht im Lieferumfang enthalten



iBox in Kombination mit einer Exofill Wanneneinlauf mit Ab- und Überlaufgarnitur (siehe Seite 95)



DVGW

Wannemischer mit integrierter Sicherungskombination (siehe Seite 96)

Brausemischer (siehe Seite 104, 106, 110, 124)



Wannemischer (siehe Seite 98, 102, 114, 116)

Wanneneinlauf (siehe Seite 102)

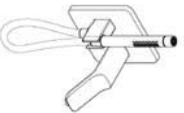

Thermostat
(siehe Seite 118, 122, 126)



High Flow Thermostat
(siehe Seite 128 - 138, 142, 144,
150 - 158)



Thermostat mit Absperrventil
(siehe Seite 104, 106, 110, 124)



Thermostat mit Absperr- und Umstell-
ventil
(siehe Seite 98, 114, 116, 120)



High Flow Thermostat mit Absperr-
ventil
(siehe Seite 140, 146, 148)

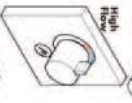

Thermostat mit Absperrventil
(siehe Seite 104, 106, 110)



Thermostat mit Absperrventil
(siehe Seite 98, 114, 116, 120)

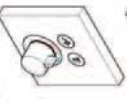

Thermostat mit Absperrventil
(siehe Seite 100, 112)



ShowerSelect Brausenischer
(siehe Seite 104, 106, 110)

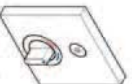

ShowerSelect Wannensischer
(siehe Seite 98, 114, 116, 120)



iControl
Absperr- und Umstellventil (siehe Seite
150)



ShowerSelect
3 x Absperrventil (siehe Seite 144,
146 - 150, 158)

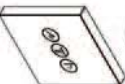

Raindance Showerpipe
(siehe Seite 108)



Raindance Rainfall 240
(siehe Seite 140, 142)



Raindance Rainfall 180
(siehe Seite 154 - 158)

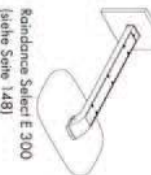

Montage de base

La pièce de base rotative symétrique de l'iBox a une possibilité de montage universel, horizontal comme vertical. Sauf pour le montage d'un mitigeur bain-douche avec disconnecteur ou si le montage vertical seulement est possible. Parceque l'eau pourrait fuir de l'iBox en cas de défaillance des pièces de fonctionnement, l'iBox doit être monté au dessus de la baignoire pour que la fuite puisse s'écouler dans la baignoire.

L'iBox est appropriée aussi bien pour les baignoires que pour les douches. Pour un mitigeur bain/douche / mitigeur thermostatique avec robinet d'arrêt et inverseur, la sortie inférieure est prioritaire. Pour une installation de douche, la sortie non utilisée doit être condamnée avec un bouchon.

Il est conseillé d'équilibrer les pressions de l'eau chaude et froide.

Monter la pièce de base pour que l'eau chaude arrive sur le côté gauche et l'eau froide sur le côté droit.

Profondeur d'encastrement: 80 mm à 108 mm.

Jeau de rallonge 25 mm référence 13595000

Rallonge de 22 mm (pour profondeur de montage trop faible)

référence 13593000 / 13596XXX / 13597XXX / 1597000 / 19427000 / 97407XXX / 988600000

La pièce de base peut être installée selon les différentes possibilités voir pages 91 et 92).

- A** Installation au mur.
- B** Installation au mur avec une vis de distance.
- C** Montage sur système support.
- D** Installation sur des panneaux de montage préfabriqués.
- E** Installation directement dans le mur.
- F** Installation avec rail de fixation #76615000.

Des exemples d'installation avec indication de cotes et dimensions des conduites sont fournis à partir de la page 96. Les symboles utilisés sont expliqués à la page 6 et 7.

Les dimensions d'installation indiquées dans la notice de montage sont idéales pour des personnes d'une taille de 1800 mm environ et doivent être ajustées selon le cas. Tenir compte pour cela du fait qu'un changement de hauteur modifie la hauteur minimum et que la modification des cotes de raccord doit entrer en ligne de compte.

Exemple de montage

Pour monter les différents raccords, on peut fixer l'iBox grâce à un tuyau et un étou.

Rinçage

Rincer l'installation complète conformément à la réglementation et aux normes. Les flèches sur le bloc de rinçage indiquent l'arrivée et la sortie qui doivent être raccordés, par exemple eau froide avec sortie 1 et eau chaude avec sortie 2. Si on utilise seulement une sortie, on devra après le premier rinçage tourner de 90° le bloc de rinçage.

iBox en combinaison avec un remplissage exafill avec mécanisme de vidage et de trop-plein (voir page 95)

Informations techniques

Pression de service autorisée:	max. 1 MPa
Pression de service conseillée:	0,1 - 0,5 MPa
Pression maximum de contrôle: (1 MPa = 10 bar = 147 PSI)	1,6 MPa
Température d'eau chaude:	max. 80°C
Température recommandée:	65°C
Dimension d'arrivée:	G¾
Raccordement:	froide à droite - chaude à gauche
Débit libre à 0,3 MPa:	31 l/min // 24 l/min
Mitigeur bains-douches:	
Mitigeur bains-douches avec disconnecteur:	25 l/min // 24 l/min

Mitigeur douche: 32 l/min

Mitigeur thermostatique: 43 l/min

Mitigeur thermostatique avec robinet d'arrêt: 26 l/min

Mitigeur thermostatique avec robinet d'arrêt et inverseur:

26 l/min

Mitigeur thermostatique High Flow: 58 l/min

Contrôle: 30 l/min

X Centre de la baignoire / Centre cuvette de douche



Robinet d'arrêt encastré

Y Dimension Y = du centre raccord coude de douche au centre bec déverseur divisé par 2 (éventuellement s'adapter au carrelage).



Quattro Inverseur quatre voies

Eau chaude



Trio Robinet d'arrêt avec inverseur

Eau froide



A partir de • le fonctionnement est garanti.



Bec déverseur



Le mur n'a pas besoin d'être renforcé à cet endroit



La sortie non utilisée doit être condamnée avec un bouchon lation. (DN 20 3/4")



Une seule utilisation possible, pas les deux ensemble.



Le débit de vidage doit être supérieur à 50 l/min.



La tuyauterie des douchettes latérales à installer avec une pente.



Vidage



bloc d'essai # 159,56000, ne fait pas partie de la fourniture



Raintrain

Box en combinaison avec un remplissage exaillil avec mécanisme de vidage et de trop plein (voir page 95)

DVGW



Mitigeur bains-douches avec disjoncteur (voir pages 96)



Mitigeur douche (voir pages 104, 106, 110, 124)



Mitigeur bains-douches (voir pages 98, 102, 114, 116)

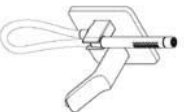

Bec déverseur (voir pages 102)

Mitigeur thermostatique
(voir pages 118, 122, 126)



High Flow Mitigeur thermostatique
(voir pages 128 - 138, 142, 144,
150 - 158)



Mitigeur thermostatique avec robinet
d'arrêt
(voir pages 104, 106, 110, 124)



Mitigeur thermostatique avec robinet
d'arrêt et inverseur
(voir pages 98, 114, 116, 120)



High Flow Mitigeur thermostatique
avec robinet d'arrêt
(voir pages 140, 146, 148)

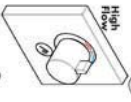

Mitigeur thermostatique avec robinet
d'arrêt
(voir pages 104, 106, 110)

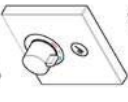

Mitigeur thermostatique avec robinet
d'arrêt
(voir pages 98, 114, 116, 120)

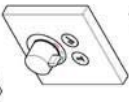

Mitigeur thermostatique avec robinet
d'arrêt
(voir pages 100, 112)



Shower>Select Mitigeur douche
(voir pages 104, 106, 110)

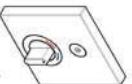

Shower>Select Mitigeur bains-douchas
(voir pages 98, 114, 116, 120)

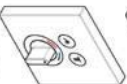

iControl
Robinet d'arrêt et inverseur (voir pages
150)

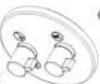

Shower>Select
3 x robinet d'arrêt (voir pages 144,
146 - 150, 158)

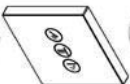

Raindance Showerpipe
(voir pages 108)



Raindance Rainfall 240
(voir pages 140, 142)



Raindance Rainfall 180
(voir pages 154 - 158)



Raindance Select E 300
(voir pages 148)

Raindance E 420
(voir pages 150, 152)



Concealed installation

The rotation symmetrical body is horizontal and vertical usable. Only exception installing the bath-shower mixer with integrated safety combination. In this case only a vertically installation is possible. Install the iBox always above the bath-tub. If parts of the iBox will broken, the water can flow in there!

The iBox is suitable for both bath and shower applications. When using the bath-shower mixer / thermostatic mixer with shut off and diverter unit outlet, the lower outlet must have priority. For shower applications, plug the unused outlet with a plug.

The hot and cold supplies must be of equal pressures. Install body with the hot water supply left and cold water supply right.

Depth of fitting: 80 mm to 108 mm.

extension 25 mm article number 13595000

Extension Set 22 mm (when wall is not deep enough).

article number 13593000 / 13596XXX / 13597XXX / 15597000 / 19427000 / 97407XXX / 98860000

The iBox can depending on the building application be mounted in different ways. Installation examples please see page 91 and 92.

- A** Direct wall installation.
- B** Direct wall installation with 10 mm adjustable mounting studs.
- C** Installation on carrier system.
- D** Hollow wall installation.
- E** Brick wall installation.
- F** Installation with fixation set #96615000.

Installation examples with measurements and pipe dimensions can be found starting on page 96. The used symbols are explained on pages 9 and 10.

The installation dimensions stated in these installation instructions are ideal for people of approximately 1800 mm in body height. The dimensions can be altered if required. In this case, pay attention to the fact that a change of installation height will also change the minimum height, and that the altered mounting dimensions must be taken into consideration.

Installation tip

To install the supply pipes, fix the iBox with a pipe in a vice.

Flush piping system

To complete the installation flush out both hot and cold water supply. The arrows on the flush body are showing, which inlet is connected with which outlet, for example cold water supply with outlet 1 and hot water supply with outlet 2. If only one outlet is in use, after first flushing the flush body must turned about 90°.

iBox in combination with an Exafill bath filler with overflow and waste (see page 95)

Technical Data

Operating pressure:	max. 1 MPa
Recommended operating pressure:	0,1 - 0,5 MPa
Test pressure:	1,6 MPa
(1 MPa = 10 bar = 147 PSI)	
Hot water temperature:	max. 80°C
Recommended hot water temp.:	65°C
Centre distance:	G ¾
Connections:	cold right - hot left
Rate of flow by 0,3 MPa:	31 l/min // 24 l/min
Bath-shower mixer:	25 l/min // 24 l/min
Bath-shower mixer with integrated safety combination:	
Shower mixer:	32 l/min
Thermostatic mixer:	43 l/min
Thermostatic mixer with shut off unit:	26 l/min
Thermostatic mixer with shut off and diverter unit:	26 l/min
Thermostatic mixer High Flow:	58 l/min
iControl:	30 l/min

X

Center bath tub / Center shower tub



Shut off valve

Y

Dimension Y = center of hose wall outlet elbow to centre of bath filler divided by 2 (match to tile layout if applicable).



Quattro 4-Way Diverter Valve

Warm water

Cold water



Quattro

Trio 2-Way Diverter Valve with integrated Shut-off valve



Trio

Bath Spout



Plug the unused outlet. [DN 20 3/4"]



The wall must be reinforced in this area.



Only one function is possible.



Install water pipes for body showers with a gradient.



The waste drain performance must be more than 50 l/min.



Waste



Rainrain



Box in combination with an Exofill bath filler with overflow and waste [see page 95]



flushing unit complete #15956000, order as on extra

DVGW

Both-shower mixer with integrated safety combination (see page 96)



Both-shower mixer (see page 98, 102, 114, 116)

Shower mixer (see page 104, 106, 110, 124)



Bath Spout (see page 102)

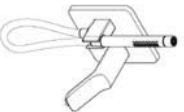



Thermostatic mixer
(see page 118, 122, 126)



High Flow Thermostatic mixer
(see page 128 - 138, 142, 144,
150 - 158)



Thermostatic mixer with shut off unit
(see page 104, 106, 110, 124)



Thermostatic mixer with shut off and
diverter unit
(see page 98, 114, 116, 120)

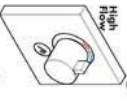

High Flow Thermostatic mixer with shut
off unit
(see page 140, 146, 148)

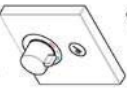

Thermostatic mixer with shut off unit
(see page 104, 106, 110)

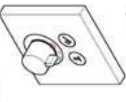

Thermostatic mixer with shut off unit
(see page 98, 114, 116, 120)



Thermostatic mixer with shut off unit
(see page 100, 112)

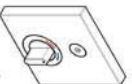

ShowerSelect Shower mixer
(see page 104, 106, 110)

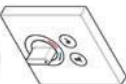

ShowerSelect Bath-shower mixer
(see page 98, 114, 116, 120)



Control
Shut off and diverter unit (see page
150)

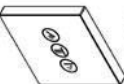

ShowerSelect
3 x stop valve (see page 144, 146 -
150, 158)

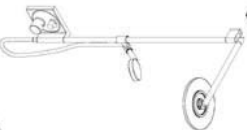

Raindance Showerpipe
(see page 108)



Raindance Rainfall 240
(see page 140, 142)



Raindance Rainfall 180
(see page 154 - 158)



Raindance E 420
(see page 150, 152)



Raindance Select E 300
(see page 148)

Installazione della tubazione

La rotazione simmetrica del corpo permette di raccordarsi agli attacchi sia verticalmente che orizzontalmente. Set vasca/doccia con valvola antiriflusso, è obbligatorio. Solo in caso di installazione del raccordarsi agli attacchi verticalmente. Installare sempre l'Box sopra alla vasca o al piatto doccia, poiché in caso di fuoriuscita d'acqua questa verrà convogliata allo scarico.

L'Box è adatto tanto ad installazioni per vasca quanto per doccia. Per i miscelatori monocomando per vasca / termostatico con rubinetto di arresto e deviatore l' uscita inferiore ha la prevalenza. Nelle installazioni per doccia l' uscita non utilizzata deve essere chiusa con un tappo. Attenzioni! Compensare le differenze di pressione tra i collegamenti dell'acqua fredda e dell'acqua calda.

Installare il corpo incasso in modo tale che il raccordo dell' acqua calda si trovi a sinistra e il raccordo dell' acqua fredda a destra.

Profondità d'installazione: da 80 mm a 108 mm.

Prolunga 25 mm codice articolo 13595000

Prolunga 22 mm x set esterno (in caso di incasso troppo esterno al muro).

codice articolo 13593000 / 13596XXX / 13597XXX / 15597000 / 19427000 / 97407XXX / 98860000

Il corpo incasso può essere installato conformemente alle condizioni edilizie, vedi esempi di installazione alle pagg. 91 e 92.

- A** Installazione a muro.
- B** Installazione a muro. Qui con la regolazione della distanza (vite nr 10).
- C** Montaggio su struttura portante.
- D** Installazione per bagni prefabbricati.
- E** Installazione diretta a muro.
- F** Installazione con pareti in cartongesso #96615000.

Esempi per l'installazione con indicazioni delle misure e per le dimensioni delle tubature sono riportati a partire dalla pagina 96. Per il significato dei simboli impiegati si vedano le pagine 12 e 13.

Le quote di montaggio indicate nelle istruzioni di montaggio sono ideali per persone grandi circa 1800 mm e eventualmente vanno adattate. A ciò bisogna fare attenzione, che ad altezza di montaggio cambiati l'altezza minima necessaria indica cambia e che bisogna considerare la modifica delle quote di collegamento.

Suggerimento per l'installazione

Per avvitare i raccordi bloccare l'Box nella morsa come illustrato.

Lavaggio della tubazione

Eeguire il lavaggio della tubazione come suggerisce la normativa DIN 1988 / EN 1717. Indicare sulla copertura del corpo quale alimentazione è collegata a quale tubo di uscita (ad es. acqua fredda con uscita 1 e acqua calda con uscita 2). Nel caso in cui si sia utilizzata una sola uscita, dopo il primo processo di lavaggio la copertura deve essere ruotata di 90° per eseguire il secondo processo di lavaggio.

l'Box in combinazione con Exafill scarico con erogazione al troppo pieno (vedi pagg. 95)

Dati tecnici

Pressione d'uso:	max. 1 MPa
Pressione d'uso consigliata:	0,1 - 0,5 MPa
Pressione di prova:	1,6 MPa
(1 MPa = 10 bar = 147 PSI)	
Temperatura dell'acqua calda:	max. 80°C
Temp. dell'acqua calda consigliata:	65°C
Distanza di raccordo:	G ¾
Raccordi:	fredda a destra - calda a sinistra
Portata a 0,3 MPa:	
Miscelatore vasca/doccia:	31 l/min // 24 l/min
Miscelatore vasca incasso con sicurezza (valv. antiriflusso):	

25 l/min // 24 l/min

Miscelatore doccia:

32 l/min

Termostatico:

43 l/min

Termostatico con rubinetto di arresto:

26 l/min

Termostatico con rubinetto di arresto e deviatore: 26 l/min

Termostatico High Flow:

58 l/min

i/Controll:

30 l/min

X

Centro vasca / Centro piatto doccia



Rubinetto di arresto

Y

Valore Y = Dal centro del raccordo a muro al centro della bocca di erogazione vasca diviso 2 (eventualmente adattare alla dimensione delle piastrelle).



Quattro Valvola a quattro vie

Acqua calda

Trio arresto/deviatore

Acqua fredda



Dal • si garantisce la funzionalità.

Bocca di erogazione



In questa zona è necessario un rinforzo della parete.

Chiudere con un tappo l'uscita non utilizzata. [DN 20 3/4"]

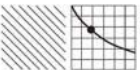

Non è possibile utilizzare due utenze in contemporanea.

La portata di scarico deve essere superiore a 50 l/min.



Posizionare i tubi alle doccette laterali con una leggera pendenza.



Scarico

Raindrain



iBox in combinazione con Exafill scarico con erogazione di troppo pieno (vedi pagg. 95)



piacca frontale # 159256000, non contenuto nel volume di fornitura

DVGW

Miscelatore vasca incasso con sicurezza (valv. antiriflusso) (vedi pagg. 96)



Miscelatore doccia (vedi pagg. 104, 106, 110, 124)

Miscelatore vasca/doccia (vedi pagg. 98, 102, 114, 116)

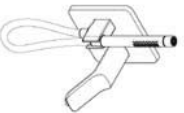

Bocca di erogazione (vedi pagg. 102)



Termostatico
(vedi pagg. 118, 122, 126)



High Flow Termostatico
(vedi pagg. 128 - 138, 142, 144, 150 - 158)



Termostatico con rubinetto di arresto
(vedi pagg. 104, 106, 110, 124)



Termostatico con rubinetto di arresto e deviatore
(vedi pagg. 98, 114, 116, 120)

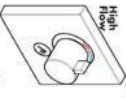

High Flow Termostatico con rubinetto di arresto
(vedi pagg. 140, 146, 148)



Termostatico con rubinetto di arresto
(vedi pagg. 104, 106, 110)



Termostatico con rubinetto di arresto
(vedi pagg. 98, 114, 116, 120)



Termostatico con rubinetto di arresto
(vedi pagg. 100, 112)

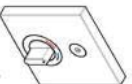

ShowerSelect Miscelatore doccia
(vedi pagg. 104, 106, 110)

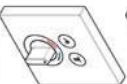

ShowerSelect Miscelatore vasca/
doccia
(vedi pagg. 98, 114, 116, 120)

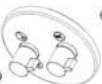

iControl
Rubinetto di arresto e deviatore (vedi
pagg. 150)

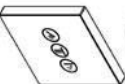

ShowerSelect
3 x rubinetto d'arresto (vedi pagg.
144, 146 - 150, 158)

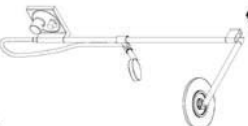

Raindance Showerpipe
(vedi pagg. 108)



Raindance Rainfall 240
(vedi pagg. 140, 142)



Raindance Rainfall 180
(vedi pagg. 154 - 158)



Raindance E 420
(vedi pagg. 150, 152)



Raindance Select E 300
(vedi pagg. 148)

Montaje del cuerpo empotrado

El cuerpo base del iBox universal se puede montar en plano horizontal y vertical. La única excepción se da al instalar el mezclador de baño/ducha con combinación de seguridad integrada. En tal caso, solo la instalación vertical es posible. Instalar el iBox siempre por encima de la bañera ya que, si se rompiera alguna pieza del iBox, el agua estaría contenida.

El iBox universal puede ser utilizado para una grifería baño/ducha o ducha. En combinación con una instalación de baño/ducha / termostato con llave de paso y distribuidor tiene prioridad la salida inferior. En combinación con un monomando ducha debe taparse la salida que no se utiliza.

Grandes diferencias de presión en servicio entre agua frío y agua caliente deben equilibrarse.

Montar el cuerpo de tal manera que el agua caliente esté a la izquierda y el agua frío esté en la derecha.

Profundidad de montaje 80 mm a 108 mm.

Prolongación 25 mm artículo número 13595000

Alargo 22 mm (en caso de pared delgada)

artículo número 13593000 / 13596XXX / 13597XXX / 15597000 / 19427000 / 97407XXX / 98860000

El cuerpo empotrado puede ser colocado según los ejemplos expuestos en las páginas 91 y 92.

A Instalación directamente sobre la pared.

B Instalación sobre la pared. Aquí con soportes de distanciamiento y tornillos de acero de 10.

C Montaje en el sistema portante.

D Instalación en placas murales prefabricados.

E Instalación directa en la pared.

F Instalación con set de guías de fijación #96615000.

A partir de la página 96 puede consultar ejemplos de instalación y dimensionamiento de la conducción. La aclaración de los símbolos utilizados en las páginas 15 y 16.

Las medidas indicadas en las instrucciones de montaje resultan ideales para personas de 1800 mm de altura, por lo que deberán ajustarse siempre que sea necesario. En este sentido, es importante tener en cuenta que, en caso de modificación de la altura de montaje, cambia la altura mínima y habrá que adaptar las medidas de conexión.

Recomendación

Para entrosacar los codos de conexión, fijar el iBox universal mediante un trozo de tubería en un tornillo de banco.

Purga de la tubería

Purgar la instalación según la normativa DIN 1988/ EN 1717. Las flechas en el bloque de purgar indican qué entrada está conectada con qué salida. Si solamente utilizará una salida se ha de girar el bloque de purgar en 90° después del primer proceso de purgar.

iBox universal en combinación con Exafill, vaciador automático con chorro incorporado y rebosadero (ver página 95)

Datos técnicos

Presión en servicio:	max. 1 MPa
Presión recomendada en servicio:	0,1 - 0,5 MPa
Presión de prueba:	1,6 MPa
(1 MPa = 10 bar = 147 PSI)	
Temperatura del agua caliente:	max. 80 °C
Temp. recomendada del agua caliente:	65 °C
Racores excéntricos:	G ¾
Racores excéntricos:	o la derecha frío - o la izquierda caliente

Caudal con 0,3 MPa	
Monomando baño/ducha:	31 l/min // 24 l/min
Monomando baño ducha con válvula anti-retorno:	25 l/min // 24 l/min
Monomando ducha:	32 l/min
Termostato:	43 l/min
Termostato con llave de paso:	26 l/min
Termostato con llave de paso y distribuidor:	26 l/min
Termostato High Flow:	58 l/min
iControl:	30 l/min

X Centro de la bañera / Centro la plato de ducha



Llave de paso

Y Medida Y – Desde el centro del racor de empalme hasta el centro de la boca de entrada a la bañera dividido por 2 (si fuera necesario, adaptar a la trama de los azulejos).



Cuatro válvula de 4 vías

Agua caliente

Trio llave de paso y distribuidor

Agua fría



Mínimo • para el correcto funcionamiento.

Caño de bañera



En este sector es necesario un refuerzo del muro.



La salida que no se utiliza debe ser tapada. (DN 20 3/4")



Solo una función posible, no dos funciones al mismo tiempo.



El caudal de deslague debe ser como mínimo de 50 l/min



Tubería hacia las duchas laterales con pendiente.



Desagüe



Carcasa para purgar #15956000, no incluido en el suministro



Raindrain



¡Box universal en combinación con Exofill, vaciador automático con chorro incorporado y rebosadero (ver página 95)

DVGW



Monomando baño ducha con válvula anti-retorno (ver página 96)



Monomando ducha (ver página 104, 106, 110, 124)



Monomando baño/ducha (ver página 98, 102, 114, 116)

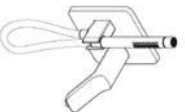

Caño de bañera (ver página 102)



Termostato
(ver página 118, 122, 126)



High Flow Termostato
(ver página 128 - 138, 142, 144,
150 - 158)



Termostato con llave de paso
(ver página 104, 106, 110, 124)



Termostato con llave de paso y
distribuidor
(ver página 98, 114, 116, 120)

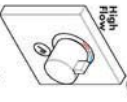

High Flow Termostato con llave de
paso
(ver página 140, 146, 148)



Termostato con llave de paso
(ver página 104, 106, 110)



Termostato con llave de paso
(ver página 98, 114, 116, 120)



Termostato con llave de paso
(ver página 100, 112)

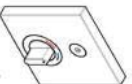

ShowerSelect Monomando ducha
(ver página 104, 106, 110)

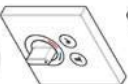

ShowerSelect Monomando baño/
ducha
(ver página 98, 114, 116, 120)



iControl
Llave de paso y distribuidor (ver
página 150)

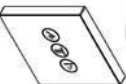

ShowerSelect
3 x Llave de paso (ver página 144,
146 - 150, 158)

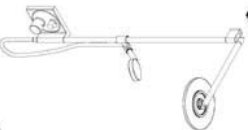

Raindance Showerpipe
(ver página 108)



Raindance Rainfall 240
(ver página 140, 142)



Raindance Rainfall 180
(ver página 154 - 158)



Raindance E 420
(ver página 150, 152)



Raindance Select E 300
(ver página 148)

Ruwbouw

Het symmetrische basisgarnituur iBox universeel is zowel horizontaal als verticaal toe te passen. Uitgezonderd bij montage van een badmengkraan met zekerheidscombinatie, deze kan alleen verticaal worden ingebouwd. Bij een defect onderdeel kan mogelijkerwijs water uit de iBox weglagen. Daarom moet de iBox boven het bad gemonteerd worden. Het lekwater wordt dan in het bad afgevoerd!

De iBox is zowel geschikt voor installatie bij het bad als bij de douche. Bij de ééngreeps badmengkraan / thermostaat met stop- en omstelkraan heeft de onderste uitgang voorrang. Bij installatie in de douche moet de onbenodigde uitgang met een blindstop worden afgedicht.

Grote drukverschillen tussen de koud- en warmwatertoevoer dienen vermeden te worden.

Basisgarnituur zo inbouwen, dat de aansluiting voor warm water links en voor koud water rechts zit.

Inbouwdiepte 80 mm tot 108 mm.

Verlengstuk 25 mm Artikelnummer 13595000

verlengset 22 mm (bij geringe inbouwdiepte)

Artikelnummer 13593000 / 13596XXX / 13597XXX / 15597000 / 19427000 / 97407XXX / 98860000

Het basisgarnituur kan overeenkomstig de situatie ter plaatse worden ingebouwd. Montagevoorbeelden zie pag. 91 en 92.

- A** Installatie voor de wand.
- B** Installatie voor de wand.
- C** Montage op houdersysteem.
- D** Installatie in pletob systemen.
- E** Installatie in de wand.
- F** Installatie met montageset #96615000.

Installatievoorbeelden met massagegevens en capaciteitsdimensionering staan op pagina 96. De toelichting bij de gebruikte symbolen op pagina 18 en 19.

De in de handleiding aangegeven montagematen richten zich op personen van ca. 1800 mm groot en moeten indien nodig aangepast worden. Daarbij moet in acht genomen worden dat bij een gewijzigde montagehoogte ook de minimumhoogte verandert en dat de aansluitmaten overeenkomstig moeten worden aangepast.

Montage tip

Om aansluitingen in te draaien de iBox door middel van een koppeling in de bank Schroef vastzetten.

Spoelen

De complete installatie overeenkomstig DIN 1988/ EN 1717 spoelen. De pinnen op het speelblok geven aan welke ingang met welke uitgang verbonden is, bijv. koud water met uitgang 1 en warm water met uitgang 2. Wanneer slechts 1 uitgang wordt gebruikt, moet men na de eerste spoeling het speelblok 90° draaien.

iBox in combinatie met Exafill badvul-, afvoer- en overloopgarnituur (zie blz. 95)

Technische gegevens

Werkdruk: max.	max. 1 MPa
Aanbevolen werkdruk:	0,1 - 0,5 MPa
Gelast bij:	1,6 MPa
(1 MPa = 10 bar = 147 PSI)	
Temperatuur warm water:	max. 80°C
Aanbevolen warm water temp.:	65°C
Aansluitmaten:	G ¾
Aansluitingen:	koud rechts - warm links
Vrije doorstroom bij 0,3 MPa:	31 l/min // 24 l/min
Badmengkraan:	31 l/min // 24 l/min
Badmengkraan met geïntegreerde zekerheidscombinatie:	25 l/min // 24 l/min
Douchemengkraan:	32 l/min
Thermostaat:	43 l/min
Thermostaat met stopkraan:	26 l/min
Thermostaat met stop- en omstelkraan:	26 l/min
Thermostaat High Flow:	58 l/min
Control:	30 l/min

X

Midden bod / Midden Douchebak



Inbouwstopkraan

Y

Maat Y – afstand tussen muuraansluitbochi en boduitloop hart op hart, gedeeld door 2 (eventueel rekening houden met de wandtegels).



Quattro 4-weg omstelkraan

Quattro

Warm water

Trio stop- en omstelkraan

Koud water



Trio



Vanaf • is het functioneren gegarandeerd.

Boduitloop



In dit bereik is een wandversterking noodzakelijk.

De niet benodigde uitgang moet met een blindstop worden afgedicht. (DN 20 3/4")



Slechts 1 functie mogelijk: geen 2 functies tegelijkertijd.



De afvoer capaciteit moet meer dan 50 l/min bedragen.



Waterleidingen voor zijdouches aflopend plaatsen.



Raindrain

spoelblok kompl. # 15926000, behoort niet tot het leveringspakket



Exofill

iBox in combinatie met Exofill bodvul-, afvoer- en overloopgarntuur (zie blz. 95)

DVGW

Bodemengkraan met geïntegreerde zekerheidscombinatie (zie blz. 96)



Douchemengkraan (zie blz. 104, 106, 110, 124)

Bodemengkraan (zie blz. 98, 102, 114, 116)



Boduitloop (zie blz. 102)

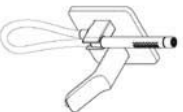

Thermostaat
(zie blz. 118, 122, 126)



High Flow Thermostaat
(zie blz. 128 - 138, 142, 144, 150 - 158)



Thermostaat met stopkraan
(zie blz. 104, 106, 110, 124)



Thermostaat met stop- en omselkroan
(zie blz. 98, 114, 116, 120)



High Flow Thermostaat met stopkraan
(zie blz. 140, 146, 148)

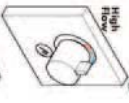

Thermostaat met stopkraan
(zie blz. 104, 106, 110)

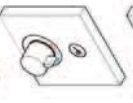

Thermostaat met stopkraan
(zie blz. 98, 114, 116, 120)

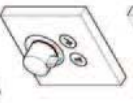

Thermostaat met stopkraan
(zie blz. 100, 112)



ShowerSelect Douchemengkraan
(zie blz. 104, 106, 110)

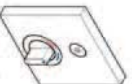

ShowerSelect Bodmenigkraan
(zie blz. 98, 114, 116, 120)



iControl
Stop- en omselkroan (zie blz. 150)



ShowerSelect
3 x inbouwstopkranen (zie blz. 144, 146 - 150, 158)

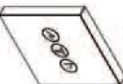

Raindance Showerpipe
(zie blz. 108)



Raindance Rainfall 240
(zie blz. 140, 142)



Raindance Rainfall 180
(zie blz. 154 - 158)



Raindance E 420
(zie blz. 150, 152)



Raindance Select E 300
(zie blz. 148)

Råmontage

Iboxens grundrop er universel – kan monteres horisontalt og vertikalt. Undtagelsen er dog ved montering af kar/brusearmaturer med integreret sikkerhedskombination, her er kun den vertikale montering mulig. Da der ved øvt defekt vil komme vand i iboxen, skal denne monteres over karret, således at vandet ledes ned i karret!

Iboxen er egnet til såvel kar- som til bruseinstallation. Ved 1-grebs kararmatur / termostat med afspæringsventil og omskifter er afgang foruden primæragang. Ved bruseinstallation skal den overfløede afgang afproppes.

Større trykforstælle mellem koldt og varmt vand bør udlæsvæs.

Grundkroppen indbygges således, at varmtvandslslutningen er til venstre og koldtvarndslslutningen er til højre.

Monteringsdybde 80 mm til 108 mm.

Forlængersæt 25 mm art. nr. 13595000

Forlænger 22 mm (ved for stor indbygningdybde)

art. nr. 13593000 / 13596XXX / 13597XXX / 1597000 / 19427000 / 97407XXX / 98860000

For monteringseksempler se s. 91 og 92.

- A** Installation på væggen.
- B** Installation på væggen. Her med fleksibel afstandsholder med 10 mm justerbar monteringskrave.
- C** Montering på skinesystemet.
- D** Installation på montageplade.
- E** Installation direkte i væggen.
- F** Installation med monterings-skinesæt #92615000.

Installationseksempler med mål og ledningsdimensioner kan efterlæses fra side 96. Forklaringer til symbolerne findes på side 21 og 22.

Målene i monteringsanvisningen er ideel til personer med en størrelse på 1800 mm og skal i givet fald tilpasses. Herved skal der tages hensyn til, at den mindste højde i tilfælde af en ændret monteringshøjde ændres og at der skal tages hensyn til de ændrede tilslutningsmål.

Monterings-tips

For montering af tilslutningsvinkler, kan Iboxen fastspændes i en skruetvinge ved hjælp af et rørstyrkke.

Gennemskylning

Den komplette installation skal gennemskyldes efter DIN 1988 / EN 1717. Pløene på tegningen viser, hvilke tilgange og oflgange der er forbundet med hinanden, f.eks. koldt/vand med afgang 1 og varmt/vand med afgang 2. I tilfælde hvor kun én afgang benyttes, skal skylleblokken drejes 90° efter første gennemskylning.

IBox i kombination med Exafill påfyldnings- og overløbsgarniture (se s. 95)

Tekniske data

Drifttryk:	max. 1 MPa
Anbøtlet drifttryk:	0,1 - 0,5 MPa
Prøvetryk:	1,6 MPa
(1 MPa = 10 bar = 147 PSI)	
Varmtvandstemperatur:	max. 80°C
Anbøtlet varmtvandstemperatur:	65°C
Tilslutningsmål:	G ¾
Tilslutninger:	Koldt højre - varmt venstre
Fri gennemstrømning ved 0,3 MPa:	31 l/min // 24 l/min
Kararmatur med integreret sikkerhedskombination::	25 l/min // 24 l/min
Brusearmaturer:	32 l/min
Termostat:	43 l/min
Termostat med afspæringsventil:	26 l/min
Termostat med afspæringsventil og omskifter:	26 l/min
Termostat High Flow:	58 l/min
i/Control:	30 l/min

X

Midt badekar / Midt brusekar



Alspæringsventil

Y

Mål Y = Midt slangeudgang til midt kartud divideret med 2 (evt. tilpas med fuger i fliserne).



Quattro 4-vejs ventil



Varmt vand

Trio dbspæringsventil og omskifter

Koldt vand



Trio

Fra • er funktionen anvendelig.

Kartud



I dette område er en forstærkning af væggen nødvendig!

Alngangen, der ikke benyttes, skal afpropes. (DN 20 ¾")



Det er kun muligt at benytte én funktion ad gangen.

Allebskopocleten skal være mere end 50 l/min.



> 50 l/min

Alløb



Vandledningerne til sidebruserne med fold.



Rainrain

iBox i kombination med Exafill pøtylednings- og overløbsgarniture (se s. 95)



Exafill

DVGW

Kararnatur med integreret sikkerhedskombination, (se s. 96)



Brusearmaturer (se s. 104, 106, 110, 124)

Kararnaturer (se s. 98, 102, 114, 116)



Kartud (se s. 102)

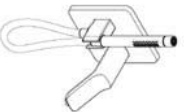



Termostat
(se s. 118, 122, 126)



High Flow Termostat
(se s. 128 - 138, 142, 144, 150-158)



Termostat med afspæringsventil
(se s. 104, 106, 110, 124)



Termostat med afspæringsventil og omskifter
(se s. 98, 114, 116, 120)

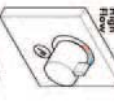

High Flow Termostat med afspæringsventil
(se s. 140, 146, 148)

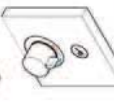

Termostat med afspæringsventil
(se s. 104, 106, 110)

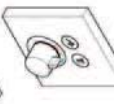

Termostat med afspæringsventil
(se s. 98, 114, 116, 120)



Termostat med afspæringsventil
(se s. 100, 112)

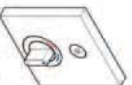

ShowerSelect Brusearranger
(se s. 104, 106, 110)

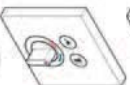

ShowerSelect Karamander
(se s. 98, 114, 116, 120)



Kontrol
Afspæringsventil og omskifter (se s. 150)

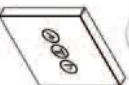

ShowerSelect
3 x Afspæringsventil (se s. 144, 146-150, 158)



Raindance Showerpipe
(se s. 108)



Raindance Rainfall 240
(se s. 140, 142)



Raindance Rainfall 180
(se s. 154 - 158)



Raindance E 420
(se s. 150, 152)

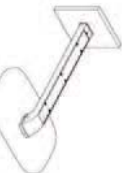

Raindance Select E 300
(se s. 148)

Instalação embutida na parede

O corpo de rotação simétrica pode ser instalado quer na horizontal quer na vertical. A única exceção é ao instalar uma misturadora de banheira/chuveiro com combinação de segurança. Neste caso, apenas é possível uma instalação vertical. Instalar a iBox sempre sobre a banheira. No caso de haver algum defeito nas peças da iBox a água pode fluir para lá.

A iBox é aplicável numa instalação de banheira e de chuveiro. Na misturadora de monobloco para banheira / misturadora termostática com inversor/válvula de corte, a saída inferior é prioritária. Na instalação num chuveiro é necessário vedar a saída desnecessário com um tapão.

Grandes diferenças entre as pressões das águas quente e fria devem ser compensadas.

Instalar o corpo com a ligação para água quente à esquerda e a ligação para a água fria à direita.

Profundidade de montagem 80 mm até 108 mm.

Crescente 25 mm referência 13595000

Crescente 22 mm (quando instalado demonstrado longe da parede)

referência 13593000 / 13596000 / 13597000 / 15597000 / 19427000 / 97407000 / 98860000

O corpo pode, dependendo da construção, ser instalado de diferentes maneiras, ver nas páginas 91 e 92 exemplos de instalação

A Instalação sobre a parede.

B Instalação sobre a parede com colçoo ajustáveis de 10 mm.

C Montagem no sistema de suporte.

D Instalação em paredes ocas.

E Instalação em paredes de tijolo.

F Instalação com sel de fixação #96615000.

Exemplos de instalação com indicações dimensionais e dimensionamento das tubagens, podem ser encontrados a partir da página 96. A explicação dos símbolos empregues, encontra-se na página 24 e 25.

As dimensões de montagem indicadas nas instruções de montagem são ideais para passaros com uma altura aprox. 1800 mm e têm que ser eventualmente adaptadas. Neste contexto deve ter-se em atenção que alterações na altura de montagem obrigam a alterações na altura mínima, bem como alterações nas dimensões de ligação.

Conselho para montagem

Para instalar as curvas de ligação na iBox coloque um tubo na iBox e prendo-o num torno.

Purgar as tubagens

Para completar a instalação purgar as tubagens de água quente e da água fria. As setas no corpo de descarga estão a mostrar que entrada está ligada com que saída, por exemplo, água fria com saída 1 e água quente com saída 2. Se apenas estiver em uso uma saída, após a 1ª purgagem o corpo de descarga deve ser rodado cerca de 90°.

iBox em combinação com Exafill com bica e avisador (ver página (ver página 95)

Dados Técnicos

Pressão de funcionamento:	max. 1 MPa
Pressão de func. recomendada:	0,1 - 0,5 MPa
Pressão testado:	1,6 MPa
(1 MPa = 10 bar = 147 PSI)	
Temperatura da água quente:	max. 80 °C
Temp. água quente recomendado:	65 °C
Distância entre eixos:	G ¾
Ligações:	frio à direita - quente à esquerda
Caudal a 0,3 MPa:	
Misturadora de banheira/chuveiro:31 l/min //	24 l/min
Misturadora de banheira/duche com combinação de segurança integrada:	

Misturadora de chuveiro:	25 l/min //	24 l/min
Misturadora termostática:	32 l/min	
Misturadora termostática:	43 l/min	
Misturadora termostática com válvula de corte:26 l/min		
Misturadora termostática com inversor/válvula de corte:		
26 l/min		
Misturadora termostática High Flow:	58 l/min	
iControl:	30 l/min	

X

Meio da banheira / Meio do boste de duche



Torneira de passagem

Y

Medida Y=Centro da curva de ligação até ao centro da bica da banheira dividida por 2 (conjugar com os azulejos, se for o caso).



Quatro válvula de diverção de 4 vias

Água quente

Trio universal inversor/válvula de corte

Água fria



Trio



• A partir deste ponto inicia-se o funcionamento correcto.



Entrada de banheira



Nesta zona é necessário um reforço na parede.

Tamponar a saída não utilizada. (DN 20 3/4")



Apenas uma saída de cada vez, não duas simultaneamente.

Capacidade de escoamento tem que ser superior a 50 l/min.



Instalar os tubos para os chuveiros laterais com ligeira inclinação.



Escoamento



Raindrain

Corpo de descarga compl. #15956000, não incluído no volume de fornecimento

!Box em combinação com Exafill com bico e visador (ver página (ver página 95)



Exafill

DVGW



Misturadora de banheira/duche com combinação de segurança integrada (ver página 96)



Misturadora de chuveiro (ver página 104, 106, 110, 124)



Misturadora de banheira/chuveiro (ver página 98, 102, 114, 116)

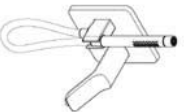

Entrada de banheira (ver página 102)



Misturadora termostática
(ver página 118, 122, 126)



High Flow Misturadora termostática
(ver página 128 - 138, 142, 144,
150 - 158)



Misturadora termostática com válvula
de corte
(ver página 104, 106, 110, 124)



Misturadora termostática com inver-
sor/válvula de corte
(ver página 98, 114, 116, 120)

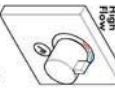

High Flow Misturadora termostática
com válvula de corte
(ver página 140, 146, 148)

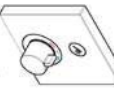

Misturadora termostática com válvula
de corte
(ver página 104, 106, 110)

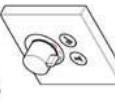

Misturadora termostática com válvula
de corte
(ver página 98, 114, 116, 120)

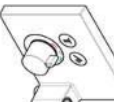

Misturadora termostática com válvula
de corte
(ver página 100, 112)

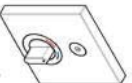

ShowerSelect Misturadora de
chuveiro
(ver página 104, 106, 110)

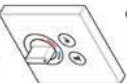

ShowerSelect Misturadora de banhei-
ro/chuveiro
(ver página 98, 114, 116, 120)



iControl
Inversor / válvula de corte (ver página
150)

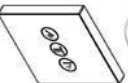

ShowerSelect
3 x Válvula de corte (ver página 144,
146 - 150, 158)

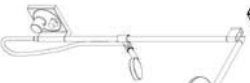

Raindance Showerpipe
(ver página 108)



Raindance Rainfall 240
(ver página 140, 142)



Raindance Rainfall 180
(ver página 154 - 158)



Raindance E 420
(ver página 150, 152)



Raindance Select E 300
(ver página 148)

Montaż przyłączy

Uniwersalny okrągły kształt korpusu iBox pozwala na dowolny sposób montażu i zabudowy, zarówno pionowy jak i poziomy. Z wyjątkiem montażu armatury wannowej ze zintegrowanym systemem zabezpieczającym do wylewki, możliwy jest tylko montaż pionowy. W przypadku uszkodzenia jakichkolwiek elementów przepływającej woda może kapnąć z iBoxa, dlatego też należy zamontować go nad wanną, dzięki czemu woda będzie mogła spływać do wanny.

iBox można wykorzystać zarówno jako baterię wannową jak i jako baterię natryskową. Przy jednoczesnym mieszaniu wannowym / termostat z zaworem odcinającym/przełączającym dolne wyjście ma pierwszeństwo. Przy instalacji przyszlincowej niepotrzebne wyjście musi zostać zamknięte korkiem uszczelniającym.

Znaczne różnice ciśnienia na dopływach ciepłej i zimnej wody muszą zostać wyrównane.

Korpus zabudować w taki sposób, aby przyłącza zimnej wody znajdowały się po prawej stronie, a ciepłej po lewej.

Głębokość montażu 80 - 108 mm

Przedłużka 25 mm nr art. 13595000

Rozeta maskująca 22 mm (przy mojej głębokości zabudowy)

nr art. 13593000 / 13596XXX / 13597XXX / 15597000 / 19427000 / 97407XXX / 98860000

Korpus może zostać zabudowany w różnych stadiach budowlanych, przykłady montażowe patrz str. 91 i 92.

A Instalacja na ścianie.

B Instalacja przed ścianą. Na śrubach gwintowanych M10 jako elementy dystansowe.

C Montaż na systemie stelaży.

D Instalacja gotowych płyt montażowych albo gotowych kabin.

E Instalacja w ścianie.

F Instalacja z szynami mocującymi #96615000.

Przykłady instalacji z podaniem ciężarów i rozmiarów przewodów, patrz od strony 96. Wyjaśnienie używanych symboli, patrz strona 27 i 28.

Wymiary montażowe podane w instrukcji montażowej są idealne dla osób o wzroście sięgającym ok. 1800 mm i w razie konieczności należy je dostosować. Należy przy tym zwrócić uwagę na fakt, iż przy zmniejszaniu wysokości montażu zmienia się minimalna wysokość, a także ulegają zmianie wymiary przyłączy.

Wskazówki montażowe

Aby dokręcić przyłącza, zamocować iBox w imadle.

Plukanie

Przeplukac gotową instalację zgodnie z normą. Znaczące szralki jakże doprowadzenie instalacji odpowiada kolejnemu przyłączu np. zimna woda z odpływem 1, ciepła woda z odpływem 2. W przypadku gdy wykonywane jest tylko jedno wyjście, należy obrócić po pierwszym przeplukaniu o 90° przeplukiwany blok.

iBox w kombinacji z odpływem wannowym Exafill posiadającym możliwość napełniania i opróżniania wanny (patrz strona 95)

Dane techniczne

Ciążenie robocze:	maks. 1 MPa
Zalecane ciśnienie robocze:	0,1 - 0,5 MPa
Ciążenie próbne:	1,6 MPa
(1 MPa = 10 bary = 147 PSI)	
Temperatura wody gorącej:	maks. 80 °C
Zalecana temperatura wody gorącej:	65 °C
Wymiary przyłącza:	G ¾
Przyłącza:	Zimno prawo - ciepła lewo
Swobodny przepływ przy 0,3 MPa:	31 l/min // 24 l/min
Mieszacz wannowy:	
Mieszacz wannowy ze zintegrowanym systemem zabezpieczającym do wylewki:	25 l/min // 24 l/min
Mieszacz przyszlincowy:	32 l/min
Termostat:	43 l/min
Termostat z zaworem odcinającym:	26 l/min
Termostat z zaworem odcinającym/przełączającym: 26 l/min	
Termostat High Flow:	58 l/min
iControl:	30 l/min

X Środek wanny / Środek brodzika



Zawór podłytkowy

Y

Wymiary Y – środek mocowania węzła przysznycowego do środka wylewki napełniającej wannę podzielony przez 2 (ewentualnie do posuwoc do układu płytek ceramicznych).



Regulator czterodrożny Quattro

Ciepła woda



Zawór odcinający i regulacyjny Trio

Zimna woda



Universal

Od • możliwe jest funkcjonowanie.

Wylewka wannowa



W tym obszarze konieczne jest wzmocnienie ściany.



Niewykorzystany wylot należy zakorkować dołożonym w dostawie korkiem. [DN 20 3/4]



Możliwe uruchamianie tylko każdego odbiornika osobno.



Wydatność odpływu musi być wyższa niż 50 l/min.



Przewody doprowadzające do przysznyców bocznych położyć z nachyleniem.



Raindrain

Odpływ



Blok pływający #15956000. Nie jest częścią dostawy



Exafill

iBox w kombinacji z odpływem wannowym Exafill posiadającym możliwość napełnienia i opróżnienia wanny (patrz strona 95)

DVGW



Mieszacz wannowy ze zintegrowanym systemem zabezpieczającym do wylewki (patrz strona 96)



Mieszacz przysznycowy (patrz strona 104, 110, 124)



Mieszacz wannowy (patrz strona 98, 102, 114, 116)

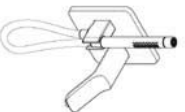

Wylewka wannowa (patrz strona 102)



Termośiat
(patrz strona 118, 122, 126)



High Flow Termośiat
(patrz strona 128 - 138, 142, 144,
150, 158)



Termośiat z zaworem odcinajqcyym
(patrz strona 104, 106, 110, 124)



Termośiat z zaworem odcinajqco-prze-
laczajqcyym
(patrz strona 98, 114, 116, 120)

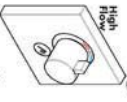

High Flow Termośiat z zaworem
odcinajqcyym
(patrz strona 140, 146, 148)

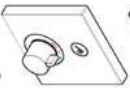

Termośiat z zaworem odcinajqcyym
(patrz strona 104, 106, 110)

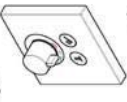

Termośiat z zaworem odcinajqcyym
(patrz strona 98, 114, 116, 120)



Termośiat z zaworem odcinajqcyym
(patrz strona 100, 112)



ShowerSelect Mieszacz Prysznicowy
(patrz strona 104, 106, 110)

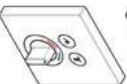

ShowerSelect Mieszacz wannowy
(patrz strona 98, 114, 116, 120)

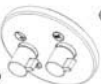

iControl
Zawór odcinajqcy i regulacyjny (patrz
strona 150)

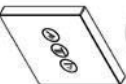

ShowerSelect
3 x Zawór odcinajqcy (patrz strona
144, 146 - 150, 158)



Raindance Showerpipe
(patrz strona 108)



Raindance Rainfall 240
(patrz strona 140, 142)



Raindance Rainfall 180
(patrz strona 154 -
158)



Raindance E 420
(patrz strona 150, 152)



Raindance Select E 300
(patrz strona 148)

Hrubá montáž

Rotačně symetrické základní těleso iBox je univerzálně použitelné, horizontálně i jakož i vertikálně. Nepřítí pro montáž vanové armatury s bezpečnostní kombinací, zde je možná pouze vertikální montáž. Protože v případě závodny funkčních dílů může začít z jednotky iBox vytékat voda, musí být iBox instalován nad vanou, která vytékající vodu odvede.

iBox je vhodný jak pro vanovou, tak i pro sprchovou instalaci. U vanové / termostat s uzavíracím a přeplínacím ventilem jednoruční pákové batérie je prioritní spodní vývod. U sprchové instalace musí být nepoužitý vývod ušněn a zasklepovací zátkou

Je nutné vyrovnat velké rozdíly tlaku mezi přípoji studené a teplé vody.

Základní těleso zabudovat tak, aby se přípoj teplé vody nacházel vlevo a přípoj studené vody vpravo.

Hloubka zabudování 80 mm až 108 mm.

prodloužení 25 mm kat.č. 13595000

prodloužení 22 mm (př malé hloubce zabudování)

kat.č. 13593000 / 13596XXX / 13597XXX /

15597000 / 19427000 / 97407XXX / 98860000

Základní těleso může být namontováno v souladu s počátečními náznaky na stránce, příklady montáže viz strana 91 a 92.

A Instalace na stěnu.

B Instalace před stěnu. Zde s vavřablinými rozpěrkami pomocí šroubu M 10.

C Montáž na nosný systém.

D Instalace na montážní panely nebo prefabrikované burky.

E Instalace přímo do stěry.

F Instalace se sodou montážních lišt #96615000.

Příklady instalace s údaji o rozměrech a dimenzování potřebu jsou uvedeny od strany 96. Vysvětlivky k použitelným symbolům naleznete na straně 30 a 31.

Montážní rozměry uvedené v návodu pro montáž jsou ideální pro osoby s výškou postavy přibližně 1800 mm a v případě potřeby je nutné je přizpůsobit. Při tom je zapotřebí dbát nato, že se při změněné výšce montáže změni požadovaná minimální výška a že je třeba brát ohled na přípojovací rozměry.

Montážní tip

Abyste bylo možno zatáčet přípojovací hadičky do iBoxu, upněte iBox pomocí častí trubky do světlíku.

Propláchnutí

Kompletní instalaci propláchnout podle normy DIN 1988. Šipka na propláchnovacím bloku ukazuje, kterým proudem je spojen se kterým vedením vývodu, např.

studená voda s vývodem 1 a teplá voda s vývodem 2.

Jestli potřebný pouze jeden vývod, musí být po prvním vypláchnutí propláchnovací blok otočen o 90 stupňů.

iBox v kombinaci s vanovým napouštěním Exafill s odpádní a přeřadovov garniturou (viz strana 95)

Technické údaje

Provozní tlak:	max. 1 MPa
Doporučený provozní tlak:	0,1 - 0,5 MPa
Zkušební tlak:	1,6 MPa
(1 MPa = 10 bar = 147 PSI)	
Teplota horké vody:	max. 80 °C
Doporučená teplota horké vody:	65 °C
Rozteč připojení:	G ¾
Přípoje:	studená vpravo - teplá vlevo
Volný průtok při 0,3 MPa	31 l/min // 24 l/min
Vanová batérie s integrovanou bezpečnostní kombinací:	25 l/min // 24 l/min
Sprchová armatura:	32 l/min
Termostat:	43 l/min
Termostat s uzavíracím ventilem:	26 l/min
Termostat s uzavíracím a přeplínacím ventilem:	26 l/min
Termostat High Flow:	58 l/min
iControl:	30 l/min

X

Sříd sprchové vany / Sříd sprchové vany



Podomítkový uzavírací ventil

Y

Rozměr Y – vzdálenost sřídů připojení sprchové hadice od sředu vanového napouštění dělítelná 2 (eventuelně přizpůsobit rozměru obkladů).



Quattro čtyřcestné přestavování

Teplá voda

Trio Universal - Uzavírací a přepínací ventil

Studená voda



Od • je zaručená funkce

Vanový vtok



V této oblasti je potřebné zesílení stěny.



Nepoužijte vývod musí být utěsněn zaskle povodí zdíkou. (DN 20 3/4")



Je možné použít pouze jeden spotřebič, ne dva současně.

Odkokový výkon musí být vyšší než 50 l/min.



Vodovodní potrubí pro boční sprchový nainstalovat se spodem.

Odkok



výplachový blok kompl. #15956000, není součástí dodávky



Raindrain



!Box v kombinaci s vanovým napouštěním Exallil s odpadní a přepodovou garniturou (viz strana 95)

DVGW

Vanová baterie s integrovanou bezpečnostní kombinací (viz strana 96)



Sprchová armatura (viz strana 104, 106, 110, 124)

vanová baterie (viz strana 98, 102, 114, 116)

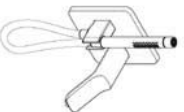

Vanový vtok (viz strana 102)

Termoštát
(viz strana 118, 122, 126)



High Flow Termoštát
(viz strana 128 - 138, 142, 144,
150 - 158)



Termoštát s uzavíracím ventillem
(viz strana 104, 106, 110, 124)



Termoštát s uzavíracím a přeplňovacím
ventilem
(viz strana 98, 114, 116, 120)



High Flow Termoštát s uzavíracím
ventilem
(viz strana 140, 146, 148)

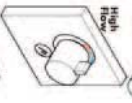

Termoštát s uzavíracím ventillem
(viz strana 104, 106, 110)



Termoštát s uzavíracím ventillem
(viz strana 98, 114, 116, 120)

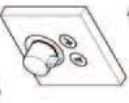

Termoštát s uzavíracím ventillem
(viz strana 100, 112)



ShowerSelect Sprchová armatura
(viz strana 104, 106, 110)

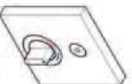

ShowerSelect vanová baterie
(viz strana 98, 114, 116, 120)

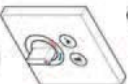

iControl
Uzavírací a přeplňovací ventil (viz strana
150)



ShowerSelect
3 x uzavírací ventil (viz strana 144,
146 - 150, 158)

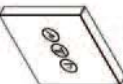

Raindance Showerpipe
(viz strana 108)



Raindance Rainfall 240
(viz strana 140, 142)



Raindance Rainfall 180
(viz strana 154 - 158)



Raindance Select E 300
(viz strana 148)

Raindance E 420
(viz strana 150, 152)

Hrubá montáž

Rotačne symetrické základné teleso iBox je univerzálne použiteľné, horizontálne aj vertikálne. Neplatí pri montáži vanové armatúry s bezpečnostnou kombináciou, zde je možné použiť vertikálnu montáž. Pretože v prípade poruchy funkčných častí môže začať z jednotky iBox vytekať voda, musí byť iBox namontovaný nad vaňou, ktorá vytekajúcu vodu odvedie.

iBox je vhodný tak pre vaňovú ako aj sprchovú inštaláciu. Pre jednotučnú pákovú vaňovú batériu / termostatická batéria s uzatváracou jednotkou a prestavovacím ventilom je prioritný spodný vývod. Pre sprchovú inštaláciu musí byť nepoužitý vývod zasklepený zátkou.

Veľké rozdiely v tlaku medzi pripojkami studenej a teplej vody musia byť vyrovnané.

Základné teleso zobudovať tak, aby prívod teplej vody bol vľavo a prívod studenej vody vpravo.

Montážna hĺbka: 80 mm až 108 mm.

Predĺženie 25 mm výrobné číslo 13595000

Predĺženie 22 mm (pri malej montážnej hĺbke).

výrobné číslo 13593000 / 13596XXX / 13597XXX / 15597000 / 19427000 / 97407XXX / 98860000

Základné teleso je montované podľa podmienok na strane podľa príkladov inštalácie vii strana 91 a 92.

A Inštalácia na stenu.

B Inštalácia pred stenu pomocou nastaviteľných 10 mm skrutiek.

C Montáž na nosný systém.

D Inštalácia na montážne dosky kotloveho domu alebo kotlove bunky.

E Inštalácia priamo do steny.

F Inštalácia so sadou montážnych lišt #96615000.

Inštalčné príklady s uvedením rozmerov a výkonov nájdete od strany 96. Vysvetlenie použitých symbolov nájdete na strane 33 a 34.

Montážne rozmery uvedené v návode na montáž sú ideálne pre osoby s výškou postavy približne 1800 mm a v prípade potreby je nutné ich prispôsobiť. Pri tom je nutné si uvedomiť, že pri zmenej výške montáže sa mení minimálna výška a je nutné dbať na rozmery rozmiestnenia prípojok.

Montážny tip

Abys sa dali pripojiť kusy dobre zatiaľ, upne sa iBox pomocou trubkovej narovky do zverátka.

Prepláchnutie

Kompletnú inštaláciu prepláchnuť podľa normy DIN 1988. Šípka na prepláchnovacom bloku ukazuje, ktorý prívod je spojený s ktorým vedením vývodu, napr. prívod studenej vody s vývodom 1, prívod teplej vody s vývodom 2. Ak je použitý len jeden vývod, musí byť prvom prepláchnuť prepláchnovací blok otočený o 90 stupňov.

iBox kombinovaný s EXAFILL vaňovým napúšťaním s odpadovou a prepádovou garnitúrou (viď strana 95)

Technické údaje

Prevádzkový tlak:	max. 1 MPa
Doporučený prevádzkový tlak:	0,1 - 0,5 MPa
Skúšobný tlak:	1,6 MPa
(1 MPa = 10 bar = 147 PSI)	
Teplota teplej vody:	max. 80°C
Doporučená teplota teplej vody:	65°C
Pripojacie rozmery:	G ¾
Pripoje:	studená vpravo - teplá vľavo
Volný prietok pri 0,3 MPa	31 l/min // 24 l/min
vaňová batéria:	
mešalna batéria za kopalno kadz v vgrajeno varovalno kombinacijo:	25 l/min // 24 l/min
Sprchová batéria:	32 l/min
Termostatická batéria:	43 l/min
Termostatická batéria s uzatváracím ventilom:	26 l/min
Termostatická batéria s uzatváracou jednotkou a prestavovacím ventilom:	26 l/min
Termostatická batéria High Flow:	58 l/min
iControl:	30 l/min

X Stred xane / Stred sprchovej vane



Podmielikový uzatvárací ventil

Y Rozmer Y – vzdialenosť stredu pripojenia sprchovej hadice od stredu vaňového napúšťania deliteľná 2 (prípadne prispôsobíť rozmeru obkladu)



Quattro štvorcové prestavenie

Teplá voda



Quattro

Studená voda



Trio

Trio univerzálny uzatvárací a prestavovací ventil

Od • je zaručená funkcia.



Vaňový vtok

V tejto oblasti je potrebné zosilnenie steny.



Nepoužitý vývod musí byť zastavený zátkou. (DN 20 3/4")

Je možné použiť len jeden spotrebič, nie dva súčasne.



> 50 l/min

Výkon odtoku musí byť vyšší ako 50 l/min.

Vodovodné potrubie pre bočné sprchy vypáďovať.



Raindrain

Odtok



Exafill

iBox kombinovaný s EXAFILL vaňovým napúšťaním s odpadovou a prepádovou garnitúrou [viď strana 95]



Kompletný vylučovací blok #15956000, nie je súčasťou dodávky

DVGW

mešička baterija za kopolno kad z vgrajeno varovalno kombinacijo (viď strana 96)



Sprchová baterija (viď strana 104, 106, 110, 124)

vaňová baterija (viď strana 98, 102, 114, 116)



Vaňový vtok (viď strana 102)

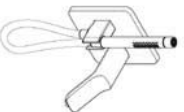



Termostatická batéria
(viď strana 118, 122, 126)



High Flow Termostatická batéria
(viď strana 128 – 138, 142, 144,
150 - 158)



Termostatická batéria s uzatváracím
ventilom
(viď strana 104, 106, 110, 124)



Termostatická batéria s uzatváracou
jednotkou a prestavovacím ventilom
(viď strana 98, 114, 116, 120)

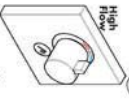

High Flow Termostatická batéria s
uzatváracím ventilom
(viď strana 140, 146, 148)

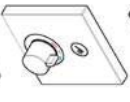

Termostatická batéria s uzatváracím
ventilom
(viď strana 104, 106, 110)

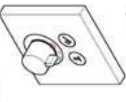

Termostatická batéria s uzatváracím
ventilom
(viď strana 98, 114, 116, 120)



Termostatická batéria s uzatváracím
ventilom
(viď strana 100, 112)

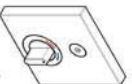

ShowerSelect Sprchová batéria
(viď strana 104, 106, 110)

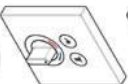

ShowerSelect vaňová batéria
(viď strana 98, 114, 116, 120)



iControl
Uzatvárací a prestavovací ventil (viď
strana 150)

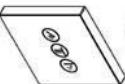

ShowerSelect
3 x uzatvárací ventil (viď strana 144,
146 - 150, 158)



Raindance Showerpipe
(viď strana 108)



Raindance Rainfall 240
(viď strana 140, 142)



Raindance Rainfall 180
(viď strana 154 - 158)



Raindance Select E 300
(viď strana 148)

Raindance E 420
(viď strana 150, 152)

相安装

iBox的旋转对称基体可以作为万能部件使用。在此只能垂直安装。始终在浴缸上侧安装iBox。如果iBox零件即将断裂，水可能从这里流出！

iBox 不仅适用于槽安装。同样也适用于花洒安装。安装单手槽装置/恒温龙头及阀体和分流器单元时，下水口水口优先。安装花洒时，必须使用堵头密封不需要的出水口。

冷热水管间过大的压力差必须予以平衡。

基体安装在热水连接装置左侧和冷水连接装置右侧。

安装深度：80mm至108 mm。

加长 25 mm 商品编号 135950000

加长件22mm（墙壁不够深时）

商品编号 13593000 / 13596XXX / 13597XXX / 15597000 / 19427000 / 97407XXX / 98860000

根据构造的实际情况安装基体。安装范例参见第91页和第 92 页。

- A** 直接墙面安装。
- B** 直接墙面安装，带10 mm可调节的固定柱头螺栓。
- C** 安装在支柱上。
- D** 中空墙壁安装
- E** 砖墙安装
- F** 使用固定组件安装 #96615000。

带数据相管道尺寸的安装实例请从 96 页起查找。所使用符号的说明参见 36 页和 37 页。

本安装说明中所规定的安装尺寸理想用于身高 1800 mm 左右的人士。尺寸可根据需要进行修改。在这种情况下，您必须留意，如果安装高度改变，则花洒到地板的最小高度也随之改变，且必须考虑到连接尺寸的改变。

安装提示

iBox通过管件在台虎钳内处理。这样可以使人连接件。

冲流管系统

按照德国工业标准1988/欧洲标准1717清洗全部安装件。请用手指清洗喷嘴。按流向与该出口导通装置连接。例如：冷水与出口1连接，热水与出口2连接。如果只需要一个出口，那么在第一个清洗过程后，90°旋转冲流嘴。

iBox与下水部件组合 配备出水组件及溢流组件 (参见第95页)

技术参数

工作压力:	最大 1 MPa
推荐工作压力:	0.1 - 0.5 MPa
测试压强:	1.6 MPa
(1 MPa = 10 bar = 1.47 PSI)	
热水温度:	最大 80°C
推荐热水温度:	65°C
中心距高:	G
连接管径:	左热右冷
0.3 MPa时的流速:	
浴缸-淋浴龙头:	31 升/分钟 // 24 升/分钟
浴缸-淋浴龙头及整体式安全组合:	25 升/分钟 // 24 升/分钟
淋浴龙头:	32 升/分钟
恒温龙头:	43 升/分钟
恒温龙头及阀体单元:	26 升/分钟
恒温龙头及阀体和分流器单元:	26 升/分钟
恒温龙头 High Flow:	58 升/分钟
iControl:	30 升/分钟

X

槽中间 / 中心淋浴盆



截止阀

Y

尺寸Y = 软管壁出口弯管的中心至浴盆加水口中心除以2 (匹配瓷砖布置)。

Quattro 四通转换器



Quattro

通用的三通截止阀和换向阀



热水

冷水



Trio

从开始, 正常功能得以保证。

浴缸出水口



该区域需要一个加固边缘。

插入不使用的插座。(DN 20 *)



只有一项功能。

排水功率必须大于 50 l/min.



安装水管, 用于带有梯度的淋浴器。

排水口



Raindrain



Exofill

Box与下水部件组合, 配备出水组件及溢流组件 (参见第95页)



DVGW

浴缸淋浴龙头及整体式安全组合
(参见第96)

淋浴龙头:
(参见第104, 106, 110, 124)



浴缸—淋浴龙头
(参见第98, 102, 114, 116)



浴缸出水口
(参见第102)

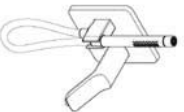



恒温龙头
(参见第页 118, 122, 126)



Shower>Select 淋浴龙头
(参见第页 104, 106, 110)



High Flow 恒温龙头
(参见第页 128, 138, 142, 144,
150 - 158)

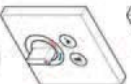

Control
截止阀和换向阀 (参见第页 150)



恒温龙头及闭锁单元
(参见第页 104, 106, 110, 124)



恒温龙头及闭锁和分流器单元
(参见第页 98, 114, 116, 120)



Shower>Select
3 x 停止阀 (参见第页 144, 146 -
150, 158)

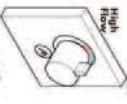

High Flow 恒温龙头及闭锁单元
(参见第页 140, 146, 148)



Raindance Showerpipe
(参见第页 108)



恒温龙头及闭锁单元
(参见第页 104, 106, 110)



Raindance Rainfall 240
(参见第页 140, 142)

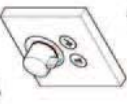

恒温龙头及闭锁单元
(参见第页 98, 114, 116, 120)



Raindance Rainfall
180
(参见第页 154 -
158)



恒温龙头及闭锁单元
(参见第页 100, 112)



Raindance E 420
(参见第页 150, 152)



Raindance Select E 300
(参见第页 148)

Предварительный монтаж

Вращательно-симметричный корпус Вох может использоваться универсально, как горизонтально, так и вертикально. Кроме монтажа арматуры ванны с комбинированным предохранителем здесь возможно только вертикальное установление. Поскольку при неисправности функциональных деталей у Вох может выкачать вода, Вох необходимо монтировать над ванной, чтобы выступающая вода могла стекать в ванну!

Вох предназначен для монтажа как ванн, так и душей. Для однорычажного смесителя для ванны / термостата с запорным и регулировочными клапанами преимущество имеет нижний отвод. При монтаже душа наилучший выход необходимо закрыть пробкой, донного клапа. Перед установкой смесителя необходимо регулировочными кранами выровнять давление холодной и горячей воды при помощи вентилей регулирующих подачу воды в квартиру.

Установите корпус так, чтобы подключение горячей воды находилось слева, а холодной – справа.

Глубина установки от 80 до 108 мм.

Удлинение 25 мм орг. № 13595000

Удлинение 22 мм (при малой глубине установки)

орг. № 13593000 / 13596XXX / 13597XXX /
15597000 / 19427000 / 97407XXX / 98860000

Корпус может монтироваться, согласно условиям

строительств, примеры монтажа см. на стр. 91 и 92.

A варианты установки

В Установка на стене. Здесь с гибким распорным держателем, благодаря винтам 10.

С Монтаж на системе стоек.

D Установка на монтажных шпильках сборных донов или блоках сборных домов.

E монтаж в кирпичную стену

F Установка с помощью комплекта монтажных шин #96615000.

Примеры монтажа с указанием размеров и размеров трубопровода см. на стр. 96. Пояснение к исполнению см. в символах см. на стр. 39 и 40.

Указанные в монтажной инструкции монтажные размеры являются для лиц ростом около 1800 мм. В случае необходимости монтажные размеры следует менять. При этом нужно учесть, что при изменении высоты монтажа меняется также и минимальная высота, а изменение установочных размеров нужно принять во внимание.

Подсказка по монтажу

Для завысивания фитингов закрепите Вох с помощью куска трубы в тисках.

Промывка

Промойте все установленное оборудование, согласно DIN 1988 / EN 1717. Срепки на промывочном блоке показывают, какой вход связан с отводом, напр., холодная вода с отводом 1, а горячая вода - с отводом 2. Если требуется только один отвод, после первой промывки промывочный блок необходимо повернуть на 90°.

Вох в комбинации со впускном ванной ExaFill со сливной и переливной гарнитурой (см. стр. 95)**Технические данные**

Рабочее давление:	не более, 1 МПа
Рекомендуемое рабочее давление:	0,1 - 0,5 МПа
Давление:	1,6 МПа
(1 МПа = 10 bar = 147 PSI)	
Температура горячей воды:	не более, 80°С
Рекомендуемая темп. гор. воды:	65°С
Размеры подключения:	G ¾
Подключение:	холодная справа - горячая слева
Свободное истечение при 0,3 МПа:	
Смеситель ванны:	31 л/мин // 24 л/мин
Смеситель ванны со встроенным комбинированным предохранителем:	25 л/мин // 24 л/мин
Смеситель душа:	32 л/мин
Термостат:	43 л/мин
Термостат с запорным вентилем:	26 л/мин
Термостат с запорным и переключающим вентилем:	
26 л/мин	
Термостат High Flow:	58 л/мин
iControl:	30 л/мин

X

Середина ванны / Середина душевой ванны



Скрытый вентиль

Y

Размер Y – середина дуги подключения шланга, деленная на 2 (или подогнуть пор распр. плитки).



Quattro

Четырехходовой переключатель Quattro

Теплая вода

Холодная вода



Trio

Трехходовой запорный и переключающий вентиль Trio Universal



Гарантированное функционирование при показателях выше *



Водозабор



В этой области требуется укрепление стены.



Ненужный выход необходимо уплотнить с помощью заглушки. (DN 20 3/4")



Возможно использование только одного обогревателя, не двух одновременно.



Водопроводы для боковых душей прокладывают под наклоном.



> 50 л/мин

Слив

Слив должен иметь пропускную способность более 50 л/мин.



Промывочный блок кпл. # 15926000, не включено в объем поставки!



Raindrain



Exall

!Вox в комбинации со выпуском ванны Exall со сливной и переливной гарнитурой (см. стр. 95)

ДУШ



Смеситель ванны со встроенным комбинированным предохранителем (см. стр. 96)



Смеситель душа (см. стр. 104, 106, 110, 124)



Смеситель ванны (см. стр. 98, 102, 114, 116)

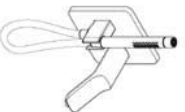

Водозабор (см. стр. 102)



Термостат
(см. стр. 118, 122, 126)



High Flow Термостат
(см. стр. 128 - 138, 142, 144, 150 - 158)



Термостат с запорным венчиком
(см. стр. 104, 106, 110, 124)



Термостат с запорным и переключающим венчиком
(см. стр. 98, 114, 116, 120)

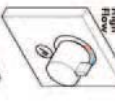

High Flow Термостат с запорным венчиком
(см. стр. 140, 146, 148)

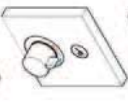

Термостат с запорным венчиком
(см. стр. 104, 106, 110)

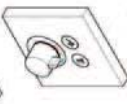

Термостат с запорным венчиком
(см. стр. 98, 114, 116, 120)



Термостат с запорным венчиком
(см. стр. 100, 112)



ShowerSelect Смесьтедь душа
(см. стр. 104, 106, 110)



ShowerSelect Смесьтедь ванны
(см. стр. 98, 114, 116, 120)



Control
Запорный и переключающий венчик
(см. стр. 150)

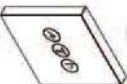

ShowerSelect
3 x Запорный клапан (см. стр. 144, 146 - 150, 158)



Raindance Showerpre
(см. стр. 108)



Raindance Rainfall 240
(см. стр. 140, 142)



Raindance Rainfall 180
(см. стр. 154 - 158)



Raindance E 420
(см. стр. 150, 152)



Raindance Select E 300
(см. стр. 148)

Gőszerezés

Az IBox szimmetrikus rotációjú belső szerelékével együtt univerzálisan – vízszintesen és függőlegesen egyaránt – elhelyezhető. A biztonsági szerelvényrel ellátott kádcsaptelep kivételével, itt csak a függőleges beépítés lehetséges. Mivel a működő részek meghibásodásakor víz kerülhet az IBoxra, ezért az IBox-ot a kád fölé kell felszerelni, hogy a kifolyó víz a kádba folyhasson!

Az IBox kádhoz és tusolóhoz egyaránt alkalmas. Egykörös kádcsaptelep / elzáró- és váltószeleppel rendelkező termosztát esetében az első kiállítás az elsődleges.

Zuhanycsaptelep szerelése esetén a használaton kívüli kiállást vakudóval kell lezárni.

A hidegvíz- és a melegvíz-csatlakozások közötti nagy nyomáskülönbséget kikéll egyenlíteni!

Az alaptestet úgy szereljük be, hogy a melegvíz csatlakozása bal oldalra, míg a hidegvíz csatlakozása jobb oldalra kerüljön.

Beépítési mélység: 80 – 108 mm

Hosszabbítás: 25 mm cikkszám 13595000

Hosszabbító készlet: 22 mm (kis beépítési mélység esetén)

cikkszám 13593000 / 13596XXX / 13597XXX / 15597000 / 19427000 / 97407XXX / 98860000

Az alaptestet az építészeti adottságoknak megfelelően szereljük be. A szerelési példákot lásd a 91. és a 92. oldalon.

A Szerelés közvetlenül a falra.

B Törvörös szerkezete való szerelés.

C Tartórendszerre szerelés.

D Szerelés készítőszerszerekre vagy kész cellákra.

E Szerelés falba súlysztre.

F Szerelés szerelési-szettel #96615000.

Fel szerelési példák méretekkel és vezeték-dimenziókkal az 96 oldalán kezdődően találhatók. A használt szimbólumok magyarázatait az 42 és 43 oldalon találhatók.

A szerelési útmutatóban megadott szerelési méretek kb. 1800 mm term magasságú személyneknek alkalmasok, és ennek megfelelően dimenzionozók. Itt arra kell ügyelni, hogy az dimenzionozott szerelési magasságnál megváltozik a minimális magasság és figyelembe kell venni a csatlakozó méreteinek változását.

Szerelési ötlet

A csatlakozó közdarabok becsavarásához - egy cső segítségével - fogjuk sabta az IBox-ot.

Átöblítés

Öblítsük át a teljes szerelvényt a DIN 1988 sz. szabvány előírásainak megfelelően. Az öblítőblokkon látható nyílak mutatják, hogy melyik beömös vezeték melyik lefolyó vezetékhez kapcsolódik, így pl. a hidegvíz vezetéke az 1. kiállításhoz és a melegvíz vezetéke a 2. kiállításhoz.

Amennyiben csupán egyetlen kiállításra van szükség, az első öblítési műveletet követően forgrassuk el 90°-kal az öblítő-blokkot.

IBox, valamint Exafill kádöblítő, le- és rúfolyó kombinációja (lásd a 95. oldalon)

Műszaki adatok

Üzemi nyomás:	max. 1 MPa
Állított üzemi nyomás:	0,1 - 0,5 MPa
Nyomáspróba: (1 MPa = 10 bar = 147 PSI)	1,6 MPa
Forróvíz hőmérséklet:	max. 80° C
Forróvíz (javosolt) hőmérséklete:	65° C
Csatlakozási méret:	G $\frac{3}{4}$
Csatlakozási:	hideg jobbra - meleg balra
Szabod átfolyás 0,3 MPa nyomás esetén:	
Kádcsaptelep:	31 l/perc // 24 l/perc
Kádcsaptelep beépített biztonsági egységgel:	25 l/perc // 24 l/perc
Zuhanycsaptelep:	32 l/perc
Termosztát:	43 l/perc
Termosztát elzárószeleppel:	26 l/perc
Termosztát elzáró- és váltószeleppel:	26 l/perc
Termosztát High Flow:	58 l/perc
iControl:	30 l/perc

X A kád közepe / Zuhanyláda közepe



Falisk alatti szelep

Y Y méret – a csőcsatlakozó közepétől a kád/lelté behelyező közepéig; osztva kettővel (szükség esetén a csempé kiosztásához igazítva).



Quattro négyvutas dióalakú

Melegvíz

Quattro

Trio univerzális zár- és váltószelep

Hidegvíz



Trio

Kádbevezetés



A • -tól működik az adott funkció.



A főleges kimenetel vaskingóval kell lezárni. (DN 20 3/4")



Ezen a területen a fal megerősítésére van szükség.



A lefolyó teljesítményének 50l/percnel magasabbnak kell lenni



> 50 l/min

Lefolyó

Egyidejűleg csak egy fogyasztót lehet használni, két fogyasztó (zuhanyrózsa, oldozózuhanyok) egyszerre nem tud működni. Az oldalzuhanyokhoz a vízvezetékkel lejtéssel ajánlott beszerelni.



Raindrain

iBox, valamint Exafill kádtelelő, le- és túlfolyó kombinációja (lásd a 95. oldalon)



Exafill



Öblítőblokk csatlakozó #15956000, a szállítási egység nem tartalmazza

DVGW

Kádcsaptelep beépített biztonsági

egységgel (lásd a oldalon 96)



Zuhanycsaptelep (lásd a oldalon 104, 106, 110, 124)



Kádcsaptelep (lásd a oldalon 98, 102, 114, 116)

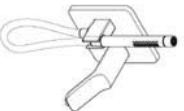

Kádbevezetés (lásd a oldalon 102)



Termosztár
(lásd a oldalon 118, 122, 126)



High Flow Termosztár
(lásd a oldalon 128 - 138, 142, 144, 150 - 158)



Termosztár elzárószelleppel
(lásd a oldalon 104, 106, 110, 124)



Termosztár elzáró- és változószelleppel
(lásd a oldalon 98, 114, 116, 120)

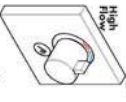

High Flow Termosztár elzárószelleppel
(lásd a oldalon 140, 146, 148)

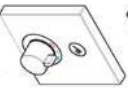

Termosztár elzárószelleppel
(lásd a oldalon 104, 106, 110)

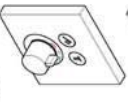

Termosztár elzárószelleppel
(lásd a oldalon 98, 114, 116, 120)



Termosztár elzárószelleppel
(lásd a oldalon 100, 112)

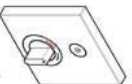

ShowerSelect Zuhanycsaptelep
(lásd a oldalon 104, 106, 110)

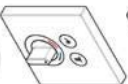

ShowerSelect Kódcsaptelep
(lásd a oldalon 98, 114, 116, 120)



iControl
Záró- és váltószelep (lásd a oldalon 150)

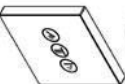

ShowerSelect
3 x Elzárószelep (lásd a oldalon 144, 146 - 150, 158)



Raindance Showerpipe
(lásd a oldalon 108)



Raindance Rainfall 240
(lásd a oldalon 140, 142)



Raindance Rainfall 180
(lásd a oldalon 154 - 158)



Raindance E 420
(lásd a oldalon 150, 152)



Raindance Select E 300
(lásd a oldalon 148)

Raaka-asetennus

Pyrölysymmeirinen iBox:iin peruskappale on yleiskäyttöinen, sen voi asentaa sekä pysty-, että vaakasuoraan. Poikkeuksena sellaisien ammealtahuri, joissa on varmuuskombinaatio, tällöin vain vaakasuora asennus on mahdollinen. Koska iBox:ista voi valua vettä toimintaosien vahingoittuessa, iBox on asennettava ammeen yläpuolelle, jotta valuva vesi pödtsee voluunaan ammeeseen! iBox soveltuu sekä amme- että myös suihkuasennukseen. Lähtö 1 on tarkoitettu etupäässä yksikäsi ammesekoittimelle / sulku- ja vaihtoventtiilillä varustetulle termostahtille. Suihkuasennuksessa käyttömättä jääny lähtö pitää tiivistää sulkuhalpualla.

Suurit paineeroat kylmä- ja kuumovesilinjantöiden välillä on tsastava.

Asenna peruskappale siten, että lamminvesilinjantö tulee vasemmalle ja kylmävesilinjantö aino oikealle puolelle.

Asennussyvyys 80 mm - 108 mm.

Pidemmys 25 mm luotenumero 13599000

Pidemmys 22 mm (pienemmällä asennussyvyydellä)

Luotenumero 13593000 / 13596XXX / 13597XXX / 15597000 / 19427000 / 97407XXX / 98860000

Peruskappaleen voi asentaa rakennuksen asetoniamen reunuehlojen mukaisesti, katso asennusmerkkejä sivulla 91 ja 92.

A Asennus seinään

B Asennus seinään. Tässä jousistavaa etäisyysdempintä käyttöäen kokosierkeistillä 10 mm ruuveilla.

C Asennus kannattinjärjestelmään

D Asennus valmistalo-asennuslevylle tai valmistaloihin.

E Asennus suoraan seinään.

F Asennus käyttöäen asennusko-sarjaa #96615000.

Asennusmerkit mitoittoineen ja purkilehtiöineen löytyvät alkaen sivulla 96. Käytettyjen merkkien selitys sivulla 45 ja 46.

Asennusohjeessa annettut asennusmitat sopivat n. 180 cm:n pituiselle henkilöille, ja niitä on tarvittaessa muutettava. Tässä on otettava huomioon, että asennusko-korkeuden muutussa muuttuu myös vähimmäiskorkeus, ja muutos on otettava huomioon linjatöiden mittoissa.

Asennusvihje

Kiinnitä iBox purkennöikän avulla ruuviipenkkiin, jotta saat kierrettyä liittokappaleet sisään.

Huuhdtelu

Koko asennetta järjestelmää on huuhdteltava DIN 1988 / EN 1717 mukaisesti. Huuhdtelulohkossa olevat suolet osoittavat mikä tulo on liittettyä mihinkin lähtöön, esim. kylmävesi lähtöön 1 ja lämminvesi lähtöön 2. Jos tarvitaan vain 1 lähtö, ensimmäisen huuhdtelun jälkeen huuhdtelulohkkoa on kierrätävä 90°.

iBox yhdessä Exafill ammeentyttöhäna varustettuna tyhjennys- ja ylivuoto-varustella (katso sivu 95)

Tekniset tiedot

Käyttöpaino:	maks. 1 MPa
Suosittelu käyttöpaino:	0,1 - 0,5 MPa
Koestuspaino:	1,6 MPa
(1 MPa = 10 bar = 147 PSI)	
Kuuman veden lämpötila:	maks. 80 °C
Kuuman veden suositlämpötilat:	65 °C
Liitäntämittat:	G ¾
Liittimet:	kylmä oikealla - kuuma vasemmalla
Vapaa läpivirtaus 0,3 MPa paineella:	31 l/min // 24 l/min
Ammesekoittaja:	Ammesekoittaja integroidulla turvayhdistelmällä:
	25 l/min // 24 l/min
Suihku-sekoittaja:	32 l/min
Termostahti:	43 l/min
Termostahti sulkuventtiilillä:	26 l/min
Termostahti sulku- ja vaihtoventtiilillä:	26 l/min
Termostahti High Flow:	58 l/min
Control:	30 l/min

X Ammeen keskus- / Suikkuvalton keskus



Upotettava venttiili

Y

Mitta Y – etäisyys leikuriliitäntäkaoren keskeltä ammeen huloaukon keskelle jaettuna kahdella (sovitus mahdollisesti laajitusrudukkoon).

4-tiesäätöventtiili



Quattro

Lämmin vesi

Trio -suiku- ja säätöventtiili

Kylmä vesi



Trio



Tämä toiminta on taattuina • alkoen.

Vedenhulo ammeeseen



Tässä kohdassa seinää on vahvistettava

Käytännön lähtötilin on suljettava suikku-
tulpolla. (DN 20 3/4")



Vain yksi vedenkyttopiste kerrallaan on mahdollista, ei kahla samanaikaisesti.

Poisvirtaustehon on oltava enemmän kuin
50l/min.



Vie sivusuuhkujen syöttöputket alaspäin
laskuvasi.



Raindrain

iBox yhdessä Exafill ammeentytöhöna
varusteltuna 'yhjennys- ja ylivuotovarustel-
la' (katso sivu 95)



Exafill



DVGW

Ammeeskoittaja integroidulla
turvayhdistelmällä
(katso sivu 96)



Suikkueskoittaja
(katso sivu 104, 106, 110, 124)



Ammeeskoittaja
(katso sivu 98, 102, 114, 116)



Vedenhulo ammeeseen
(katso sivu 102)

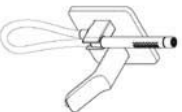



Termostaatti
(katso sivu 118, 122, 126)



High Flow Termostaatti
(katso sivu 128 - 138, 142, 144,
150 - 158)



Termostaatti sulkuventtiilillä
(katso sivu 104, 106, 110, 124)



Termostaatti sulku- ja vahivoventtiilillä
(katso sivu 98, 114, 116, 120)

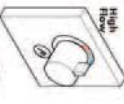

High Flow Termostaatti sulkuventtiilillä
(katso sivu 140, 146, 148)

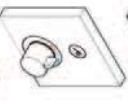

Termostaatti sulkuventtiilillä
(katso sivu 104, 106, 110)

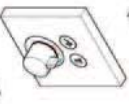

Termostaatti sulkuventtiilillä
(katso sivu 98, 114, 116, 120)



Termostaatti sulkuventtiilillä
(katso sivu 100, 112)



ShowerSelect Suikukehoittaja
(katso sivu 104, 106, 110)

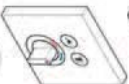

ShowerSelect Armesekoittaja
(katso sivu 98, 114, 116, 120)



iControl
Sulku- ja sätöventtiili (katso sivu 150)

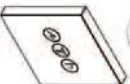

ShowerSelect
3 x Sulkuventtiili (katso sivu 144, 146
- 150, 158)



Raindance Showerpipe
(katso sivu 108)



Raindance Rainfall 240
(katso sivu 140, 142)



Raindance Rainfall 180
(katso sivu 154 - 158)



Raindance E 420
(katso sivu 150, 152)



Raindance Select E 300
(katso sivu 148)

Grundmontering

Den rotationsymmetriska grundkonstruktionen hos iBox är universellt användbar, så väl horisontellt som vertikalt. Detta gäller dock inle för monteringen av kararmatur med säkerhetskombination; här är endast vertikal monteringen möjlig. Eftersom vatten kan tränga ut vid iBoxens om funktionsdelar är defekta så måste iBoxen monteras över karell så att det vatten som kommer ut kan rinna ner i karell

iBox är avsedd för såväl kar- som duschinstallation. Till enhandsblandare / termostat med spärr- och omställningsventil används främst det undre utloppet. Vid installation i dusch måste man sätta en propp i det utlopp som inle behövs så att detta är tät.

Stora tryckskillnader mellan anslutningarna för varmt och kallt vatten måste utjämnas.

Montera grundkonstruktionen så att varmvattensanslutningen sitter till vänster och kallvattenslutningen till höger.

Monteringsdjup 80 mm till 108 mm.

Förlängning 25 mm artikelnummer 13595000

Förlängning 22 mm (vid liet monteringsdjup)

Artikelnummer 13593000 / 13596XXX / 13597XXX / 15597000 / 19427000 / 97407XXX / 98860000

Grundkonstruktionen monteras enligt de förutskrivningar som gäller på platsen, se monteringsexempel på sidor 91 och 92.

A Vöginstallation.

B Vöginstallation. Här med flexibel avståndshållare genom skruvsift storl. 10.

C Montering på stödsystem.

D Installation på monteringsplattor till färdighus eller färdigsektioner.

E Installation direkt i väggen.

F Installation med monteringskänset #96615000.

Du hittar installationsexempel med uppgifter om mått och ledningsdimensioner från sidan 96. Förklaringen till de använda symbolerna på sidan 48 och 49.

De monteringsmått som anges i monteringsanvisningen passar 1,80 m långa personer och måste eventuellt anpassas. Det är då viktigt att tänka på att den minsta höjden ändras när monteringshöjden blir en annan och att hänsyn måste tas till de ändrade anslutningsmåtten.

Monteringsstips

Sätt fast iBox i skruvvingen med hjälp av ett rör när anslutningsstycken ska skrivas in.

Spola

Spola igenom hela installationen enligt DIN 1988 / EN 1717. Plåtarna på spolblocket visar vilken inkommande ledning som är ansluten till vilket utlopp, t.ex. kallvatten till utlopp 1 och varmvatten till utlopp 2. Om det bar behövs ett utlopp måste spolblocket vridas 90° efter första spolningen.

iBox i kombination med ett Exafill karinlopp med från- och överrinningsset (se sidan 95)

Tekniska data

Drifttryck:	max. 1 MPa
Rek. drifttryck:	0,1 - 0,5 MPa
Tryck vid provtryckning: (1 MPa = 10 bar = 1,47 PSI)	1,6 MPa
Varmvattentemperatur:	max. 80 °C
Rek. varmvattentemp.:	65 °C
Anslutningsmått:	G ¾
Anslutningar:	kallt höger - varmt vänster
Fri genomströmning vid 0,3 MPa:	31 l/min // 24 l/min
Karbländare:	
Karbländare med integrerad säkerhetskombination:	25 l/min // 24 l/min
Duschblandare:	32 l/min
Termostat:	43 l/min
Termostat med spärrventil:	26 l/min
Termostat med spärr- och omställningsventil:	26 l/min
Termostat High Flow:	58 l/min
iControl:	30 l/min

X

Mitt på boddar / Mitten av duschkaret



Invändigt ventil

Y

Mitt Y – mitten av slanganslutningskrök till mitten av karntlopp delar med två (om passa eventuellt till kakelmönstret).



Quattro Fyrvägssomkastare

Varmvatten

Kallvatten



Trio Universell ovsättningsventil och omkastare

Frän • garantieras funktionen.



Badarkstjän

Stoje zonolja bütinas sienos svrtvrtinnos



Det utlopp som inte behövs måste tätas med en blindstopp. (DN 20 3/4")

Endast en enhet möjlig, inte två samtidigt.



Avloppet måste klara mer än 50 l/min.

Drag vottenledningar till sidoduschar med fall.



Avlopp

Raindrain



iBox i kombination med ett Exofill karntlopp med från- och överrinningsset (se sidan 95)

Spolblock kompl. #15956000, medföljer ej leveransen

DVGW

Karntloppare med integrerad säkerhetskombination (se sidan 96)



Duschblandare (se sidan 104, 106, 110, 124)

Karntloppare (se sidan 98, 102, 114, 116)



Badarkstjän (se sidan 102)

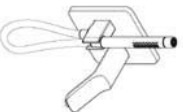



Termostat
(se sidan 118, 122, 126)



High Flow Termostat
(se sidan 128 - 138, 142, 144, 150 - 158)



Termostat med spårventil
(se sidan 104, 106, 110, 124)



Termostat med spår- och omställingsventil
(se sidan 98, 114, 116, 120)

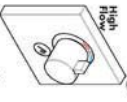

High Flow Termostat med spårventil
(se sidan 140, 146, 148)

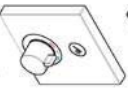

Termostat med spårventil
(se sidan 104, 106, 110)

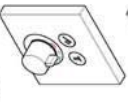

Termostat med spårventil
(se sidan 98, 114, 116, 120)



Termostat med spårventil
(se sidan 100, 112)

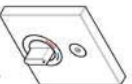

ShowerSelect Duschblandare
(se sidan 104, 106, 110)

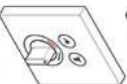

ShowerSelect Karblandare
(se sidan 98, 114, 116, 120)

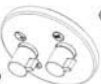

iControl
Avstängningsventil och omkastare (se sidan 150)

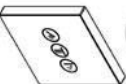

ShowerSelect
3 x Spårventil (se sidan 144, 146 - 150, 158)



Raindance Showerpipe
(se sidan 108)



Raindance Rainfall 240
(se sidan 140, 142)



Raindance Rainfall 180
(se sidan 154 - 158)

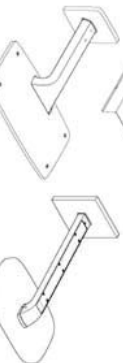

Raindance E 420
(se sidan 150, 152)

Raindance Select E 300
(se sidan 148)

Bazinis montavimas

Simetriškai beieskančias iBox pagrindą galima įstatyti tiek horizontaliai, tiek vertikaliai. Kai įrengiama vonios armačiūra su apsauginiu rinkiniu, įmontuoti galima tik vertikaliai. "iBox" visada montuojkite virš vonios, kad atširdus problemai su funkcinėmis dalimis, vanduo galėtų į ją nubėgti!

iBox tinka tiek voniai, tiek ir dušui. Viena ranka veldamuo-se maštytuvuose / termostatuose su uždarymo vožtuvais ir skirstytuvais pirmenybė teikiama apotiniam išvadui.

Įrengdami dušą, nereikalingą išvadą sandorai uždenkite kaišu.

Turi būti išlyginti šalto ir karšto slėgio nelygumai.

Pagrindą sumontuokite taip, kad karšto vandens jungtis būtų kairėje, o šalto - dešinėje.

Montavimo gylis: nuo 80 mm iki 108 mm.

Ilgkis 25 mm Art.Nr. 13595000

Ilgkis 22 mm, esant nepakankamam sienos gyliai:

Art.Nr. 13593000 / 13596XXX / 13597XXX / 15597000 / 19427000 / 97407XXX / 98860000

Pagrindą galite sumontuoti pagal vietos sąlygas, montavimo pavyzdžiai pateikti 91 ir 92 psl.

A Montavimas į sieną.

B Montavimas į sieną su specialiais reguluojamais 10 mm varžtais.

C Montavimas prie laikončios sistemos.

D Montavimas ant montavimo plokščių.

E Montavimas į sieną.

F Montavimas su montavimo rinkiniu #96615000.

Įrengimo pavyzdžiai su nurodytais matmenimis ir vamzdymo dyžiais pateikti 96 puslapyje. Variojanų simbolių paaiškinimai pateikti 51 ir 52 puslapiuose.

Montavimo instrukcijoje nurodyti išmatavimai idealiai tinka 1800 mm ūgio žmonėms. Galima keisti aukštį, bet tuomet keičiasi minimalus rekomenduojamas patalpų aukštis ir turi būti atsižvelgiama į vandens jungties matmenų pasikeitimą.

Montavimo patarimas

Norėdami įsukti jungiamuosius elementus, vamzdžiui įvertinkite iBox spaustuvuose.

Išplaukite

Pagal DIN 1988 / EN 1717 išplaukite visą įrangą. Rodykles ant plunomomo bloko rodo, kuriuos įvadus ir išvadu vamzdžius reikia sujungti tarpusavyje, pavyzdžiui, 1 šalto vandens išvadą su 2 karšto vandens išvadu. Jei reikia - lingas tik vienas išvadas, po pirmojo plovimo pasukite plunomomą bloką 90°.

iBox kartu su Exafill vonios čiaupu ir išleidimo bei apsauginės angos rinkiniais (žr. psl. 95)

Techniniai duomenys

Darbinis slėgis:	ne daugiau kaip 1 MPa
Rekomenduojamas slėgis:	0,1 - 0,5 MPa
Bandomasis slėgis:	1,6 MPa
(1 MPa = 10 barų = 147 PSI)	
Karšto vandens temperatūra:	ne daugiau kaip 80 °C
Rekomenduojama karšto vandens temperatūra:	65 °C
Aštimas tarp centri:	G ¾
Prijungimas:	Šaltas vanduo dešinėje, karštas - kairėje
Laisvas vandens protididimas esant 0,3 MPa slėgiui:	31 l/min // 24 l/min
maštytuvos voniai:	
maštytuvos voniai su integruota apsaugos sistema:	25 l/min // 24 l/min
dušo maštytuvas:	32 l/min
Termostatas:	43 l/min
Termostatas su uždarymo vožtuvu:	26 l/min
Termostatas su uždarymo vožtuvu ir skirstytuvu:	26 l/min
Termostatas High Flow:	58 l/min
iControl:	30 l/min

X

Vonios viduryje / Dušo padėklų centras



Porčkinis uždarymo vožtuvas

Y

Matmuo Y = atstumas nuo dušo žarnos jungties centro iki čiupo centro, padalinus iš 2 (lei įmanoma, laikykite prie plytelių).



„Quattro“ 4krypčių perjungimas

Šiltas vanduo



Užvarnis ir perjungimo vožtuvas „Trio Universal“

Šaltas vanduo



Trio

Nuo • funkcionavimas garantuotas



Vonios įeiga

Šioje zonoje būtinas sienos sutvirtinimas



Nenaudojamą išėjimą užklikti. (DN 20 3/4")

Vienu metu galima tik viena funkcija.



Nulekėjimo našumas turi būti ne mažesnis 50 l/min

Privesiti vamzdičius šoniniams purkštukams.



Nulekėjimas



Plaunamojo bloko jungtis # 159256000, nėra pridėdama



Raindrain

iBox kartu su Exfill vonios čiupu ir išleidimo bei apsauginės angos rinkiniais (žr. psl. 95)



Exfill

DVGW



maišyvuvas voniai su integruota apsaugos sistema (žr. psl. 96)



dušo maišyvuvas (žr. psl. 104, 106, 110, 124)



maišyvuvas voniai (žr. psl. 98, 102, 114, 116)

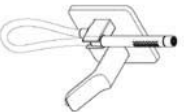

Vonios įeiga (žr. psl. 102)



Termostatas
(žr. psl. 118, 122, 126)



High Flow Termostatas
(žr. psl. 128 - 138, 142, 144, 150 - 158)



Termostatas su uždarymo vožtuvu
(žr. psl. 104, 106, 110, 124)



Termostatas su uždarymo vožtuvu ir skisrytuvu
(žr. psl. 98, 114, 116, 120)

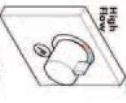

High Flow Termostatas su uždarymo vožtuvu
(žr. psl. 140, 146, 148)

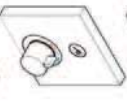

Termostatas su uždarymo vožtuvu
(žr. psl. 104, 106, 110)

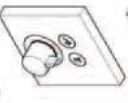

Termostatas su uždarymo vožtuvu
(žr. psl. 98, 114, 116, 120)



Termostatas su uždarymo vožtuvu
(žr. psl. 100, 112)



ShowerSelect dušo mašyvuvas
(žr. psl. 104, 106, 110)

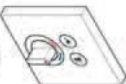

ShowerSelect mašyvuvas voniai
(žr. psl. 98, 114, 116, 120)



Control
Užvarinis ir perjungimo vožtuvas [žr. psl. 150]

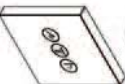

ShowerSelect
3 x Uždarymo vožtuvas [žr. psl. 144, 146 - 150, 158]



Raindance Showerpipe
(žr. psl. 108)



Raindance Rainfall 240
(žr. psl. 140, 142)



Raindance Rainfall 180
(žr. psl. 154 - 158)



Raindance E 420
(žr. psl. 150, 152)

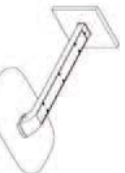

Raindance Select E 300
(žr. psl. 148)

Priprema montaže

Rotacijsko simetrično tijelo jedinice iBox je univerzalno primjenljivo, kako horizontalno tako i vertikalno. Iznimku predstavlja montaža armatura za kade sa sigurnosnom kombinacijom, kod koje je moguća samo vertikalna ugradnja. Budući da kod kvora pojedinih dijelova iz iBox-a može otecati voda, iBox je potrebno instalirati iznad kade kako bi voda mogla otecati u kadu!

iBox je pogodan za ugradnju na tuš kade i kade. Kod jednoručnih mješalica za kade / termostat sa ventilom za zatvaranje i ventilom selektora prioritetan je donji izlaz. Kod instalacije na tuš kadi izlaz koji se ne koristi treba zaštititi čepom.

Velika razlika u pritišku između vruće i hladne vode mora biti izbalansirana.

Montirajte tijelo tako da se priključak tople vode nalazi na lijevoj, a hladne na desnoj strani.

Dubina ugradnje 80 - 108 mm.

Produljenje 25 mm br. Proizvoda 13595000

Produljenje 22 mm (kod manje dubine ugradnje)

br. Proizvoda 13593000 / 13596XXX / 13597XXX / 15597000 / 19427000 / 97407XXX / 98860000

Tijelo se može montirati u skladu s uvjetima koji vladaju na mjestu postavljanja, primjeri montaže mogu se naći na stranicama 91 i 92.

A Direktna instalacija u zid.

B Direktna instalacija u zid sa 10 mm podešivim vijcima

C Montaža na susstav nosača.

D Instalacija u montažne ploče

E Instalacija u zid od cigle.

F Instalacija sa setom instalacijskih udloga #96615000.

Primjeri instalacija s veličinama i dimenzijama vodova mogu se naći od stranice 96 nadalje. Pojašnjenje korištenih simbola nalazi se na stranici 54 i 55.

Montažne dimenzije navedene u uputama za montažu iduće su za osobe visine oko 1800 mm te se prema potrebi moraju prilagoditi konkretnoj visini korisnika. Pri tom valja uzeti u obzir da se u slučaju promjene montaže visine mijenja i minimalna visina koo i da se tada mora uvažiti i promjena priključnih dimenzija.

Savjet u vezi montaže

Za uvrtnje priključnih elemenata iBox treba zategnuti u stepu uz pomoć komada cijevi.

Ispiranje

Kompletnu instalaciju treba ispirati sukladno DIN 1988 / EN 1717. Strelica na bloku prikazuju koji je dovod spojen s kojim odvodom, npr. hladna voda s odvodom 1, a topla voda s odvodom 2. Ukoliko je potreban samo jedan odvod, onda se nakon prvog ispiranja blok mora zakrenuti za 90°.

iBox u kombinaciji s Exafill ispuštom u kadu s odvodnom i prelivnom garniturom (pogledaj stranicu 95)

Tehnički podatci

Najveći dopušteni tlak:	tlak 1 MPa
Preporučeni tlak:	0,1 - 0,5 MPa
Probi tlak:	1,6 MPa
(1 MPa = 10 bar = 147 PSI)	
Temperatura vruće vode:	tlak 80 °C
Preporučena temperatura vruće vode:	65 °C
Raznost od sredine:	G ¾
Spojevi:	hladna desno - topla lijevo
Slobodan protok na 0,3 MPa:	31 l/min // 24 l/min
Mješalica za kadu:	25 l/min // 24 l/min
Mješalica za kadu u ugrađenim sigurnosnim suslovom:	32 l/min
Mješalica tuša:	43 l/min
Termostati:	26 l/min
Termostat sa izolacijskim ventilom:	58 l/min
Termostat sa ventilom za zatvaranje i ventilom selektora:	30 l/min
26 l/min	
Termostat High Flow:	58 l/min
iControl:	30 l/min

X Sredina kade / Sredina tuškada  Podzbukni ventil

Y Mjera Y – sredina priključka crijeva do sredine filtera kade podijeljeno sa 2 (eventualno pogoditi rasteru pločica)  Quattro četrverostruki preusmjernič

Topla voda  Trio Universal ventil za zatvaranje i ventil selektora

Hladna voda  Trio

Zajamčena funkcija od • naviše  Ispust u kadu

U ovom je području poštebno ojačanje zida.  Potrebno je otvoriti zatvoren izlaz koji se ne koristi (DN 20 ¾“)

Moguće je koristiti samo jedno trošilo, nikako dva istovremeno!  Protok vode mora biti veći od 50 l/min.

Položite vodovodne cijevi za bočni tuš s nagibom  Odvod

 kompletni blok # 15956000, Nije sadržano u isporuci

 Raindrain  Exafill  iBox u kombinaciji s Exafill ispuštom u kadu s odvodnom i preljevnom garniturom (pogledaj stranicu 95)

DVGW Mješalica za kadu sa ugrađenim sigurnosnim sustavom (pogledaj stranicu 96)  Mješalica tuša (pogledaj stranicu 104, 106, 110, 124)

Mješalica za kadu (pogledaj stranicu 98, 102, 114, 116)  Ispust u kadu (pogledaj stranicu 102)

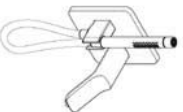

Termostat
(pogledaj stranicu 118, 122, 126)



High Flow Termostat
(pogledaj stranicu 128 - 138, 142,
144, 150 - 158)



Termostat sa izolacijskim ventilom
(pogledaj stranicu 104, 106, 110,
124)



Termostat sa ventilom za zatvaranje i
ventilom selektora
(pogledaj stranicu 98, 114, 116, 120)



High Flow Termostat sa izolacijskim
ventilom
(pogledaj stranicu 140, 146, 148)

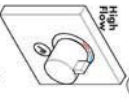

Termostat sa izolacijskim ventilom
(pogledaj stranicu 104, 106, 110)

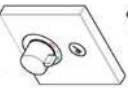

Termostat sa izolacijskim ventilom
(pogledaj stranicu 98, 114, 116, 120)

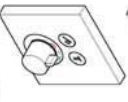

Termostat sa izolacijskim ventilom
(pogledaj stranicu 100, 112)



ShowerSelect Mješalica tuša
(pogledaj stranicu 104, 106, 110)

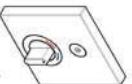

ShowerSelect Mješalica za kudu
(pogledaj stranicu 98, 114, 116, 120)

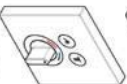

iControl
Ventil za zatvaranje i ventil selektora
(pogledaj stranicu 150)

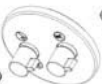

ShowerSelect
3 x zoporni ventil (pogledaj stranicu
144, 146 - 150, 158)

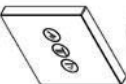

Raindance Showerpipe
(pogledaj stranicu 108)



Raindance Rainfall 240
(pogledaj stranicu 140, 142)



Raindance Rainfall 180
(pogledaj stranicu 154
- 158)



Raindance E 420
(pogledaj stranicu 150, 152) Raindance Select E 300
(pogledaj stranicu 148)

Ham montaj

iBox'un rotasyon simetrik ana gövdesi yatay veya dikey şekilde çok amaçlı kullanılabilir. İstisna: Emniyet kombinasyonu batarya armatürünün montajı sırasında sadece dikey montaj mümkündür. Fonksiyon parçalarının arızalanması durumunda iBox'tan su çıkabileceği için, dışarı çıkan suyun küveye akabilmesi için iBox küveyin üzerine monte edilmelidir.

iBox hem küveti hem de duş testisi için uygundur. Tek elle küveti tipi bataryalarda /Kesme ve diverter/ valfli termos-tatta otl çıkış önceliklidir. Duş testisinde, kullanılmıyolan çıkış bir tapuyla izole edilmelidir.

Sıcak ve soğuk su bağlantıları arasında büyük basınç farklılıklarına varsa, bu basınç farklılıklarının dengelemesi gerekir.

Ana gövdeyi, sıcak su bağlantısı solda ve soğuk su bağlantısı sağda olacak şekilde takın.

Montaj derinliği 80 mm ile 108 mm.

Uzatma 25 mm Ürün kodu 13595000

Uzatma 22 mm (montaj derinliği düşüktür)

Ürün kodu 13593000 / 13596XXX / 13597XXX / 15597000 / 19427000 / 97407XXX / 98860000

Ana gövde yapısal koşullara uygun şekilde takılabilir, Montaj örneği Bkz. Sayfa 91 ve 92.

A Duvara direkt montaj

B Duvara direkt montaj: Burada, esnek mesafe tutucuların ile 10'lü sıkma vidalarını kullanınlar.

C Tazyici sistem üzerine montaj.

D Hazır ev montaj plakaları ya da hazır hücrelere montaj.

E Tuğla duvar Montajı

F Montajı rayı seçiyse montajı #96615000.

Ölçü verileri ve hat boyutlandırıcı testisat örnekleri Sayfa 96 ile birlikte bulunabilir. Kullanılan simgelerin açıklaması Sayfa 57 ve 58'de.

Montaj kılavuzunda belirtilen montaj ölçüleri, yaklaşık 1.800 mm boyundaki kişiler için idealdir ve gerekirse adapte edilmelidir. Bu sırada, montaj yüksekliğinin değişmesiyle birlikte minimum yüksekliğin de değişimine ve bağlantı ölçülerindeki değişikliklerin göz önüne alınması gerektiğine dikkat edilmelidir.

Montaj önerisi

Bağlantı parçalarını vidalamak için, iBox'u bir boru parçasıyla menemeye sabitleyin.

Yıkama

Tüm testisat DIN 1988 / EN 1717'ye göre yıkayın. Yıkama blogundaki oklar hangi beslemenin hangi çıkış hattına bağlı olduğunu gösterir. Örn: soğuk su 1, çıkışa ve sıcak su 2. çıkışa. Sadece bir çıkış kullanılıyorsa, birinci yıkama işleminin sonra yıkama blogu 90° döndürülmelidir.

Çıkış ve taşıma aksesuarlı bir Exafill batarya girişiyse bağlantılı iBox (Bakınız sayfa 95)

Teknik bilgiler

İşleme basıncı:	özami 1 MPa
Tavsiye edilen işleme basıncı:	0,1 - 0,5 MPa
Kontrol basıncı:	1,6 MPa
(1 MPa = 10 bar = 147 PSI)	
Sıcak su sıcaklığı:	özami 80 °C
Tavsiye edilen su ısı:	65 °C
Bağlantı ölçüleri:	G ¾
Bağlantılar:	soğuk soğ - sıcak sol
0,3 MPa serbest akış:	31 l/dak // 24 l/dak
Küvet miks bataryası:	
Emniyetli kombinasyonlu küvet miks bataryası:	25 l/dak // 24 l/dak
Duş miks bataryası:	32 l/dak
Termostat:	43 l/dak
Kesme valfli termostat:	26 l/dak
Kesme ve diverter valfli termostat:	58 l/dak
Termostat High Flow:	58 l/dak
Control:	30 l/dak

Türkçe

X Küvetin ortası / Düş küvetinin ortası



Sivo alı valfi

Y Y – Hortum bağlantı kavşasının ortasından küvet girişinin ortası arasındaki ölçü 2'ye bölünür (gerekirse foyans bölümlerine odapne edin).



Quattro dört yollu değiştirme



Trio universal kapama ve değiştirme valfi

Sıcak su

Soğuk su



Trio

Küvet su girişi



Bu olanda duvarın kalınlaştırılması gereklidir.

Kullanimmayan çıkış bir kor topuyla izole edilmelidir. (DN 20 3/4")



Sadece bir tüketici mümkündür, aynı anda iki tüketici mümkün değildir.

Aşık kapasitesi 50 l/dak üzerinde olmamalıdır.



Yan duvarın su hatlarını eğimli şekilde döşeyin.



Aşık



Raindrain

Çıkış ve taşıma aksesuarlı bir Exafill batoryo girişiyile bağlantılılı Box (Bakınız sayfa 95)



Yıkama btoyu komple # 159,56000, Teslimat kapsamına dahil değildir.



Exafill

DVGW



Entegre emniyet kombinasyonlu küvet miks batoaryası (bakınız sayfa 96)



Düş miks batoaryası (bakınız sayfa 104, 106, 110, 124)



Küvet miks batoaryası (bakınız sayfa 98, 102, 114, 116)

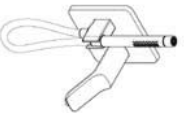

Küvet su girişi (bakınız sayfa 102)

Termostat
[bakınız sayfa 118, 122, 126]



High Flow Termostat
[bakınız sayfa 128 - 138, 142, 144,
150 - 158]



Kesme valfli termostat
[bakınız sayfa 104, 106, 110, 124]



Kesme ve divertör valfli termostat
[bakınız sayfa 98, 114, 116, 120]



High Flow Kesme valfli termostat
[bakınız sayfa 140, 146, 148]

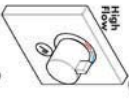

Kesme valfli termostat
[bakınız sayfa 104, 106, 110]

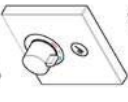

Kesme valfli termostat
[bakınız sayfa 98, 114, 116, 120]

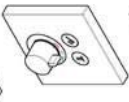

Kesme valfli termostat
[bakınız sayfa 100, 112]



Shower>Select Duş miks bataryası
[bakınız sayfa 104, 106, 110]



Shower>Select Küvet miks bataryası
[bakınız sayfa 98, 114, 116, 120]

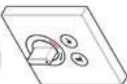

iControl
Kapatma ve değiştirme valfi [bakınız
sayfa 150]



Shower>Select
3 x Kesme valfi [bakınız sayfa 144,
146 - 150, 158]

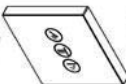

Raindance Showerpipe
[bakınız sayfa 108]



Raindance Rainfall 240
[bakınız sayfa 140, 142]



Raindance Rainfall 180
[bakınız sayfa 154 -
158]

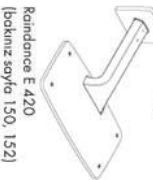

Raindance E 420
[bakınız sayfa 150, 152]

Raindance Select E 300
[bakınız sayfa 148]



Instalare bruia

Partea principală simetric-rotatojonă a iBox-ului poate fi introdusă oricum, atât orizontal cât și vertical. Excepție la montarea robinetului căzii cu combinația de protecție, în acest caz este posibilă numai montarea pe verticală. În cauza posibilității de defectare a componentelor din iBox, montați instalația iBox deasupra căzii pentru ca apa scursă să se evacueze prin cadă.

Cuția iBox este corespunzătoare atât pentru instalarea cadelor căi și a dusurilor. În cazul amestecătorului monomomental pentru cadă / termostat cu venil de închidere și valvă comutator, este prioritară ieșirea inferioară. La instalarea dusului, ieșirea netolosită trebuie etansată cu o garnitură de etansare.

Diferențele de presiune mari între alimentarea cu apă rece și apă caldă trebuie echilibrate.

Corpul de bază este astfel construit încât racordul pentru apa caldă se află în partea stângă, iar cel pentru apă rece, în dreapta.

Adâncime de montare 80 - 108 mm

Prelungitor 25 mm Nr. produs 13595000

Prelungitor 22 mm (în cazul montării la adâncime mică)

Nr. produs 13593000 / 13596XXX / 13597XXX / 15597000 / 19427000 / 97407XXX / 98860000

Corpul de bază se poate monta în funcție de condițiile existente, ca exemplu de montare, vedeți pagina 91 și 92.

A Montare pe perete.

B Montare pe perete. Cu distanțieri flexibili și file filetate de 10 mm cu diblu.

C Montare pe sistem de susținere.

D Montare pe plăci de montare prefabricate sau celule prefabricate.

E Montare direct pe perete.

F Montare cu set de șine de montare #96615000.

Exemple de montaj cu specificații referitoare la dimensiuni și procedură se găsesc începând de la pagina 96. Explicațiile simbolurilor utilizate se găsesc la pagina 60 și 61.

Dimensiunile de montare din instrucțiunile de montare sunt ideale pentru persoane cu o înălțime de cca. 1800 mm și trebuie modificate dacă este cazul. Aici trebuie să țineți cont de modificarea înălțimii de montare, deoarece în acest caz se va modifica și înălțimea minimă de montare și astfel trebuie modificate toate dimensiunile de racordare.

Indicații pentru montaj

Pentru înșurubarea piesei de racordare, cuția iBox este prevăzută cu o piesă tubulară strănsă în locașul filetat.

Clătire

Toată instalația se spală în conformitate prevederile DIN 1988 / EN 1717. Șegilele de pe blocul de spălare, arată cum se face racordarea la conducta de ieșire, spre apă rece cu ieșirea 1 și apă caldă cu ieșirea 2. În cazul în care este utilizată numai o ieșire, după prima spălare blocul de spălare trebuie rotit cu 90°.

Cuție iBox în combinație cu Exafill pe intrarea în cadă, cu un set pentru evacuare și deversare. (vezi pag. 95)

Date tehnice

Presiune de funcționare:	max. 1 MPa
Presiune de funcționare recomandată:	0,1 - 0,5 MPa
Presiune de verificare:	1,6 MPa
(1 MPa = 10 bar = 147 PSI)	
Temperatura apei calde:	max. 80°C
Temperatura recomandată a apei calde:	65°C
Interax racorduri:	G ¾
Racorduri:	rece - dreapta / cald - stânga
Debit cu curgere liberă la 0,3 MPa:	31 l/min // 24 l/min
baterie pentru cadă de baie:	25 l/min // 24 l/min
Baterie pentru cadă de baie cu combinație de siguranță integrată:	25 l/min // 24 l/min

Baterie dur:	32 l/min
Termostat:	43 l/min
Termostat cu venil de închidere:	26 l/min
Termostat cu venil de închidere și valvă comutator:	26 l/min

Termostat High Flow:	58 l/min
Control:	30 l/min

X Cădă de baie în mijloc / În mijlocul căzii de dus



Ventil montat sub tencuială

Y Dimensiune Y – distanța între mijlocul racordului pentru furcă și intrare cadă împărțită la doi (eventual potrivit la suprafața tencuiei!).



Quattro valvă de inversare cu patru căi

Apă caldă



Trio valvă de închidere și de inversare universală

Apă rece



Începând de la • funcționarea este garantată.



Gură de admisiune

În această zonă este nevoie de întărirea peretelui.



Racordurile neutilizate trebuie acoperite cu dop etanș. (DN 20 3/4")



Capacitatea de evacuare trebuie să fie mai mare de 50 l/min.

Montați conductele de apă inclinate (în cădere) pentru dușurile laterale.



Deversor



Compleți spălare #15956000, nu este inclus în setul livrat



Raindrain

Cutie IBox în combinație cu Exafill pe intrarea în cadă, cu un set pentru evacuare și deversare. (vezi pag. 95)

DVGW



Baterie pentru cadă de baie cu combinație de siguranță integrată (vezi pag. 96)



Baterie dis (vezi pag. 104, 106, 110, 124)



Baterie pentru cadă de baie (vezi pag. 98, 102, 114, 116)

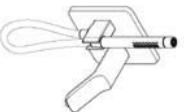

Gură de admisiune (vezi pag. 102)



Termostat
(vezi pag. 118, 122, 126)



High Flow Termostat
(vezi pag. 128 - 138, 142, 144,
150 - 158)



Termostat cu ventil de închidere
(vezi pag. 104, 106, 110, 124)



Termostat cu ventil de închidere și
valvă comutator
(vezi pag. 98, 114, 116, 120)

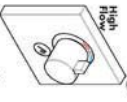

High Flow Termostat cu ventil de
închidere
(vezi pag. 140, 146, 148)



Termostat cu ventil de închidere
(vezi pag. 104, 106, 110)



Termostat cu ventil de închidere
(vezi pag. 98, 114, 116, 120)



Termostat cu ventil de închidere
(vezi pag. 100, 112)

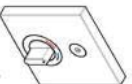

ShowerSelect Baterie dus
(vezi pag. 104, 106, 110)

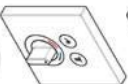

ShowerSelect baterie pentru cadd de
baie
(vezi pag. 98, 114, 116, 120)



iControl
Valvă de închidere și de inversare
(vezi pag. 150)

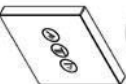

ShowerSelect
3 x Venili de închidere (vezi pag. 144,
146 - 150, 158)

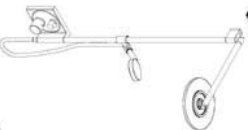

Raindance Showerpipe
(vezi pag. 108)



Raindance Rainfall 240
(vezi pag. 140, 142)



Raindance Rainfall 180
(vezi pag. 154 - 158)



Raindance E 420
(vezi pag. 150, 152)



Raindance Select E 300
(vezi pag. 148)

Εγκατάσταση

Το συμπιεστικό σώμα περιτορισφής του iBox μπορεί να χρησιμοποιηθεί παντού, οριζόντια και κατακόρυφα. Εξαιρέτως η συνδρομολόγηση της μηχανικής μονιάρας με συνδυασμό ασφαλείας, εδώ είναι έπικτη μόνο η κατακόρυφη εγκατάσταση. Σε περίπτωση βλάβης των λειτουργικών τμημάτων, μπορεί να εξερχεται νερό από το iBox, και θα πρέπει η μονάδα iBox να συνδρομολογηθεί πάνω από την μονιάδα, προκειμένου το εξερχόμενο νερό να πέσει μέσα στην μονιάδα στην περίπτωση αυτή.

Το iBox είναι κατάλληλο για εγκατάσταση τόσο σε μπανιέρες όσο και σε ντουζίτες. Σε αναμικτήρες μονιάρας με μία λαβή / θερμοστάτης με βαλβίδα έκτοισματος και εκτροπή, προτεινόμενο έχει η κάτω εξογνή. Σε εγκατάσταση σε ντουζίτες η εξογνή που δόν θα χρησιμοποιηθεί θα πρέπει να τοπώνεται με τόπο.

Οι διαφορές της πίεσης μεταξύ της σύνδεσης κρύου και ζεστού νερού θα πρέπει να αντισοδηζόνται.

Τοποθετήστε τη βασική εγκατάσταση έτσι ώστε η σύνδεση ζεστού νερού να βρίσκεται οριζοτάρα και του ψυχρού δάξια.

Βάθος τοποθέτησης 80 -108 mm.

Επιμήκυνση 25 mm αρ. τίδους 13595000

Σάλινος επιμήκυνσης 22 mm (σε μειωμένο βάθος τοποθέτησης)

αρ. τίδους 13593000 / 13596XXX / 13597XXX / 15597000 / 19427000 / 97407XXX / 98860000

Η βασική εγκατάσταση μπορεί να τοποθετηθεί σύμφωνα με τα δεδομένο του χάρου, ποσοδείγματα εγκατάστασης βλ.πίνα σάδα 91 και 92.

A. Επίτοιχη τοποθέτηση

B Επίτοιχη εγκατάσταση, Χρησιμοποίηστε 1Ώρες βίδες κορυφή με εύκαμπτο στηρήγισα.

C Συνδρομολόγηση επί κέροντος συστήματος.

D Εγκατάσταση σε προκατασκευασμένες συνδέες ή σε προκτ κεία.

E Εγκατάσταση απευθείας στον τοίχο

F Εγκατάσταση με σετ οδηγιοροχών συνδρομολόγησης #96615000.

Παροδείγματα εγκατάστασης με διαστάσεις και διαστατολόγηση των σωλήνων θα βρείτε από τη σάδα 96.

Επέξηγηση των Χρησιμοποιομένων εκονδίων θα βρείτε στη σάδα 63 και 64.

Οι διαστάσεις που αναφέρονται στις οδηγίες συνδρομολόγησης είναι ιδονικές για ότομα με ύψος περί 1800 mm και πρέπει, εάν Χρειοτάει, να προσαρμοστούν. Στη φάση αυτή προσεξτεί ότι με την αλλαγή του ύψους συνδρομολόγησης τροποποιείται και το αποτομένο λάξιστο ύψος, οπότε θα προκείνεται αλλαγή και στις διαστάσεις σύνδεσης.

Συμβουλή για την εγκατάσταση

Για να βιδώστε τρυπάνιο σύνδεσης, σφίξτε το iBox με ένα τρυπάνιο σωλήνη στη μέγγενη.

Καθαρισμός

Επιλύστε όλη την εγκατάσταση σύμφωνα με το DIN 1988 / EN 1717. Τα βίλα στο μπλοκ ζετάνυτος.

δείχνουν ποια ποροχή συνδέεται με ποιο σωλήνα εξέδου, π.χ. κρύο νερό με εξέδο 1 και ζεστό νερό με εξέδο 2.

Εάν χρειάζονται μόνο μια εξέδος, μετά την πρώτη διαδικασία ζετάνυτος, το μπλοκ ζετάνυτος πρέπει να γυρoται κατά 90°

iBox σε συνδυασμό με τίσοδο νερού μπανιέρας Exafill με αποροή και εξοπλισμό υπερχείλισης (βλ. σάδα 95)

Τεχνικά Χαρακτηριστικά

Λειτουργία πίεσης:	έως 1 MPa
Συντομωμένη λειτουργία πίεσης:	0,1 - 0,5 MPa
Πίεση αέχου:	1,6 MPa
(1 MPa = 10 bar = 147 PSI)	
Θερμοκρασία ζεστού νερού:	έως 80° C
Συντομωμένη θερμοκρασία ζεστού νερού:	65° C
Διαστάσεις σύνδεσης:	G ¾
Συνδέσεις:	κρύο δάξια - ζεστό οριζοτάρα
Εκείθρη ποή στα 0,3 MPa:	31 l/min // 24 l/min
Μητορία μονιάρας:	
Μητορία μονιάρας με ενσωματωμένο συνδυασμό ασφαλείας:	25 l/min // 24 l/min

Μητορία (μικτήρι) κατονομητορα: 32 l/min

Θερμοστάτης: 43 l/min

Θετμισοτάρας με βαλβίδα έκτοισματος: 26 l/min

Θετμισοτάρας με βαλβίδα έκτοισματος και εκτροπής: 26 l/min

Θετμισοτάρας High Flow:

iControl: 58 l/min
30 l/min

X

Κίτρινο μπινιέρως / Μίσον της βινιούρας



Χαμηλή βαλβίδα

Y

Μέγεθος X – από το μέσον του τμήου συνδέσεως του εύκαμπτου σωλήνα έως το μέσον της εισόδου της μπουνιέρως, δύο του 2 (απόδογμάνας να ηρίτρε να ηρροοορημοσέ σπο πόοοτηρ των ηηοοδώνω).



Quattro τριπόδοθης μετροπηής

Ζεστό νερό

Κρύο νερό



Trio Universal βαλβίδα ελεγχόμεας και εκρηπηής



Αυτή η λειτουργία διασφαλίζεται από το σήμαιο κι έστρεο



Εισοδος νερού στη μπουνιέρω



Σε αυτήν την προηοή είναι σπορητηη μία ενλοχωση του τοίχου.



Το ηρροπό σόμαιο έξοδου ηρίτρε να σρηγονοηοηόθων με ένα τυφλό ηάμμο. [DN 20 3/4"]



Μόνο ένας χρήσης, όχι δύο τουροτόχρηνα



Εγκροσσηοηε τους αγωνούδς νερού του καροιονηοήρηρα σόμαιορ με κλίση.



> 50 l/min

Βαλβίδα εκρηπηής



Raindrain

lBox σε συνδωσηομό με είσοδο νερού μπουνιέρως Exofill με σπορηοή και έξοδηομό υπρηκλήοηος [βλ. σάδηο 95]



Exofill

DVGW



Μηλοκ ζήτηλύμοηος κομηηέ #1.59.5.6.000, δεν ηηρηλοηόβωηεηαι σποηη ηηροδοηο

Μηπορηοηα μπουνιέρως με ενωμωηηρημέηω συνδωσηομό σσφάδαηος

[βλ. Σάδηο 96]



Μηπορηοηα (μικήηης) καροιονηοήρηρα [βλ. Σάδηο 104, 106, 110, 124]

Μηπορηοηα μπουνιέρως [βλ. Σάδηο 98, 102, 114, 116]

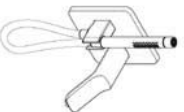

Είσοδος νερού στη μπουνιέρω [βλ. Σάδηο 102]



Θερμοστάτης
(βλ. Σελίδα 118, 122, 126)



High Flow Θερμοστάτης
(βλ. Σελίδα 128 - 138, 142, 144,
150 - 158)



Θερμοστάτης με βαλβίδα κλείσιματος
(βλ. Σελίδα 104, 106, 110, 124)



Θερμοστάτης με βαλβίδα κλείσιματος
και εστρωτής
(βλ. Σελίδα 98, 114, 116, 120)

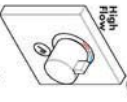

High Flow Θερμοστάτης με βαλβίδα
κλείσιματος
(βλ. Σελίδα 140, 146, 148)



Θερμοστάτης με βαλβίδα κλείσιματος
(βλ. Σελίδα 104, 106, 110)



Θερμοστάτης με βαλβίδα κλείσιματος
(βλ. Σελίδα 98, 114, 116, 120)



Θερμοστάτης με βαλβίδα κλείσιματος
(βλ. Σελίδα 100, 112)

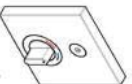

ShowerSelect Μπαρμπάκι (μετρική)
κατανομή
(βλ. Σελίδα 104, 106, 110)

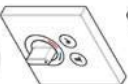

ShowerSelect Μπαρμπάκι μινιπέπας
(βλ. Σελίδα 98, 114, 116, 120)



iControl
Βαλβίδα κλείσιματος και εστρωτής (βλ.
Σελίδα 150)

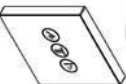

ShowerSelect
3 x Βαλβίδα κλείσιματος (βλ. Σελίδα
144, 146 - 150, 158)

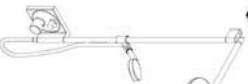

Raindance Showerpipe
(βλ. Σελίδα 108)



Raindance Rainfall 240
(βλ. Σελίδα 140, 142)

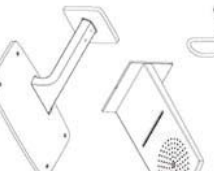

Raindance Rainfall 180
(βλ. Σελίδα 154 - 158)



Raindance E 420
(βλ. Σελίδα 150, 152)



Raindance Select E 300
(βλ. Σελίδα 148)

Surova montaža

Rolacijsko simetrično osnovno telo valja iBox je univerzalno uporabljivo, tako vodoravno kot tudi navpično. Izgledno je le montažo armature za kopalno kad z zaščitnim kompletom, kjer je možno le navpična vgradnja. Pri okvri delov iBoxa lahko pride do izteka vode, zato iBox montiramo nad kado. Tako lahko voda odteka v kadi.

iBox je primeren tako za instalacije za kopalne kadi kot tudi za prhe. Pri enotočnih baterijah za kopalno kad / termostatu z zapornim in preklonim ventilom ima prednost spodnji odvod. Pri instalaciji prhe je treba neuporablen odvod zatesniti s čepom.

Velike razlike v tlaku med priključkom za mrzlo in priključkom za toplo vodo je potrebno izravnati.

Osnovno telo vgradite tako, da se priključek za toplo vodo nahaja na levi, priključek za hladno vodo pa na desni strani.

Globina vgradnje 80 do 108 mm

Podaljšek 25 mm številka artikla 13595000

Podaljšek 22 mm (če zid ni dovolj globok)

Številka artikla 13593000 / 13596XXX / 13597XXX / 15597000 / 19427000 / 97407XXX / 988600000

Osnovno telo se lahko montira ustrezno gradbenim pogojem, montažne primere glejte na strani 91 in 92.

A Montaža na steno

B Montaža na steno. Tukaj z upogljivim distančnikom in 10-milimetrskimi vijaki.

C Montaža na nosilnem sistemu.

D Montaža na montažne plošče

E Montaža direktno v steno

F Montaža s pritrdilnim kompletom #96615000.

Instalacijske primere z navedbami mer in dimenzioniranja cevi najdete od strani 96 dalje. Razlage uporabljene simbolor na straneh 66 in 67.

V navodilu za montažo navedene mere so idealne za osebe, visoke pribl. 1800 mm, in jih je treba po potrebi prilagoditi. Pri tem morate pozni na to, da se pri spremeni montajni višini spremeni tudi minimalna višina in je treba upoštevati spremembo priključnih mer.

Nasvet za montažo

Za uvijte priključnih kosov iBox s pomočjo kosa cevi vrnite v primož.

Izpiranje

Kompletno instalacijo splaknite v skladu z DIN 1988 / EN 1717. Puščice na ventilu za vodo kažejo, kateri odvod je povezan s katerim odvodom, npr. mrzlo vodo z odvodom 1 in toplu vodo z odvodom 2. Če je potreben le en odvod, se mora po prvem splakovanju ventil za vodo obrniti za 90°.

iBox v kombinaciji z Exafill dovodom za kopalno kad z odtočno in pretočno garnituro (glejte stran 95)

Tehnični podatki

Delovni tlak:	maks. 1 MPa
Priporočeni delovni tlak:	0,1 - 0,5 MPa
Prekusni tlak:	1,6 MPa
(1 MPa = 10 bar = 147 PSI)	
Temperatura tople vode:	maks. 80 °C
Priporočena temperatura tople vode:	65 °C
Razdalja od sredine:	G ¾
Priključki:	mrzla desno - topla levo
Prosti pretok pri 0,3 MPa:	31 l/min // 24 l/min
Mešalna baterija za kadi:	
Mešalna baterija za kad z vgrajeno varnostno kombinacijo:	25 l/min // 24 l/min
Mešalna baterija za prho:	32 l/min
Termostat:	43 l/min
Termostat z zapornim ventilom:	26 l/min
Termostat z zapornim in preklonim ventilom:	26 l/min
Termostat High Flow:	58 l/min
iControl:	30 l/min

X

Sredina kopalne kadi / Sredina prišne kadi



Podometni ventili

Y

Mera Y – sredina loka priključka za cev do sredine dovoka v kadi deljeno z 2 (morebiti prilagoditi vzorcju ploščic)



Quattro utiripolna prestavitel



Topla voda

Trio Universal zoporni in preklopni ventili

Mrzla voda



Od • je delovanje zagotovljeno.

Viak v kadi



V tem območju je potrebno ojačanje stene.



Izhod, ki ga ne potrebujete, zatesnite s čepom. (DN 20 3/4")



Mogoč je samo en uporabnik, ne dva istočasno.



Odlična kaptelitamora znošati več kot 50 l/min.



Položite vodovodne cevi za stranske šobe z naklonom.



Raindrain

iBox v kombinaciji z Exatfill dovodom za kopalno kadi z odlično in preločno garnituro (glejte stran 95)



Ventil za vodo, kpl. #15956000, Ni vključeno



DVGW



Mešalna baterija za kadi z vgrajeno varnostno kombinacijo (glejte stran 96)



Mešalna baterija za prho (glejte stran 104, 106, 110, 124)



Mešalna baterija za kadi (glejte stran 98, 102, 114, 116)

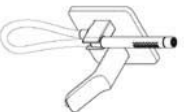

Viak v kadi (glejte stran 102)



Termostat
(glejte stran 118, 122, 126)



High Flow Termostat
(glejte stran 128 – 138, 142, 144,
150 - 158)



Termostat z zopornim ventilom
(glejte stran 104, 106, 110, 124)



Termostat z zopornim in preklopnim
ventilom
(glejte stran 98, 114, 116, 120)

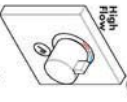

High Flow Termostat z zopornim
ventilom
(glejte stran 140, 146, 148)

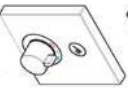

Termostat z zopornim ventilom
(glejte stran 104, 106, 110)

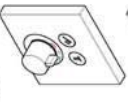

Termostat z zopornim ventilom
(glejte stran 98, 114, 116, 120)



Termostat z zopornim ventilom
(glejte stran 100, 112)

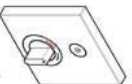

ShowerSelect Mešalna baterija za
prho
(glejte stran 104, 106, 110)

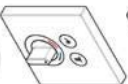

ShowerSelect Mešalna baterija za
kod
(glejte stran 98, 114, 116, 120)



iControl
Zoporni in preklopi ventil (glejte stran
150)

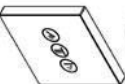

ShowerSelect
3 x Zoporni ventili (glejte stran 144,
146 - 150, 158)



Raindance Showerpipe
(glejte stran 108)



Raindance Rainfall 240
(glejte stran 140, 142)



Raindance Rainfall 180
(glejte stran 154 - 158)



Raindance Select E 300
(glejte stran 148)

Raindance E 420
(glejte stran 150, 152)

Toormontaaž

IBoxi summeerilise ringlusega põhikorpus on universaalselt kasutatav, nii horisontaalselt kui vertikaalselt. Va. turvakambraisooituga vannimatuuri paigaldamisel, kus on võimalik ainult vertikaalne paigaldamine. Paigaldage iBox alati vanni kohale. Kui iBox'i osad lähevad katki, võib vesi vanni voolata!

iBox sobib niihästi vanni kui ka duši paigaldamiseks. Ühetaevanimesegisti / katkestus- ja umberfüllusklapiiga termostaat puhul on alumine väljavool prioriteetne.

Duši paigaldamisel tuleb mittevajalik väljavool korgiga ihendada.

Kui külm ja kuum vee ühenduste surve on väga erinev, tuleb need tasakaalustada.

Põhikorpus paigaldada nii, et soola vee liitmik oleks vasakul ja külma vee liitmik paremal.

Paigalduse sügavus 80 mm kuni 108 mm

pikendus 25 mm artikli number 13595000

pikendus 22 mm [kui sein ei ole piisavalt paks].

artikli number 13593000 / 13596XXX / 13597XXX / 15597000 / 19427000 / 97407XXX / 98860000

Põhikorpus on võimalik paigaldada vastavalt ehituslikele nõuandele, näiteid paigaldamise kohta vt lk 91 ja 92.

A Seinale paigaldamine.

B Seinale paigaldamine. Siin reguleeritava vahahooldiku-ga, kasutades 10 mm rikkpöle.

C Kandurisüsteemile paigaldamine.

D Paigaldamine kiirmonooziplaatidele või valmisakabiini.

E Paigaldamine otse seinale.

F Paigaldamine kinnitussindidega #96615000.

Paigaldusnõuded koos mõõtude info ja voolikute suurus-tega leiate alates leheküljest 96. Kasutades sümbolite selgitsusel leiate lehekülgedel 69 ja 70.

Paigaldusjuhendis esitatud paigaldusmõõdud on ideaalsed u. 1800 mm pikkustele inimestele ning vajadusel tuleb neid kohandada. Seejuures tuleb silmas pidades, et muutunud paigalduskõrguse korral muutub ka minimaalne kõrgus ning tuleb arvestada, et erinevad on ka ühendusmõõdud.

Paigaldusnäpunäide

Ühendusdetailide sissekeeramiseks kinnitage iBox toru abil kruusistendisse.

Äravoolu süsteem

Pärast paigaldamist vastavalt standardile DIN 1988 / EN 1717 läbi pesti. Loputusploki olevad nooled näitavad, milline pealvool on millise äravoolumiruga seotud, ni külm vesi äravoolduga 1 ja soe vesi äravoolduga 2. Kui on vaja ainult ühte äravoolu, tuleb loputusplokki pärast esimest loputust 90° keerata.

iBox ühenduses ära- ja ülevoolugarnituuriga Exafilli vanni sisesevooluga (vt lk 95)

Tehnilised andmed

Töörõhk	maks. 1 MPa
Soovitatav töö rõhk:	0,1 - 0,5 MPa
Kontrollsurve:	1,6 MPa
(1 MPa = 10 baari = 147 PSI)	
Kuum vee temperatuur:	maks. 80 °C
Soovitatav kuum vee temperatuur:	65 °C
distantis kehteli:	G ¾
ühendused:	külm poremol, kuum vasakul
Äravoolu surve 0,3 MPa	31 l/min // 24 l/min
Vanni-duši segisti:	25 l/min // 24 l/min
Turvosüsteemiga vanni-duši segisti:	32 l/min
dušisegisti:	43 l/min
Termostaat:	26 l/min
Katkestusklapiiga termostaat:	26 l/min
Katkestus- ja umberfüllusklapiiga termostaat:	58 l/min
Termostaat High Flow:	30 l/min
iControl:	

X

Vanni keskkoht / Dusivanni keese



petieklopp

Y

Mõeti Y – vooliku seinaväljavoolu keskmesest vannitühri keskele jagatud 2-ga (võimalusel kohandage keramiiliste pliitide asetusega).



Quattro-liimik



Soe vesi

Kaakestus- ja ümberlüüsklopp Trio Universal

Külm vesi



Trio

Vanni kroon



Alates • on funktsioneerimine garanteeritud



Mittetavalik väljavool tuleb sulgeda korgiga. (DN 20 3/4")



Võimalik on ainult üks funktsioon, mitte kaks korraga.



Ärvoolu jõudlus peab olema suurem kui 50 l/min.



Ärvool



Paigaldage kehitudüsi jooks vajalikud veetorud kaldlega.



Raindrain

iBox ühenduses ära- ja ülevoolugarnituuriga Exafilli vanni sissevooluga (vt lk 95)



Exafill

DVGW



Turvasüsteemiga vannidüsi segisüsi (vt lk 96)



düsi segisüsi (vt lk 104, 106, 110, 124)



Vannidüsi segisüsi (vt lk 98, 102, 114, 116)

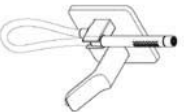

Vanni kroon (vt lk 102)

Termostaat
[vt lk 118, 122, 126]



High Flow Termostaat
[vt lk 128 - 138, 142, 144, 150-158]



Kaitestusklappiga termostaat
[vt lk 104, 106, 110, 124]



Kaitestus- ja ümberlükkklappiga termostaat
[vt lk 98, 114, 116, 120]



High Flow Kaitestusklappiga termostaat
[vt lk 140, 146, 148]

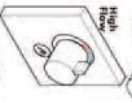

Kaitestusklappiga termostaat
[vt lk 104, 106, 110]

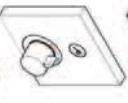

Kaitestusklappiga termostaat
[vt lk 98, 114, 116, 120]

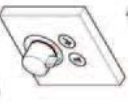

Kaitestusklappiga termostaat
[vt lk 100, 112]



ShowerSelect dušisegisti
[vt lk 104, 106, 110]

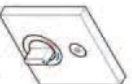

ShowerSelect Vanni-duši segisti
[vt lk 98, 114, 116, 120]



iControl
Kaitestus- ja ümberlükkklapp [vt lk 150]



ShowerSelect
3 x võkustus klapp [vt lk 144, 146-150, 158]

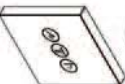

Raindance Showerpipe
[vt lk 108]



Raindance Rainfall 240
[vt lk 140, 142]



Raindance Rainfall 180
[vt lk 154 - 158]

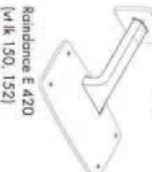

Raindance E 420
[vt lk 150, 152]



Raindance Select E 300
[vt lk 148]

Cauruļu montāža

Rokācija sīmeiriskais iBox korpusu ir izmantojams universālā - li - gan horizontāli, gan vertikāli. Izņemot godījumus, kad veic vannas armatūras montāžu ar drošības kombināciju -žādos godījums iespējama tikai vertikālo iebūve. Tā kā funkcionālo detaļu bojājumu riski vertikālo iebūvē, un izplūst ūdens, iBox jāmontē virs vannas, lai izplūstošais ūdens varētu noliekt vannā!

iBox ir piemērots gan vannu, gan dušu instalācijām. Vannas jaucekļrāņiem ar vienu / Termosists ar noslēgtvārstu un pārslēdzējvārstu, rokturi apakšējai izplūdei ir prioritāte, lai palīdzētu dušu, nevojadzīgā izplūde jānobīvē ar atzāzni.

Jāizdiena spiediena atšķirības starp aukstā un karstā ūdens pievadiem.

Korpusu iebūvējiet tā, lai silta ūdens pieslēgums atstātos pa kreisi un aukstā ūdens pieslēgums - pa labi.

Iebūvēšanas dziļums 80 mm (līdz 108 mm.

Pogardinājus 25 mm artikla numurs 13595000

Pogardinājus 22 mm (ja iebūvēšanas dziļums nav pietiekams)

artikla numurs 13593000 / 13596XXX / 13597XXX / 15597000 / 19427000 / 97407XXX / 98860000

Korpusu iespējams iebūvēt atbilstoši konstrukcijas īpašībām, montāžas piemērus skat. 91. un 92. lpp.

A Instalācija pie sienas.

B Instalācija pie sienas. Šeit ar elastīgu starpliku un 10 mm izmēro montāžas skrūvēm.

C Montaža uz balstu sistēmu.

D Instalācija uz gataviem montāžas paneļiem vai gataviem elementiem.

E Instalācija tieši sienā.

F Instalācija ar montāžas sliedžu komplektu #96615000.

Uzstādīšanas piemēri ar izņemtiem un vadu izkārtojumu atrodami sākot no 96.lappuses. Lietotā simbolu izskaidrojums atrodams 72 un 73.lappusē.

Montāžas instrukcijās dotie montāžas izmēri ir ideāli piemēroti personām, kuru augums ir apm. 1800 mm.

Nepieciešamības gadījumā šie izmēri ir jāpielāgo. Šeit ir ņemti vērā, ka mainoties montāžas augstumam, mainās arī minimālais augstums, un jāņem vērā arī pieslēgšanas izmēru izmaiņas.

Montāžas padoms

Lai iegriestu savienojuma elementus, iBox ar caurules palīdzību nostipriniet skrūvspīles.

Skalošana

Izskalojiet visu instalāciju atbilstoši DIN 1988 / EN 1717. Bulļiens uz skalošanas bloka porādo, kurš pievada ir savienots ar atliecīgo izplūdes cauruli, piem., aukstais ūdens ar 1. izplūdi un siltais ūdens ar 2. izplūdi. Ja nepieciešama tikai viena izplūde, pēc pirmas skalošanas režises por 90° jāpogrīnē skalošanas bloks.

iBox kombinācijā ar Exafill vannas ietilpdi ar noplūdes un pārplūdes garnitūru (skat. 95. lpp.)

Tehniskie dati

Darbo spiediens:	maks. 1 MPa
Ieteicamais darbo spiediens:	0,1 - 0,5 MPa
Pārbaudes spiediens:	1,6 MPa
(1 MPa = 10 bar = 147 PSI)	
Karstā ūdens temperatūra:	maks. 80 °C
Ieteicamā karstā ūdens temperatūra:	65 °C
Pieslēguma izmēri:	G ¾
Pieslēgumi:	aukstais pa labi - karstais pa kreisi
Brīva caurplūde, ja ir 0,3 MPa:	31 l/min // 24 l/min
Vannas/ dušas jaucekļrāns:	
nāciju:	25 l/min // 24 l/min
Dušas jaucekļrāns:	32 l/min
Termosists:	43 l/min
Termosists ar slēgvārstu:	26 l/min
Termosists ar noslēgvārstu un pārslēdzējvārstu.:	26 l/min
Termosists High Flow:	58 l/min
iControl:	30 l/min

X

Vannas vidus / Dušas paliktno vidus



Zemopmetuma ventilis

Y

Izmērs Y – šūļenes savienojuma loka vidū līdz vannas ietecece vidum daļi ar 2 (eventuāli piemēroti filīzu rakstam)



Četrvirzienu pārslēgls

Siltais ūdens



Quattro

Trisvirzienu universālais noslēgvārsts un pārslēdzējvārsts

Aukstais ūdens



Trio

No • funkcija nodrošināta

Vannas tekne



Neizmantolo izteku aizbāzī ar aizbāzni. (DN 20 3/4")



Šajā zonā ir nepieciešams pastiprināti sienu.

Noieces veiktspēja jābūt vairāk nekā 50 l/min.



Montēt ūdens cauruļvadus sānu (ķermeņa) dušām ar atbilstošu slīpumu.

Noiece



Skatīšanas bloks, kompl. # 159256000, komplekta netiek piegādāts



Raindrain



Exatfill

iBox kombinācija ar Exatfill vannas iepļūdi or noplūdes un pārplūdes garnitūru (skat. 95. lpp.)

DVGW



Vannas/ dušas jaucekļkrāns ar integrētu drošības kombināciju (skat. lpp. 96)



Dušas jaucekļkrāns (skat. lpp. 104, 106, 110, 124)



Vannas/ dušas jaucekļkrāns (skat. lpp. 98, 102, 114, 116)

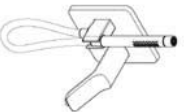

Vannas tekne (skat. lpp. 102)

Termostats
(skat. lpp. 118, 122, 126)



High Flow Termostats
(skat. lpp. 128 - 138, 142, 144, 150 - 158)



Termostats ar slēgvārstu.
(skat. lpp. 104, 106, 110, 124)



Termostats ar noslēgvārstu un pārslēdzējvārstu.
(skat. lpp. 98, 114, 116, 120)



High Flow Termostats ar slēgvārstu.
(skat. lpp. 140, 146, 148)

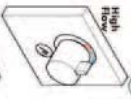

Termostats ar slēgvārstu.
(skat. lpp. 104, 106, 110)



Termostats ar slēgvārstu.
(skat. lpp. 98, 114, 116, 120)

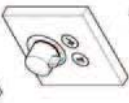

Termostats ar slēgvārstu.
(skat. lpp. 100, 112)



ShowrSelect Dušas ļaucekļkams
(skat. lpp. 104, 106, 110)

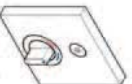

ShowrSelect Vannas/ dušas ļaucekļkams
(skat. lpp. 98, 114, 116, 120)



iControl
Noslēgvārstis un pārslēdzējvārstis (skat. lpp. 150)



ShowrSelect
3 x Slēgvārstis (skat. lpp. 144, 146 - 150, 158)

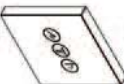

Raindance Showerpipe
(skat. lpp. 108)



Raindance Rainfall 240
(skat. lpp. 140, 142)



Raindance Rainfall 180
(skat. lpp. 154 - 158)

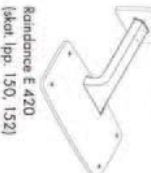

Raindance Select E 300
(skat. lpp. 148)



Priprema montaže

Rotaciono simetrično telo jedinice iBox je univerzalno primenljivo, kako horizontalno tako i vertikalno. Izuzetak predstavlja montaža armatura za kade sa sigurnosnom kombinacijom, jer tu mogući samo vertikalna ugradnja. Pošto kod kvara pojedinih delova iz iBox-a može isticati voda, iBox se mora instalirati iznad kade, tako da voda može isticati u kadu!

iBox je pogodan za ugradnju na tuš i instalaciju za kade. Kod jednoručnih mešača za kadu / termostata s ventilom za zatvaranje i preklopnim ventilom prioritetan je donji izlaz. Kod instalacije na tuš izlaz koji se ne upotrebljava mora da se zatvori čepom.

Velika razlika u pritisku između vruće i hladne vode mora biti izbalansirana.

Montirajte telo tako da priključak tople vode bude sa leve, a hladne sa desne strane.

Dubina ugradnje 80 - 108 mm.

Produžetak 25 mm br. Proizvoda 13595000

Produžetak 22 mm (kod manje dubine ugradnje)

br. Proizvoda 13593000 / 13596XXX / 13597XXX / 15597000 / 19427000 / 97407XXX / 988600000

Telo može da se montira u skladu sa uslovima na mestu ugradnje, za primere montaže vidi strane 91 i 92.

- A** Direktna instalacija na zid.
- B** Direktna instalacija na zid s držačem odstojanja pomoću 10 mm podesevih zavrtnjača.
- C** Montaža na sistem nosača.
- D** Instalacija na gotove montažne ploče ili gotove ćelije.
- E** Instalacija direktno u zid.
- F** Instalacija sa setom instalacionih šina #96615000.

Primeri instalacije sa veličinama i dimenzijama vodova mogu se naći od stranice 96 nadalje. Ojačanje korišćenih simbola nalazi se na stranici 75 i 76.

Montažne dimenzije navedene u uputstvu za montažu idelone su za osobe visine oko 1800 mm, tako da se po potrebi moraju prilagoditi konkretnoj visini korisnika. Pri tome treba uzeti u obzir da se prilikom promene montažne visine menja i minimalna visina kao i da se u tom slučaju mora uzvati i promena priključnih dimenzija.

Savet u vezi montaže

Za uvrtnje priključnih elemenata iBox treba zategnuti u stepu uz pomoć komada cevi.

Ispiranje

Kompletnu instalaciju treba ispirati u skladu sa normom DIN 1988 / EN 1717. Strelice na bloku prikazuju koji je dovod spojen sa kojim odvodom, npr. hladna voda sa odvodom 1, a topla voda sa odvodom 2. Ukoliko je potreban samo jedan odvod, onda se nakon prvog ispiranja blok mora zakrenuti za 90°.

iBox u kombinaciji sa Exafill dotokom kade sa odvodnom i prelivnom garniturom (vidi stranu 95)

Tehnički podaci

Radni pritisak:	maks. 1 MPa
Preporučeni radni pritisak:	0,1 - 0,5 MPa
Probi pritisak:	1,6 MPa
(1 MPa = 10 bar = 147 PSI)	
Temperatura vode:	maks. 80 °C
Preporučena temperatura vruće vode:	65 °C
Rastojanje između centara priključaka:	G ¾
Priključci:	hladna voda desno - topla leva
Slobodan protok na 0,3 MPa:	31 l/min // 24 l/min
Mešač za kadu:	
Mešač za kadu s ugrađenim sigurnosnim sistemom:	25 l/min // 24 l/min
Mešač tuša:	32 l/min
Termostat:	43 l/min
Termostat s ventilom za zatvaranje:	26 l/min
Termostat s ventilom za zatvaranje i preklopnim ventilom:	
26 l/min	
Termostat High Flow:	58 l/min
iControl:	30 l/min

X

Sredina kade / Sredina tuš-kada



Uzdni ventil

Y

Mera Y – sredina priključnog luka ceva do sredine donjaka kade podeljeno sa 2 (eventualno prilagoditi rasteru pločica).



Quattro četvorostruki preusmerivač



Topla voda

Hladna voda

Od • je funkcija zagarantovana.

U ovoj oblasti je potrebno ojačanje zida.

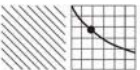

Moguće je koristiti samo jedan potrošač, nikako dva istovremeno!

Položite vodovodne cevi za bočni tuš s nagibom.



kompletna blok #15956000, Nije sadržano u isporuci



DVGW

Mešač za kadu s ugrađenim sigurnosnim sistemom (vidi stranu 96)



Mešač za kadu (vidi stranu 98, 102, 114, 116)



Quattro

Trio Universal ventil za zatvaranje i preklopni ventil



Trio

Dotok kade



Izlaz koji se ne koristi, mora se zatvoriti stepim čepom. (DN 20 3/4")



Kapacitet odvoda mora biti veći od 50 l/min.



> 50 l/min

Ispust



Raindrain



iBox u kombinaciji sa Exafill dotokom kade sa odvodnom i prelivnom garnitrom (vidi stranu 95)

Exafill

Mešač tuša (vidi stranu 104, 106, 110, 124)



Dotok kade (vidi stranu 102)

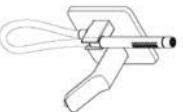



Termostat
(vidi stranu 118, 122, 126)



High Flow Termostat
(vidi stranu 128 – 138, 142, 144,
150 - 158)



Termostat s ventilom za zatvaranje
(vidi stranu 104, 106, 110, 124)



Termostat s ventilom za zatvaranje i
preklapnim ventilom
(vidi stranu 98, 114, 116, 120)

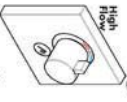

High Flow Termostat s ventilom za
zatvaranje
(vidi stranu 140, 146, 148)

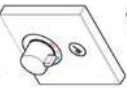

Termostat s ventilom za zatvaranje
(vidi stranu 104, 106, 110)

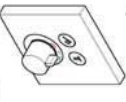

Termostat s ventilom za zatvaranje
(vidi stranu 98, 114, 116, 120)



Termostat s ventilom za zatvaranje
(vidi stranu 100, 112)



ShowerSelect Mešač tuša
(vidi stranu 104, 106, 110)

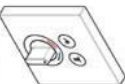

ShowerSelect Mešač za kudu
(vidi stranu 98, 114, 116, 120)



iControl
Venil za zatvaranje i preklapni venil
(vidi stranu 150)

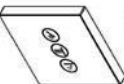

ShowerSelect
3 x Venil za zatvaranje (vidi stranu
144, 146 - 150, 158)

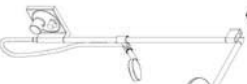

Raindance Showerpipe
(vidi stranu 108)



Raindance Rainfall 240
(vidi stranu 140, 142)



Raindance Rainfall 180
(vidi stranu 154 - 158)



Raindance E 420
(vidi stranu 150, 152)



Raindance Select E 300
(vidi stranu 148)

Råmontasje

Det rotasjonsymmetriske baseelementet til Box kan brukes universelt dvs. horisontalt og vertikalt. Et unntak er ved montasje av kararmatur med sikkerhetskombinasjon. Da er det kun mulig med vertikal montasje. Etersom det kan lette vann ut av Boxen ved en defekt, skal Boxen monteres over badekaret, slik at vannet som lekker ut kan renne ned i badekaret.

Boxen egner seg både for installasjon på dusj eller badekar. Ved enhåndblandebatteri for badekar / termostat med sperre- og omslingingsventil prioriteres nedre utgangen. Ved installasjon i dusjen skal utgangen som ikke brukes tettes med en plugg.

Store trykkdifferanser mellom kaldt- og varmvannstilkoblinger skal utlignes.

Baseelementet bygges inn slik at varmvannstilkobling er på venstre og kaldvannstilkobling er på høyre side.

Innbyggingsdybde 80 mm til 108 mm.

Førlengelse 25 mm Artikkelnummer 13595000

Førlengelse 22 mm (ved liten montasje dybde)

Artikkelnummer 13593000 / 13596XXX / 13597XXX / 15597000 / 19427000 / 97407XXX / 98860000

Baseelementet kan monteres iht. byggmessige forhold, se montasje-eksempel på side 91 og 92.

- A** Installasjon på vegg
- B** Installasjon på vegg. Her med fleksible avstandsholdere via spesialskruter.
- C** Montasje på bæresystem.
- D** Installasjon på ferdighusmontasjeplater eller prefabrikkert celler.
- E** Installasjon rett på vegg.
- F** Installasjon med sett av montasjeskinner #96615000.

Installasjonseksempel med målangivelser og ledningsdimensjoner finns fom. side 96. Forklaring for brukte symboler på side 78 og 79.

Monteringsmål i monteringsveiledningen er beregnet for personer som er omtrent 1800 mm høyre, målene skal eventuelt tilpasses om nødvendig. Her skal man passe på at ved endrede monteringsmålene blir minste høyden endret, og det må tas hensyn til de endrede tilkoblingsmålene.

Montasje-tipp

For å skru inn koblinger skal Boxen settes fast i en skru-sikke ved hjelp av et rør.









Spyle

Komplett installasjon spyles iht. DIN 1988 / EN 1717. På lene på spyleblokken indikerer hvilke tilsløp som er koblet sammen med hvilken utgangsledning, f.eks. kaldvann med utgang 1 og varmvann med utgang 2. Hvis det kun er nødvendig med en utgang, skal spyleblokken dreies med 90° etter den første spylingen.

IBox i kombinasjon med Exfill karinløp med avløps- og overflytgarnityr (se side 95)

Tekniske data

Driftstrykk	maks. 1 MPa
Anbefalt driftstrykk:	0,1 - 0,5 MPa
Prøvetrykk	1,6 MPa
(1 MPa = 10 bar = 147 PSI)	
Varmvannstemperatur	maks. 80 °C
Anbefalt temperatur for varmt vann	65 °C
Tilkoblingsmål:	G ¾
Tilkoblinger:	kaldt høyre - varmt venstre
Fri gjennomsstrøming ved 0,3 MPa:	31 l/min // 24 l/min
Blondbatteri for badekar:	31 l/min // 24 l/min
Blondbatteri for badekar med integrert sikkerhetskombinasjon:	25 l/min // 24 l/min
Dusj-blandebatteri:	32 l/min
Termostat:	43 l/min
Termostat med sperreventil:	26 l/min
Termostat med sperre- og omslingingsventil:	26 l/min
Termostat High Flow:	58 l/min
iControl:	30 l/min

<p>X Midten av badekaret / Midten på dusjkar</p>	 <p>Innfelt ventil</p>
<p>Y Mål Y = Midten til slangekobleingsbue (o.m. badekarinnløp deli på 2 (eventuelt skal filteraster tilpasses)).</p>	 <p>Quattro fire-veis omsjilling</p>
<p>Varmtvann</p> <p>Kaldtvann</p>	 <p>Trio</p> <p>Trio universal stenge- og omsjillingsventil</p>
<p>F.o.m. • er funksjonen garantert</p>	 <p>Innløp badekar</p>
<p>I dette området skal veggjen forsterkes.</p>	 <p>Utgangen som ikke brukes kan testes med en blindplugg. (DN 20 3/4")</p>
<p>Kun en forbruker mulig, ikke to samtidig.</p>	 <p>Avløp yrelse skal være mer enn 50 l/min.</p>
<p>Vannledninger for sidedusjer installeres med fall.</p>	 <p>Avløp</p>
 <p>Spyleblokk kpl. #15956000, ikke med i leveransen</p>	 <p>Raindrain</p> <p>iBox i kombinasjon med Exfill korrinløp med avløps- og overflygarnityr (se side 95)</p>

DVGW



Blandebatteri for badekar med integrert sikkerhetskombinasjon (se side 96)



Blandebatteri for badekar (se side 98, 102, 114, 116)



Dusjblandebatteri (se side 104, 106, 110, 124)

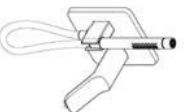

Innløp badekar (se side 102)



Termostat
(se side 118, 122, 126)



High Flow Termostat
(se side 128 - 138, 142, 144, 150 - 158)



Termostat med sperreventil
(se side 104, 106, 110, 124)



Termostat med sperre- og omslingsventil
(se side 98, 114, 116, 120)

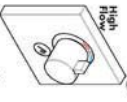

High Flow Termostat med sperreventil
(se side 140, 146, 148)

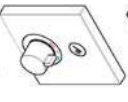

Termostat med sperreventil
(se side 104, 106, 110)

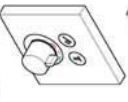

Termostat med sperreventil
(se side 98, 114, 116, 120)



Termostat med sperreventil
(se side 100, 112)

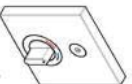

ShowerSelect Dug-bløddbatteri
(se side 104, 106, 110)

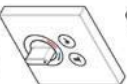

ShowerSelect Bløddbatteri for badekar
(se side 98, 114, 116, 120)

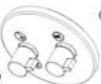

iControl
Slenge- og omslingsventil (se side 150)

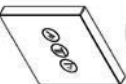

ShowerSelect
3 x Sperreventil (se side 144, 146 - 150, 158)

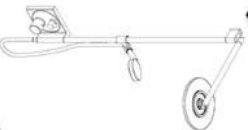

Raindance Showerpipe
(se side 108)



Raindance Rainfall 240
(se side 140, 142)

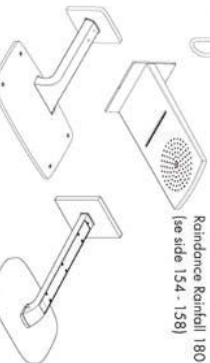

Raindance Rainfall 180
(se side 154 - 158)

Raindance E 420
(se side 150, 152)

Raindance Select E 300
(se side 148)

Първичен монтаж

Ротационно-симетричното основно тяло на iBox може да се приложи универсално, хоризонтално и вертикално. Изключение прави монтажът на арматурата за ванна с комплект предизтигтели, тук е възможен само вертикален монтаж. Тък като при дефект на функциониранияте части около iBox може да изтече вода, iBox трябва да се монтира над ваната, за да може изтичащата вода да се отича във ваната!

iBox е подходящо както за инсталации на ванни, така и за душове. При смесители за ванна с едно ръкохватка / термостат със спирателен и превключващ клапан първоначален е долният извод. При инсталация на разпръсквателен илищният извод трябва да се улътни с тухла пробка.

Горемите розетки в налягането между изводите за студентата и топлата вода трябва да се изравняват.

Основното тяло се монтира така, че изводът за топла вода да се намира отвъд, а за студена вода отвъсно. Монтажно дълбочина 80 мм до 108 мм.

Удължител 25 мм Номенклатурен номер 13595000
Удължител 22 мм (при малка монтажна дълбочина)
Номенклатурен номер 13593000 / 13596XXX /
13597XXX / 15597000 / 19427000 / 97407XXX /
98860000

Основното тяло може да се закрепят на стената в съответствие с конструктивните долености, примери за монтаж на стр. 91 и 92.

A Инсталация на стената.

B Инсталация на стената. Тук с павкова розетка с помощта на комбинирани болгове 10.

C Монтаж на третерната система.

D Инсталация върху монтажни плочи на спобявими стрази или готови клетки.

E Инсталация директно в стената.

F Инсталация с набор монтажни шини #96615000.

Примери за инсталация с данни за размери и опре- делене на размерите на тръбопровода може да намерите от стр. 96 нататък. Различения на изпозда- ните символи на стр. 81 и 82.

Посочените в ръководството за монтаж монтажни мерки са дадени за лица с ръст от прикл. 1800 мм и трябва съответно да се приполад. При това обръчате внимание на това, при променен монтаж височина се променя минималното височина и трябва да бъде взето под внимание промяната на присъединителните размери.

Съвети при монтаж

За да завинтите присъединителните елементи затегне- те iBox с помощта на грабчен елемент в менюта.

Промиване

Промийте цялото инсталация съгласно DIN 1988 / EN 1717. Стрелките на промиващия блок показват, кой вход с кой изходът тръбопровода е свързан, напр. студена вода с извод 1, а топла вода с извод 2. В случай, че е необходим само един изход, след първия процес на промиване промиващият блок трябва да се завърти на 90°.

**iBox в комбинация с вход за ванна
ExaFill с гарнитура за изтичане и пре-
ливане.** (вижте стр. 95)

Технически данни

Работно налягане:	макс. 1 MPa
Препоръчително работно налягане:	0,1 - 0,5 MPa
Контролно налягане:	1,6 MPa
(1 MPa = 10 bar = 147 PSI)	
Температура на горещата вода:	макс. 80°C
Препоръчителна температура на горещата вода:	65°C
Присъединителни размери:	G ¾
Изводи:	студено отвъдно – топло отвъдно
Свободен поток при 0,3 MPa:	31 л/мин // 24 л/мин
Смесител за ванна:	
Смесител на ванна с интегриран комплект предпази- телни:	
	25 л/мин // 24 л/мин
Смесител на разпръсквател:	32 л/мин
Термостат:	43 л/мин
Термостат със спирателен клапан:	26 л/мин
Термостат със спирателен и превключващ клапан:	26 л/мин
Термостат High Flow:	58 л/мин
iControl:	30 л/мин

X Средо на ваната / Средо на коритото на душ-кабината



Клатон за мозилка

Y

Марка Y – Средо на присъединителното коляно на морчуца до входа на ваната разделено на 2 (авентурално изравнене към ролстери на плочките).



Quattro

Четиритътно превключващо Quattro

Топла вода



Trio

Спирателен и превключващ клапан Trio Universal

Студена вода

От • функцията е гарантирана.

Вход за ванна



В тази област е необходимо подсилване на стената.



Изпишният извод може да се уплътни с глуха пробка. (DN 20 3/4")



Възможен е само един консулатор, не два едновременно.



Мощността на изтичане трябва да бъде повече от 50 л/мин.



Водопроводните линии за страничните разпръскатели полагайте с наклон.



Raindrain

!Box в комбинация с вход за ванна Exhill с горнитурата за изтичане и преливане. (вижте стр. 95)



DUSH



Смесител на ванна с интегриран комплект предпазителни (вижте стр. 96)



Смесител на разпръскаателя (вижте стр. 104, 106, 110, 124)



Смесител за ванна (вижте стр. 98, 102, 114, 116)

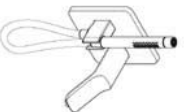

Вход за ванна (вижте стр. 102)



Термостат
(вижте стр. 118, 122, 126)



High Flow Термостат
(вижте стр. 128 – 138, 142, 144,
150 - 158)



Термостат със спирателен клапан
(вижте стр. 104, 106, 110, 124)



Термостат със спирателен и прена-
ключващ клапан
(вижте стр. 98, 114, 116, 120)

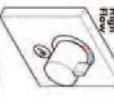

High Flow Термостат със спирателен
клапан
(вижте стр. 140, 146, 148)

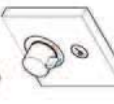

Термостат със спирателен клапан
(вижте стр. 104, 106, 110)

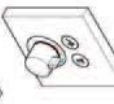

Термостат със спирателен клапан
(вижте стр. 98, 114, 116, 120)



Термостат със спирателен клапан
(вижте стр. 100, 112)

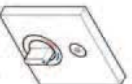

ShowerSelect Смесител на разляжък-
ватаи
(вижте стр. 104, 106, 110)



ShowerSelect Смесител за вана
(вижте стр. 98, 114, 116, 120)



Control
Спирателен и преключващ клапан
(вижте стр. 150)

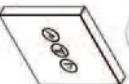

ShowerSelect
3 x Спирателен клапан (вижте стр.
144, 146 - 150, 158)



Raindance Showerpre
(вижте стр. 108)



Raindance Rainfall 240
(вижте стр. 140, 142)



Raindance Rainfall 180
(вижте стр. 154 - 158)



Raindance E 420
(вижте стр. 150, 152)



Raindance Select E 300
(вижте стр. 148)

Montimi në vija të trasha

Tripi bazë me rotacion simetrik i iBox-i mund të përdoret në mënyrë universale, si horizontalisht, ashtu edhe vertikalisht. Me përfundim të montimit të armatutës së vaskës me kombinim me elemente sigurie. Kështu është i mundur vetëm montimi vertikal. Meqë në rast të ndonjë defekti të pjesëve funksionale mund të rriqdhë uji nga iBox-i, është e nevojshme që iBox-i të montohet sipër vaskës, me qëllim që uji që rriqdh të derdhet në vaskë! iBox-i është i përshatshëm si për instalimin me vaskën, ashtu edhe me dushin. Te rubinetet me një dorëzë për përzierjen e ujit për vaskën / termostati me ventil bllokues dhe ventil për ndërrimin e pozicionit ka prioritet dalje e poshtme. Në rast se instalohet dushi, atëherë dalje që nuk nevojitet duhet mbyllur me një tapë. Ndryshimet e mëdha të presionit mes lidhjeve të ujit të ftohje dhe uji të ngrohtë duhen ekuilibruar.

Tripi bazë duhet montuar në atë mënyrë që lidhja e ujit të ngrohtë të jetë në të majtë dhe ajo e ujit të ftohje në të djathtë.

Thellessia e montimit 80 mm deri 108 mm.

Zgjatësi 25 mm Numri i artikullit 13595000

Zgjatësi 22 mm (Iartësia e montimit jo e madhe)

Numri i artikullit 13593000 / 13596XXX / 13597XXX / 15597000 / 19427000 / 97407XXX / 98860000

Tripi bazë mund të montohet duke iu përshohur kushëve ndërtimeore. Shembuj të montimit gjinden në faqet 91 dhe 92.

A Instalimi në mur.

B Instalimi në mur. Këtu me distancues të lakueshëm përmes vdhkave lidhëse 10-ohje.

C Montimi në sistemin mboqtes.

D Instalimi në pllakat e montimi të shësbëve parafabrikate ose në qelizat e gashsh.

E Instalimi drektë në mur.

F Instalimi me kompletin e shinovave të montazhit #96615000.

Shembujt e instalimit me përmosat dhe dimensionimet e tubacioneve mund t'i gjeni nga faqja 96. Shpjegjimi i simboleve të përdorura gjendet në faqen 84 dhe 85.

Përmosat e montimit të cekura në udhëzimin teknik të montimit janë ideale për personna me gjatësi afro 1800 mm (180 cm) dhe eventualisht duhen përshohur. Këtu duhet posur parasysh që me ndryshimin e Iartësisë së montimit, ndryshon edhe Iartësia e cekur minimale si dhe ndryshimi i përmasave të lidhjeve.

Këshilla rreth montimit

Për të rrotulluar lidhjet duhet lidhur iBox/ me anë të një pjesë të tubit në morë.

Shpëlarje

I gjithë instalimi duhet shpëlarë në bazë të normës DIN 1988 / EN 1717. Shpëlarja në bllokun shpëlarës tregojnë se çlira hyrje është lidhur me cilën dalje, p.sh. uji i ftohje me daljen 1 dhe uji i ngrohtë me daljen 2. Nëse nevojitet vetëm një dalje, atëherë pos shpëlarjes së parë bllokun shpëlarës duhet rrotulluar 90°.

iBox-i në kombinim me në garniturë dalje dhe rriqdhëse Exafill hyrien e vaskës (shih faqen 95)

Të dhëna teknike

Presioni gjatë punës	maks. 1 MPa
Presioni i rekomanduar:	0,1 - 0,5 MPa
Presioni për provë:	1,6 MPa
(1 MPa = 10 bar = 147 PSI)	
Temperatura e ujit të ngrohtë	maks. 80°C
Temperatura e rekomanduar e ujit të ngrohtë:	65°C
Përmosat e lidhjeve:	G ¾
Lidhjet:	i ftohje djathtas - i ngrohtë majtas
Rriqdhja e lirë me 0,3 Mpa:	31 l/min // 24 l/min
Rubineti i vaskës:	
Rubineti i vaskës me kombinim të integruar të sigurisë:	25 l/min // 24 l/min
Shtërkëtesja me ujë të përzier:	32 l/min
Termostati:	43 l/min
Termostati me ventil bllokues:	26 l/min
Termostati me ventil bllokues dhe ventil për ndërrimin e pozicionit:	26 l/min
Termostati High Flow:	58 l/min
iControl:	30 l/min

Shqip

X Mesi i voskës / Mesi i voskës së dushit



Ventili i suvojës

Y

Përmaso Y – mesi i horkur të liqhlës së zorrës deri tek mesi i hyftës së voskës pjesëtim për 2 (eventualisht i duhet përshatur këndit të pllakave të murit).



Valvul devijuese Quattro me kater drejtime

Uji i ngrohtë



Valvul universale Trio për bllokim dhe devijim

Uji i ftohtë



Nga • është i mundur funksioni.

Vrima për mbushjen e voskës



Në këtë zonë është i nevojshëm një perforcim i murit.



Dolja që nuk nevojitet duhet izoluar me topë qorre. (DN 20 3/4")



Ekziston mundësia vetëm për një konsumator, jo për dy njëkohësisht.



Kapociteti i shkarkimit duhet të jetë më shumë se 50 l/minutë.



Vendosni tubacionet e ujit për spërkatëset onëzore me pjerësi:



Shkarkimi



Blloku shpëlarës komplet # 15956000, nuk përfshihet në vëllimin e furnizimit



Raindrain



Exofill

iBoxi në kombinim me në gorniturë dalje dhe rripdhënë Exofill hyjen e voskës (shih faqen 95)

DVGW



Rubineti i voskës me kombinim të integruar të sigurisë (shih faqen 96)



Spërkatësja me ujë të përzier (shih faqen 104, 106, 110, 124)



Rubineti i voskës (shih faqen 98, 102, 114, 116)

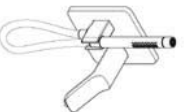

Vrima për mbushjen e voskës (shih faqen 102)

Termostati
(shih faqen 118, 122, 126)



High Flow Termostati
(shih faqen 128 - 138, 142, 144,
150 - 158)



Termostat me ventil bllokues
(shih faqen 104, 106, 110, 124)



Termostat me ventil bllokues dhe ventil
për ndërrimin e pozicionit
(shih faqen 98, 114, 116, 120)



High Flow Termostat me ventil bllokues
(shih faqen 140, 146, 148)

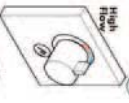

Termostat me ventil bllokues
(shih faqen 104, 106, 110)

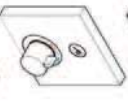

Termostat me ventil bllokues
(shih faqen 98, 114, 116, 120)

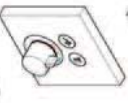

Termostat me ventil bllokues
(shih faqen 100, 112)



ShowerSelect SperiKontjo me ujë të
perzire
(shih faqen 104, 106, 110)

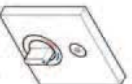

ShowerSelect Rubineti i vaskës
(shih faqen 98, 114, 116, 120)



iControl
Valvula e bllokimit dhe e derëzimit (shih
faqen 150)



ShowerSelect
3 x Ventil bllokues (shih faqen 144,
146 - 150, 158)

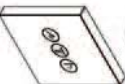

Raindance Showerpipe
(shih faqen 108)



Raindance Rainfall 240
(shih faqen 140, 142)



Raindance Rainfall 180
(shih faqen 154 - 158)



Raindance E 420
(shih faqen 150, 152)



Raindance Select E 300
(shih faqen 148)

ثيومستات
(راجع صفحة 118, 122, 126)



ثيومستات High Flow
(راجع صفحة 128 - 138, 142, 144, 150 - 158)



ثيومستات متصل بسمام غلق
(راجع صفحة 104, 106, 110, 124)



ثيومستات متصل بسمامات غلق
وختول
(راجع صفحة 98, 114, 116, 120)



غلق High Flow ثيومستات متصل بسمام
(راجع صفحة 140, 146, 148)

ثيومستات متصل بسمام غلق
(راجع صفحة 104, 106, 110)



ثيومستات متصل بسمام غلق
(راجع صفحة 98, 114, 116, 120)

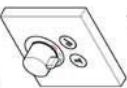

ثيومستات متصل بسمام غلق
(راجع صفحة 100, 112)

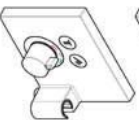

ShowerSelect
خلط الدش
(راجع صفحة 104, 106, 110)

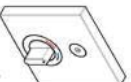

ShowerSelect خلط دش الخمام
(راجع صفحة 98, 114, 116, 120)

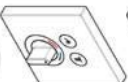

Control
صمام الحجر والتغير (راجع صفحة 150)



ShowerSelect
3 x صمام إبطاف (راجع صفحة 144, 146, 150 - 158)

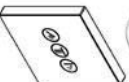

Raindance Showerpipe
(راجع صفحة 108)
Raindance Rainfall 240
(راجع صفحة 140, 142)

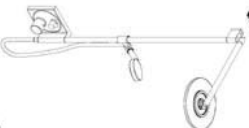

Raindance Rainfall
180
(راجع صفحة 154 - 158)

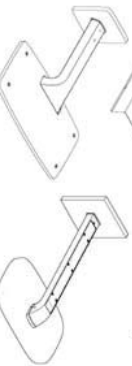

Raindance Select E 300
(راجع صفحة 148)
Raindance E 420
(راجع صفحة 150, 152)

X

متنصف حوض الاستحمام / بانيو مزود
ببش في المنتصف

صمام التدفق

Y

البعد Y = مركز مرفق مخرج حائط
الخرطوم إلى مركز حشوة الغمام مقسوماً
على 2 أمطابق لشكل البلاطة إن أمكن.

تغيير مسار رياحي كوابلو



ماء دافئ



صمام حنجرة وتغيير تروبو يونيفرسال

ماء بارد



من * الوطيفة مضمونة.



مدخل مياه للبانو



يلزم هذا في النطاق وجود تقوية للحائط.



قم بسد المنفذ غير المستخدم، DN 20



لا يمكن القيام بأكثر من وظيفة واحدة.

قم بسد المنفذ غير المستخدم،
3/4"يجب أن تكون قدرة الصرف أكبر من 50
لتر/دقيقةقم بتثبيت مواسير المياه للشد العادي
للحجر.

تصريف

قارئة وحدة القسمل #15956000، غير
مدح مع الفتوات السائلةوحدة "Box" مع وحدة التدفق بالوخز
من النوع "Exofill" مع لوازيم تصريف للماء
وتصريف تدفق المياه. (راجع صفحة 95)

DVGW

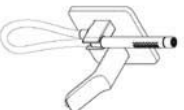
خلاط بش الغمام مجموعة أمن مصممة
(راجع صفحة 96)خلاط بش الغمام
(راجع صفحة 98, 102, 114, 116)خلاط المش
(راجع صفحة 104, 106, 110, 124)مدخل مياه للبانو
(راجع صفحة 102)

تعد أبعاد التركيب الواردة في إرشادات التركيب هذه مقابلة بالمتسقة للأشخاص الذين يبلغ طولهم حوالي 1800 م، ولكن تغيير الأبعاد عند الحاجة وبالتالي ستبقى لك الأذى لا يرتفع في حالة تغيير ارتفاع التركيب، ما يعني الأذى في الاعتبار تغيير أبعاد التوصيل.

نصائح خاصة بعملية التركيب

من أجل لكf الوصلات، يجب تركيب وحدة "Box" في اللزومة باستخدام أنبوبة.

نظام سريان الماء عبر المواسير

يجب غسل الوحدة المركبة بالكامل وفقًا للمعيار DIN 1988/EN 1717. تحدد الأسموم الموجودة على وحدة الغسل أي فيق يرتبط بالماء وصلة متدفق. على سبيل المثال: المياه الباردة مع التدفق رقم 1، والمياه الساخنة مع التدفق رقم 2. إذا كان هناك حاجة إلى منفذ واحد فقط يجب لكf وحدة الغسل قبل أول استخدام لها بنسبة 90 درجة.

وحدة "Box" مع وحدة التدفق بالكرؤض من النوع "Exaffil" مع لوازيم تصريف الماء وتصريف تدفق المياه. (راجع صفحة 95)

المواصفات الفنية

ضغط التشغيل	الحد الأقصى 1 ميجاسكال
ضغط التشغيل الموصى به:	0,5 - 0,1 ميجاسكال
ضغط الاختبار:	1,6 ميجاسكال
1) درجة حرارة الماء الساخن	PSI 147 = بار 10
درجة الحرارة الموصى بها للماء الساخن:	80° C
درجة الحرارة القصوى:	65° C
المسافة المركبة:	3/4 G
الوصلات:	الماء الباردة جهة اليمين - الماء الساخن جهة اليسار
معدل تدفق 0,3 ميجاسكال:	الدقيقة // 24 لتر / الدقيقة
حلاط شش الحمام بمجموعة أمن مدمجة:	الدقيقة // 24 لتر / الدقيقة
حلاط شش الحمام بمجموعة أمن مدمجة:	الدقيقة // 25 لتر / الدقيقة
حلاط الشش:	الدقيقة // 32 لتر / الدقيقة
ثرموستات:	الدقيقة // 43 لتر / الدقيقة
ثرموستات متصل بصمام غلق:	الدقيقة // 26 لتر / الدقيقة
ثرموستات متصل بصمامات غلق وكؤول:	الدقيقة // 26 لتر / الدقيقة
ثرموستات High Flow:	الدقيقة // 58 لتر / الدقيقة
ثرموستات Control:	الدقيقة // 30 لتر / الدقيقة

تركيب الأنابيب

يتم استخدام الجسم الرئيسي لوزالدوران للمثال للوحدة "Box" في جميع أنحاء العالم سواء بصورة أفقية أو رأسية، إلا أنه لا يمكن القيام بالتركيب إلا بصورة رأسية في هذه الحالة إلا في حالة تركيب لوازيم الكؤوض باستخدام تركيبة الأمان. المحرض دوماً على تركيب Box فوق كؤوض الامستخدام البائتياً، إذا تعرضت أجزاء من Box للأشخاص، فربما يتسبب ذلك في تسرب المياه في كل مكان.

تعد وحدة "Box" ملائمة لتركيب كؤوض الاستخدام أو الشش، وفي حالة استخدام حلاط بالكرؤوض بمسبور واحد فقط / ثرموستات متصل بصمام غلق وكؤول، يفضل استخدام الصرغ السفلى، وعند القيام بتركيب الشش، يجب سد المنفذ غير المستخدم عن طريق سدادة.

يجب أن يكون تيار الماء الساخن والماء الباردة متعادلين في الضغط.

قم بتركيب الجسم الرئيسي للوحدة بصورة ملائمة بحيث توجد وصلة المياه الساخنة في الجانب الأيسر ووصلة المياه الباردة في الجانب اليمين.

عمق التركيب: من 80 م حتى 108 م.

وصلة إطالة 25 م، رقم الصنف 13595000

طقم الملحقات 22 م (عدداً لا يكون الحدار عميقاً بما يكفي).

رقم الصنف 13593000 / 13597XXX / 13596XXX
13597000 / 19427000 / 97407XXX / 98860000

يمكن تركيب الجسم الرئيسي للوحدة وفقاً لطرفو البناء، انظر أمثلة التركيب صفحتي 91 و 92.

- A التركيب على حائط مباشر
- B التركيب على الحائط المباشر بجوابط تركيب قابلة للضغط طولها 10 م.
- C التركيب على نظام حمامات.
- D التركيب على حائط مجوف
- E التركيب على حائط من الطوب
- F التركيب باستخدام طقم الانثيت #96615000.

يوجد بدءاً من صفحة 96 أمثلة للتركيب بمقاسات وطرق عمل بعض الوصلات، يوجد شئح للرموز المستخدمة على الصفحات 86 و 87.

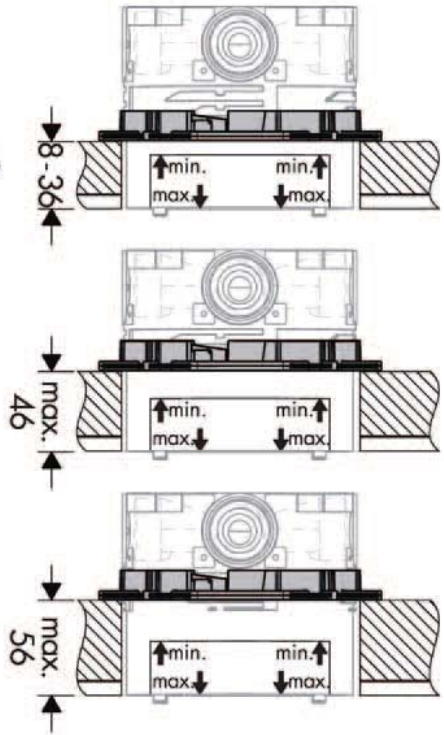
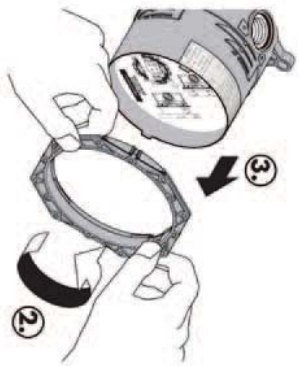
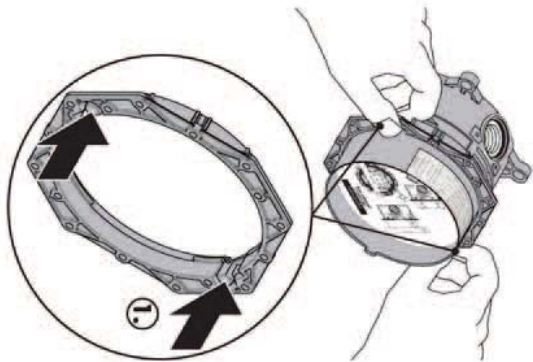

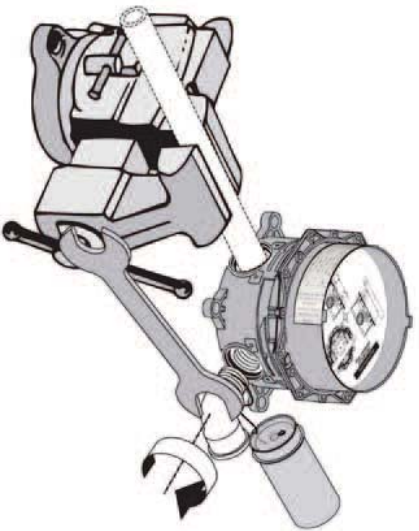
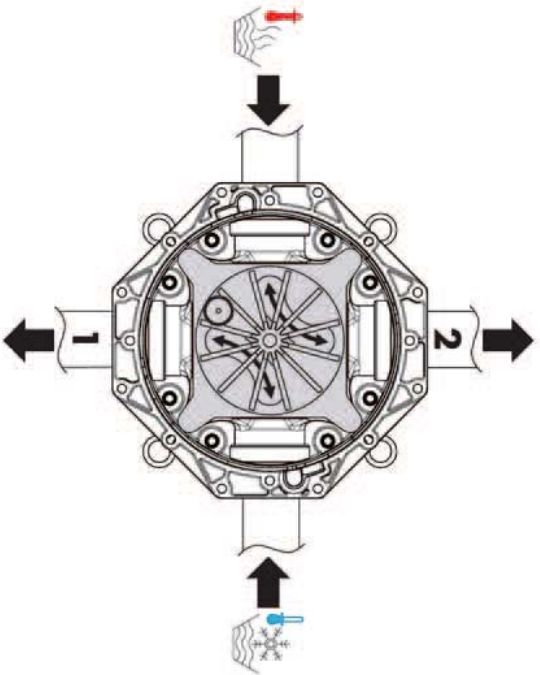

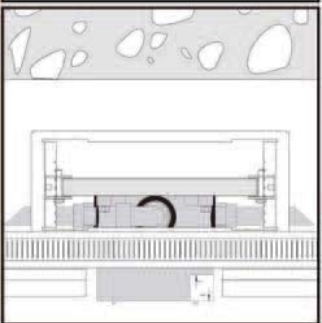
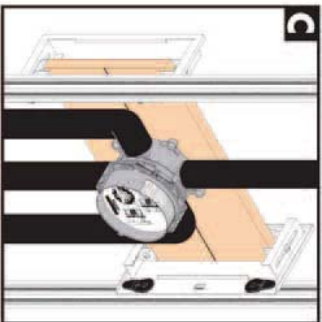
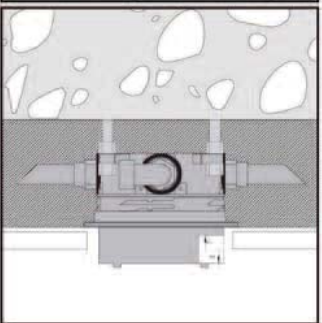
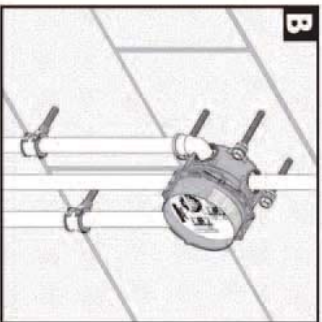
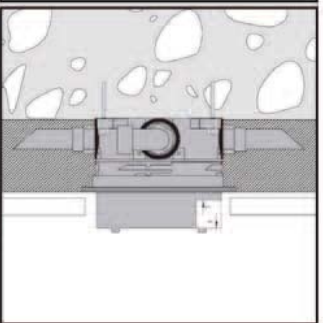

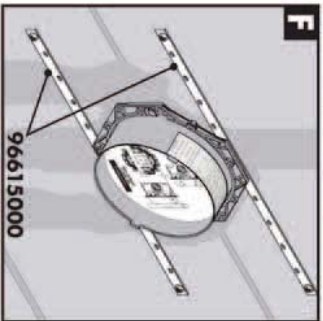
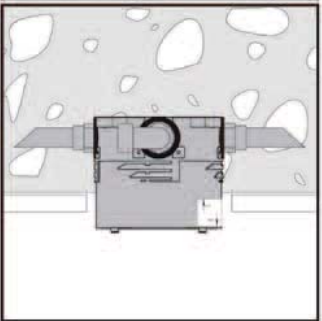
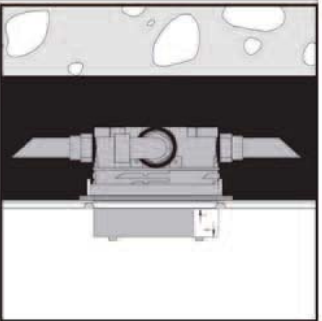
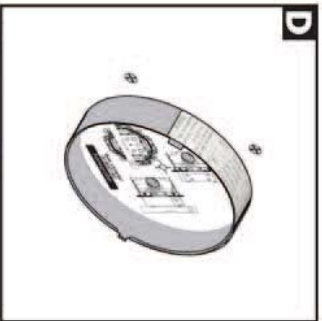

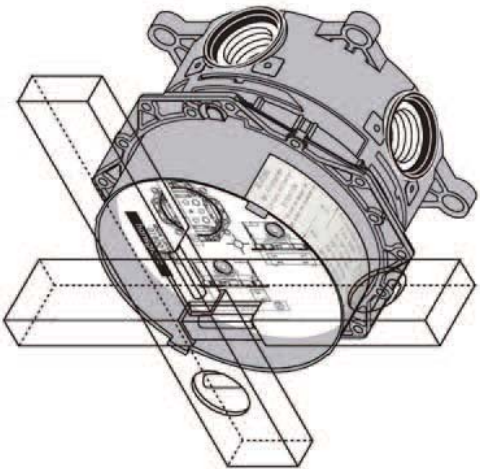
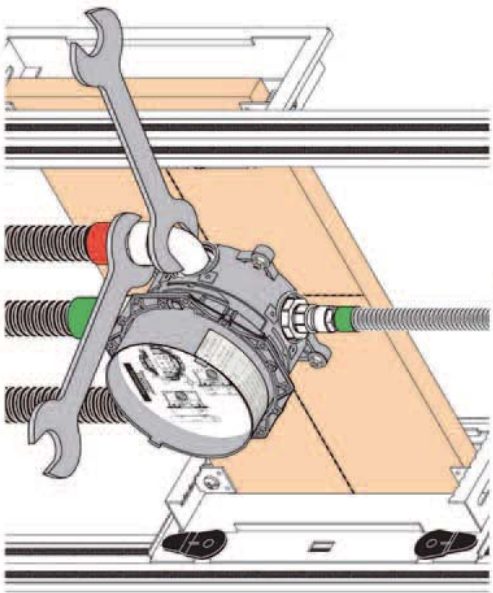

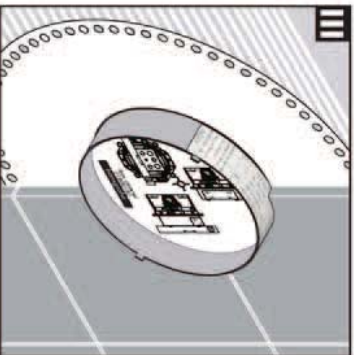
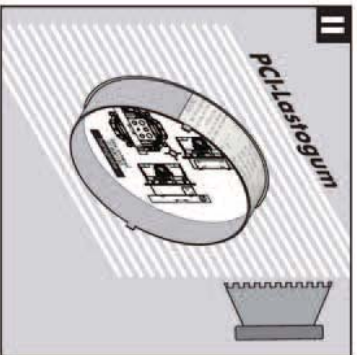
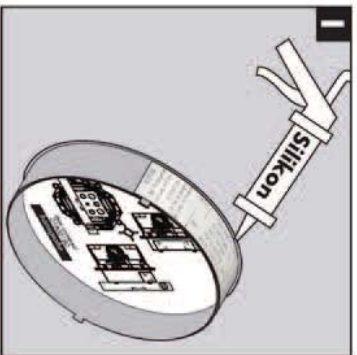

Prüfzeichen / Classification acoustique et débr / Test certificate / Segno di verifica / Marca de verificación /
 Keurmerk / Godkendelse / Marca de control / Znak jakości / Zkušební značka / Osvědčení o akústice / 检验标
 記 / Знак технического контроля / Vizualiziel / Koelustusmerki / Testsigill / Bandyne pažyma / Označka testování /
 Kontrol izavei / Certificat de testare / Τύπος έγκυρου / Prekuzni znak / Kontrollsertifikaati / Pārbaudes zīme / Испити
 знак / Провемерке / Контролни знак / Шенга в контролли / 检测标志

PAIX **DVGW** **SVGW** **WRAS** **KIWA** **ACS**

PA-IX 1 8989 / ID BP-5615 X X X X X



iBox universal + Exafill

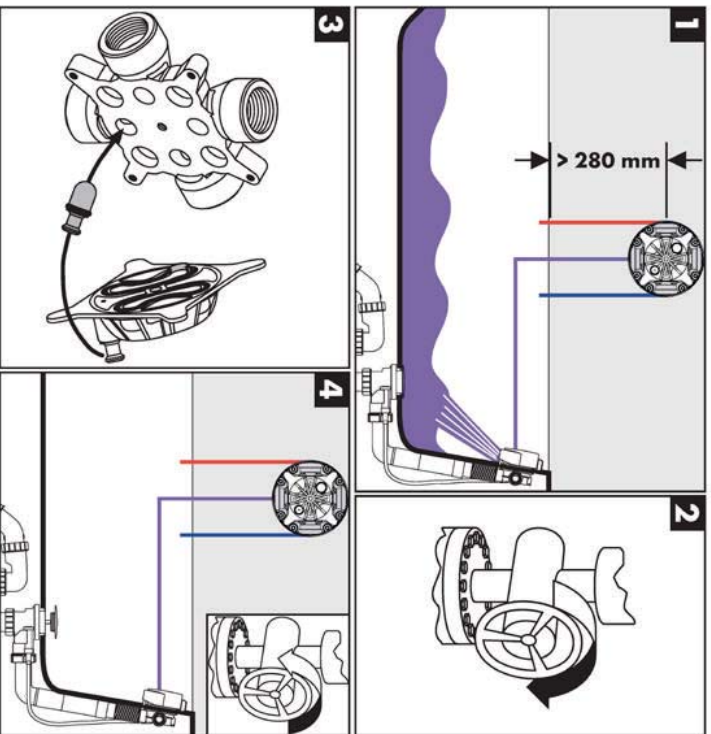
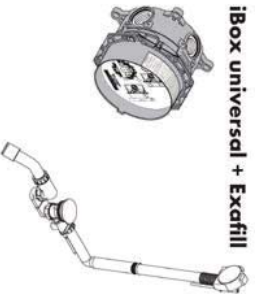

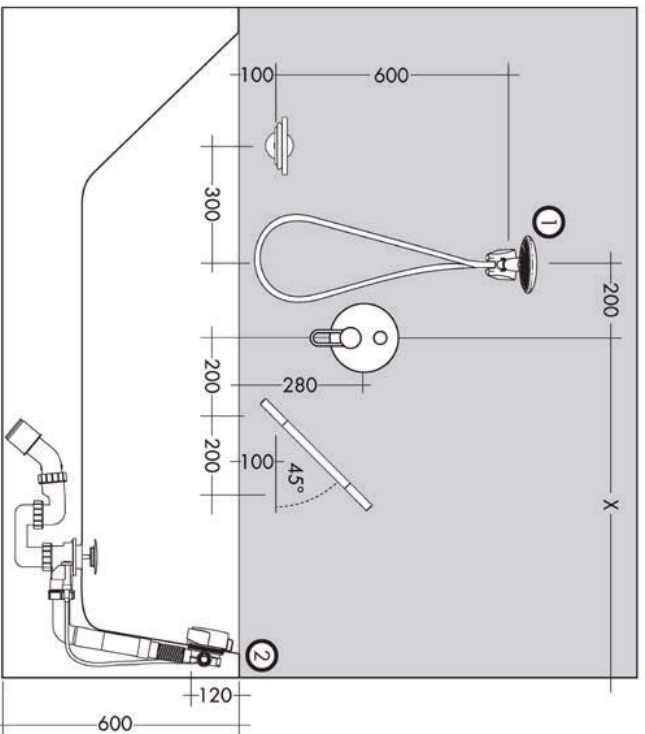
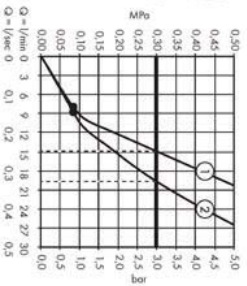

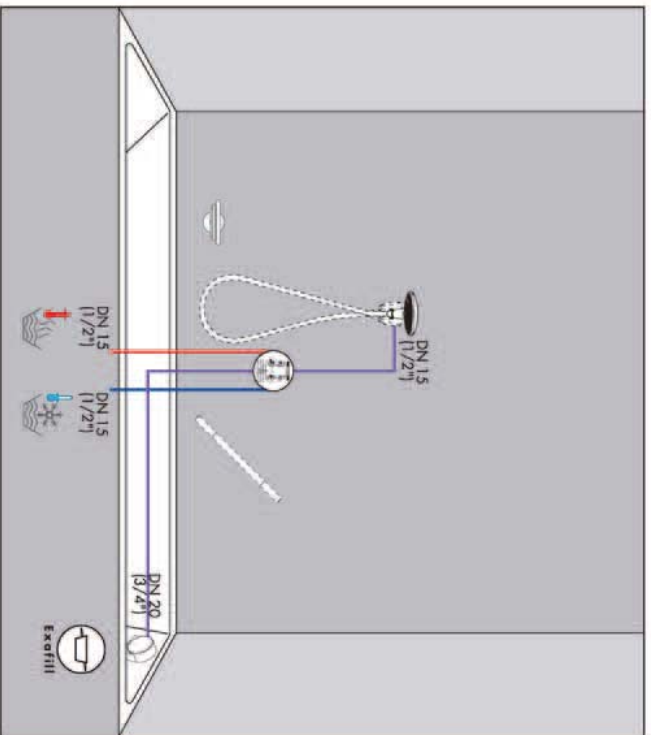

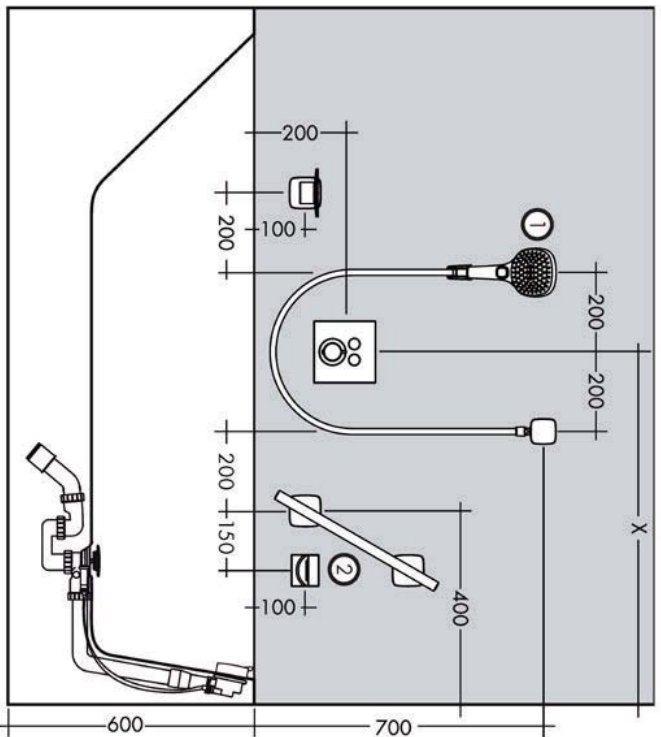
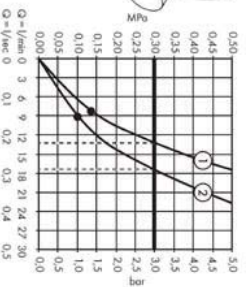
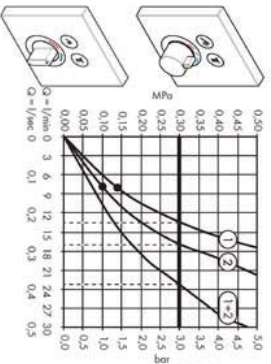

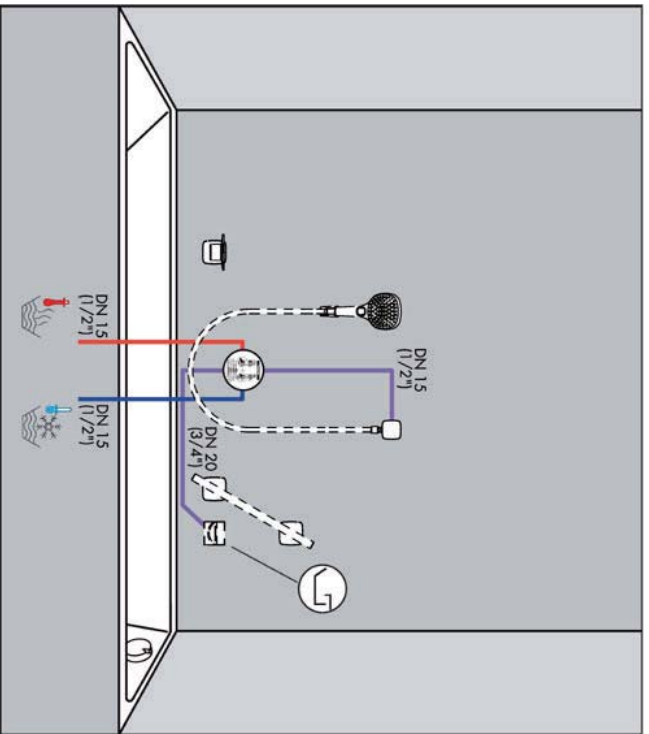
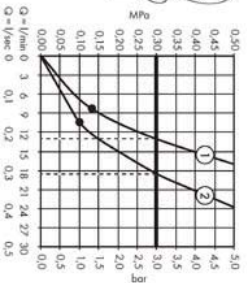

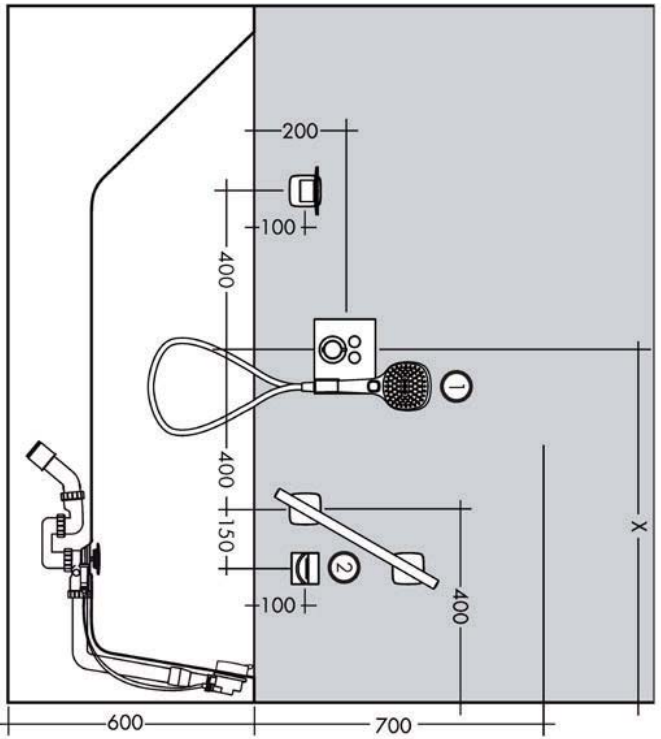
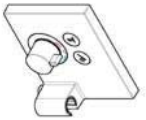
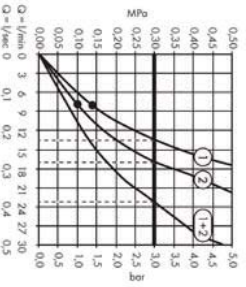

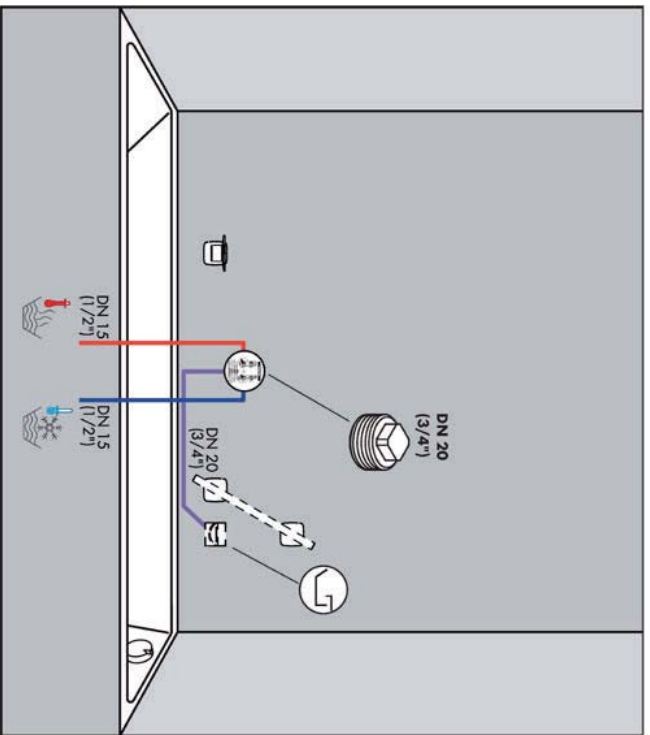

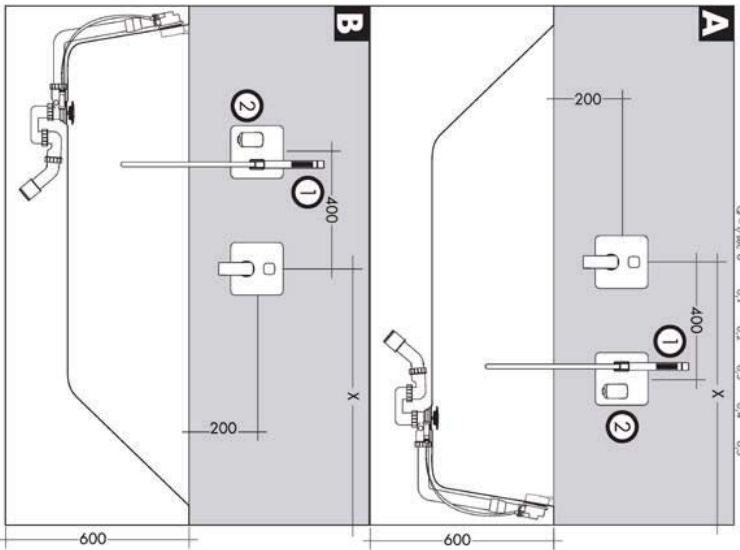
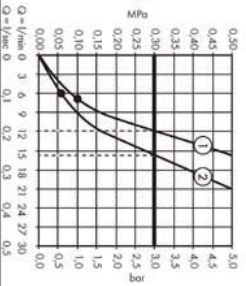

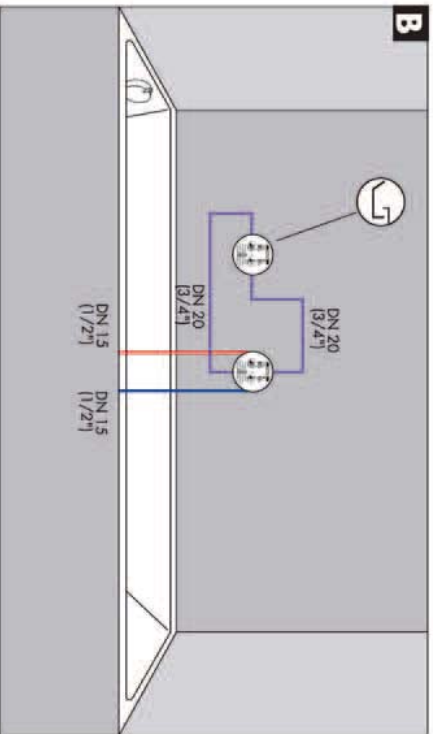
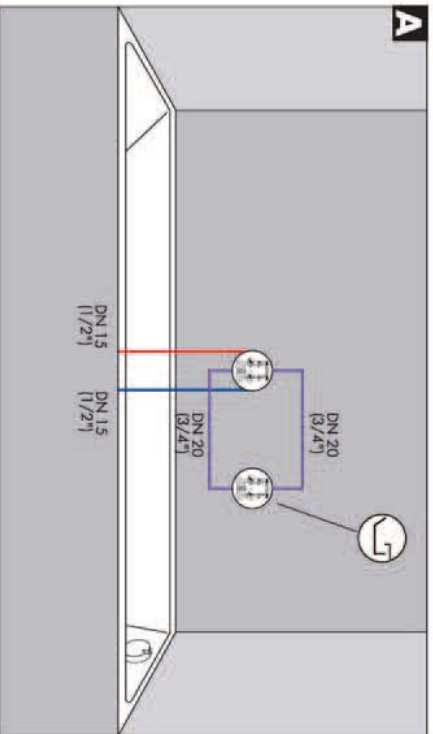

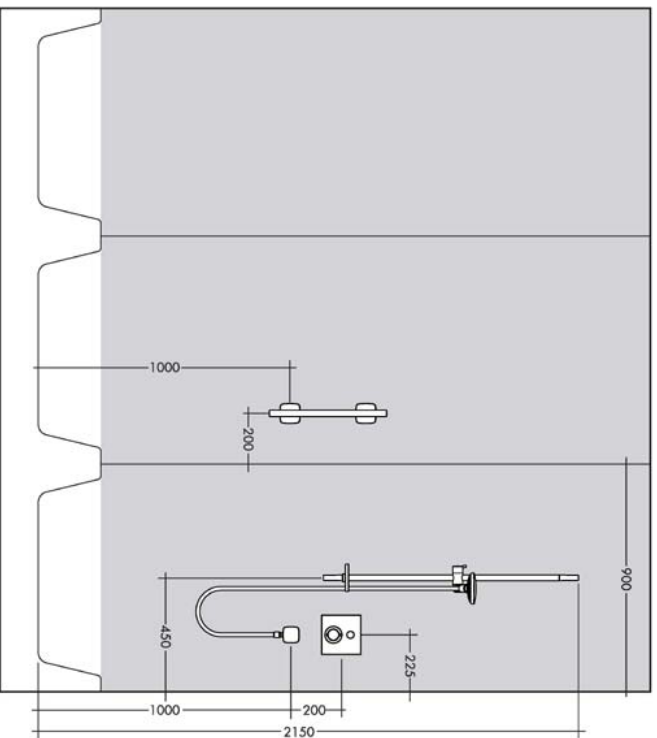
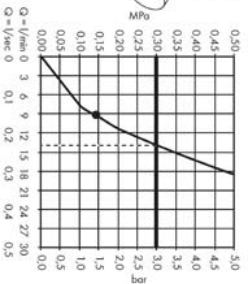
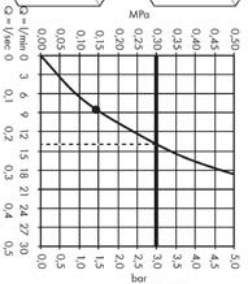
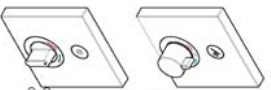

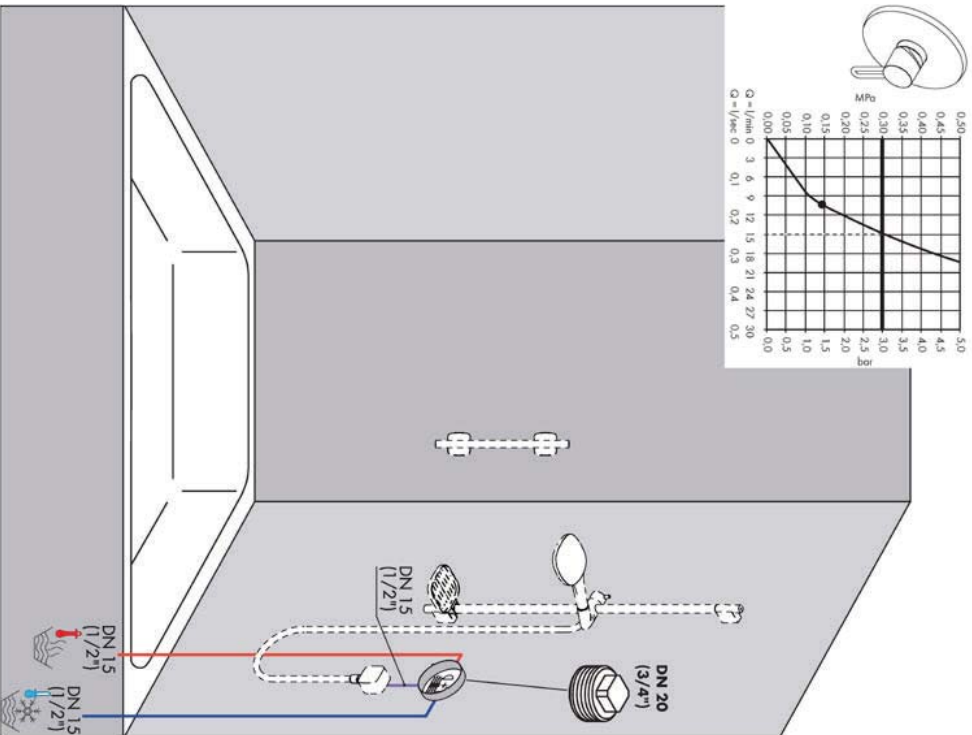

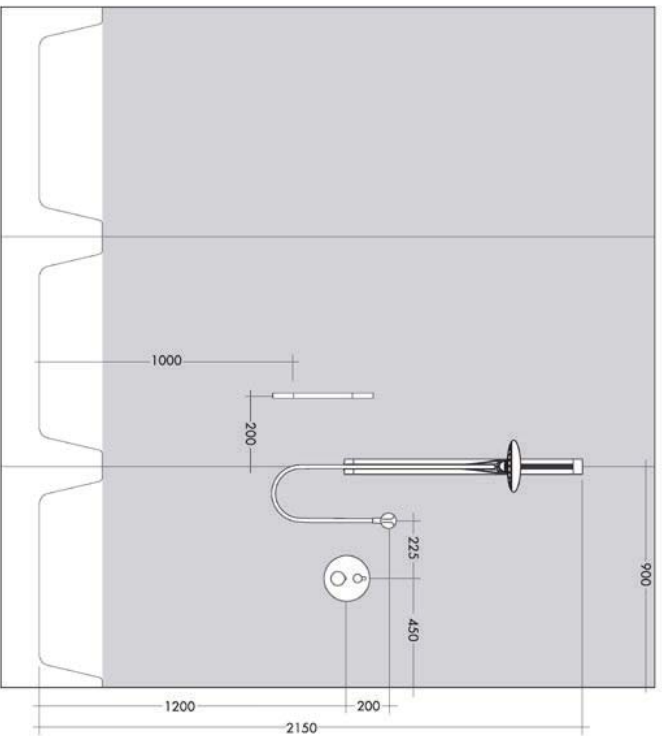
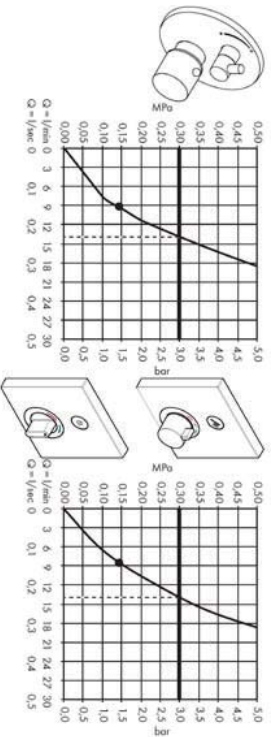

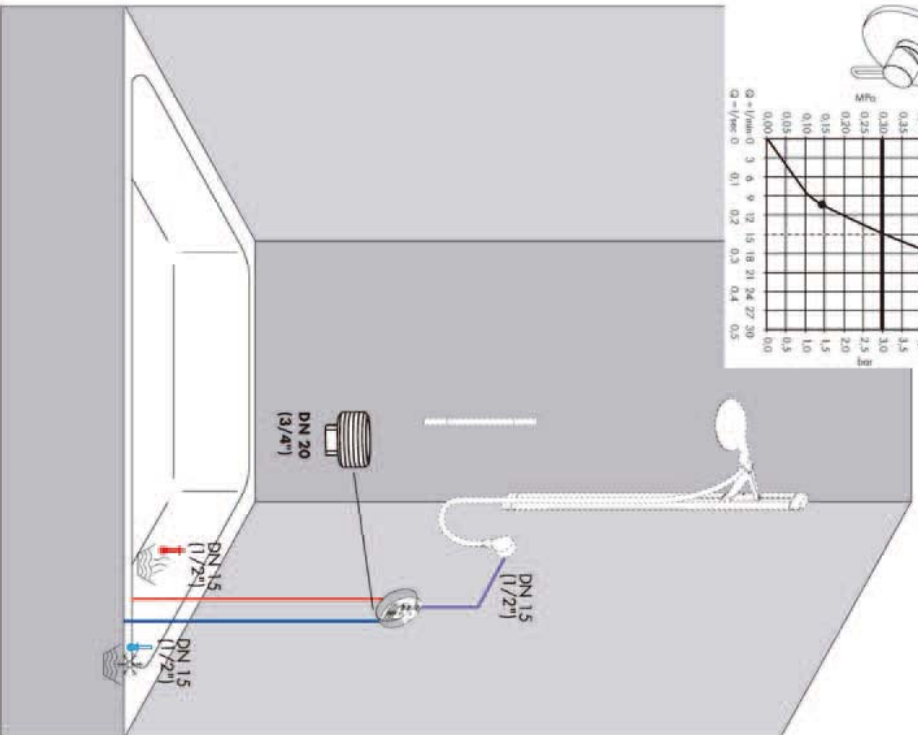
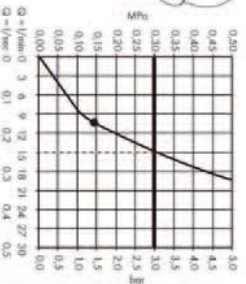

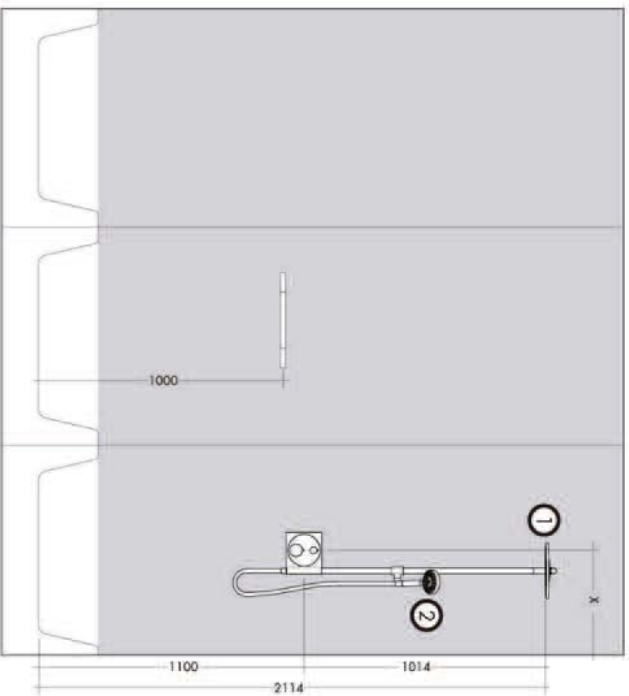
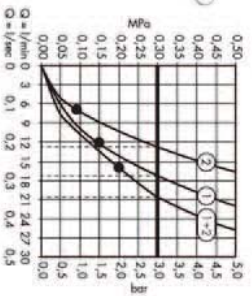

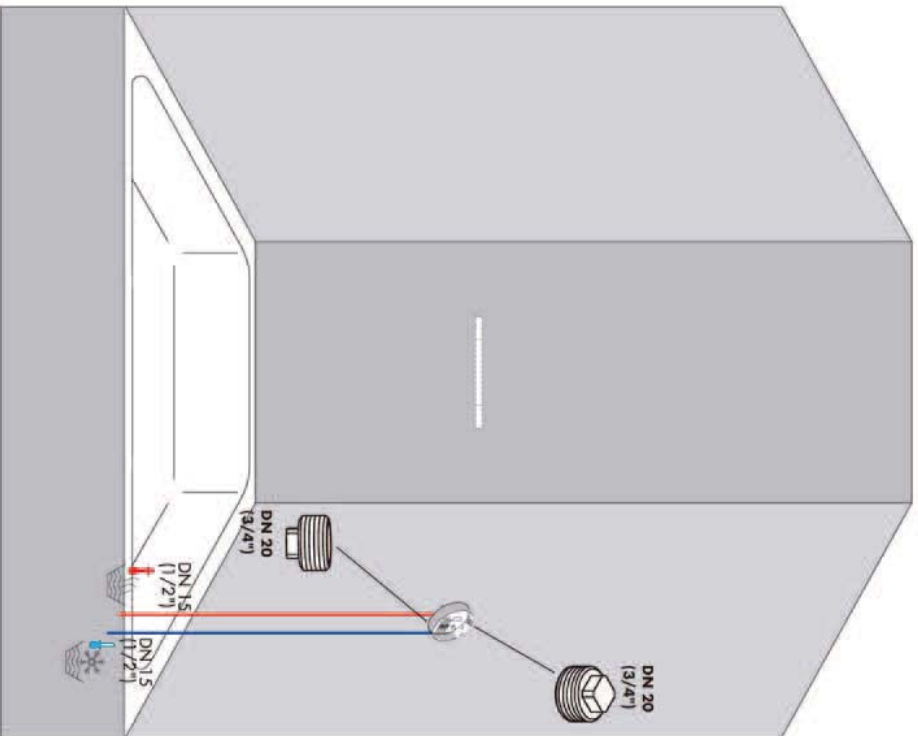

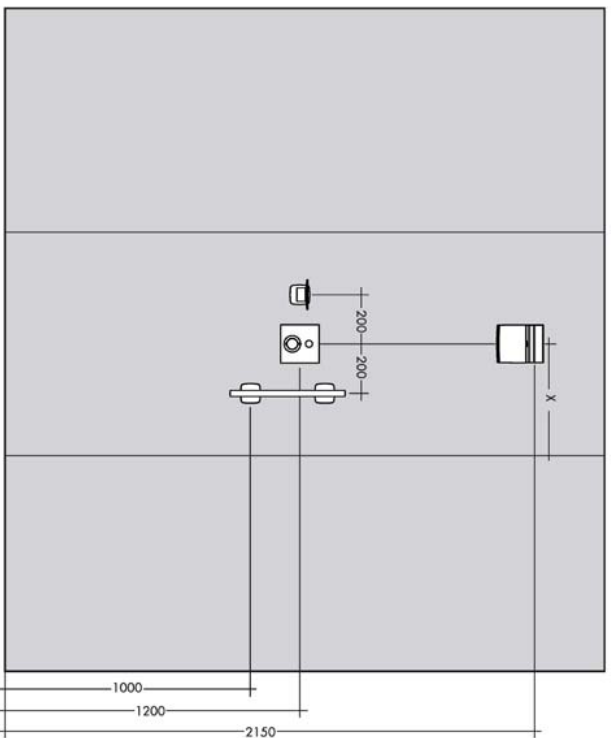
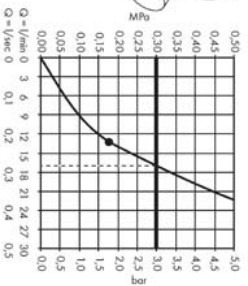
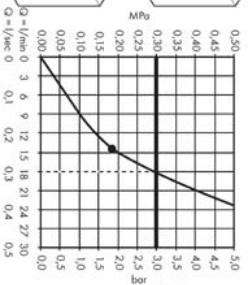

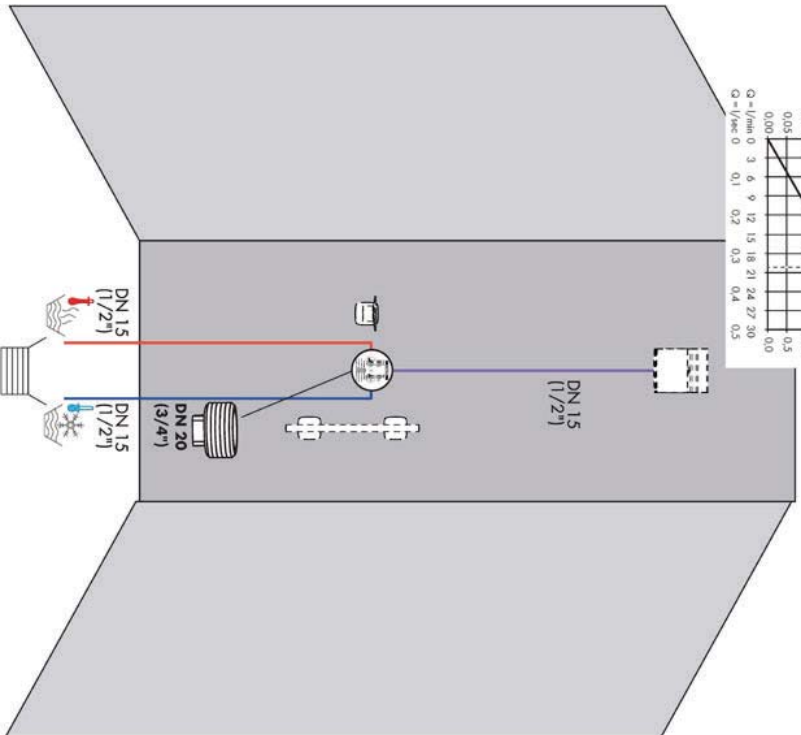
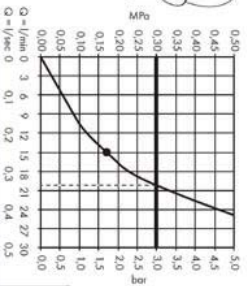

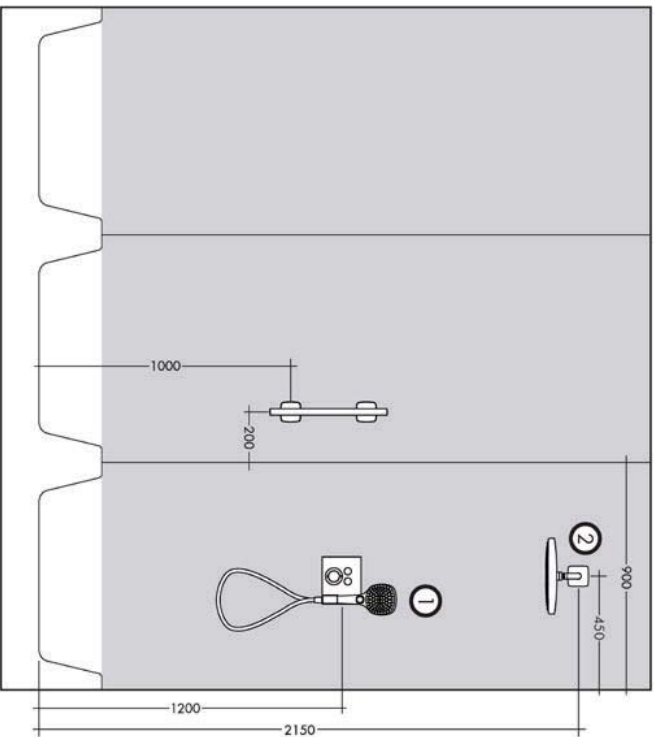
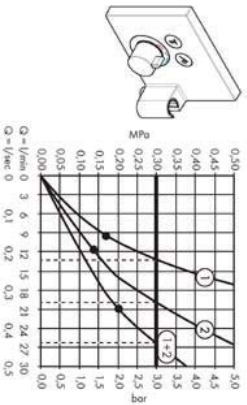

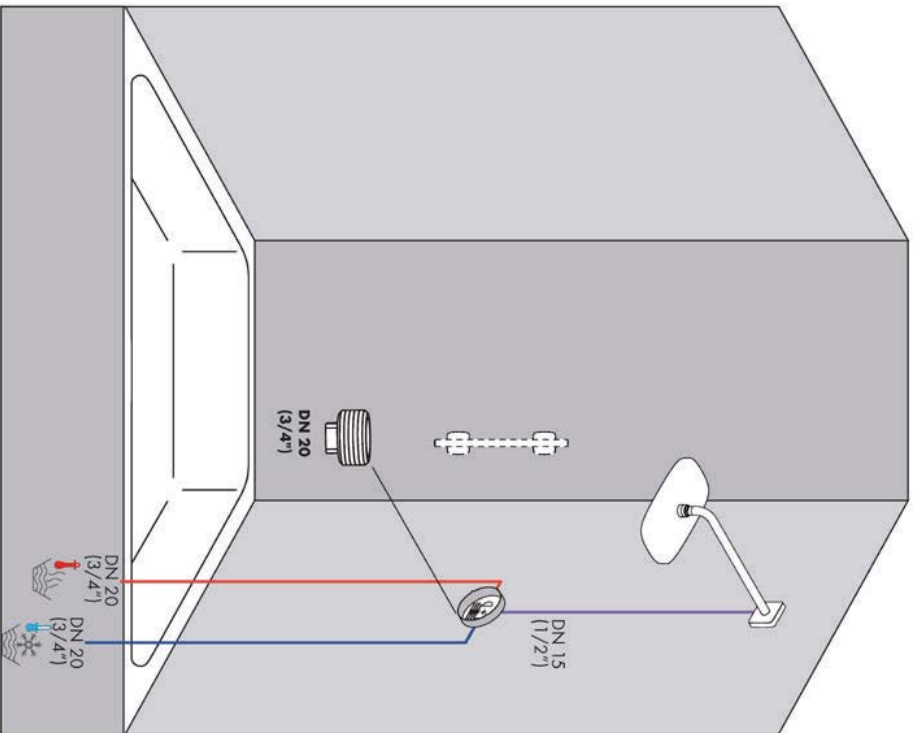

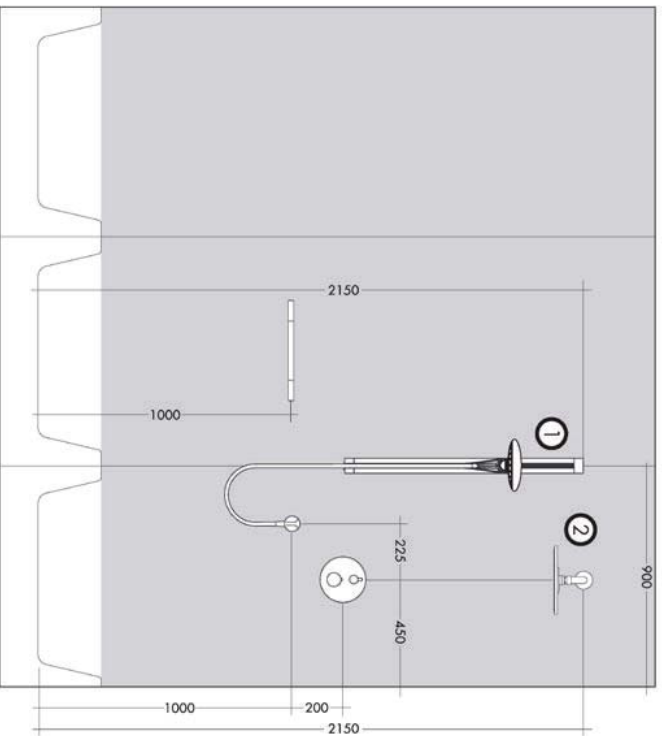
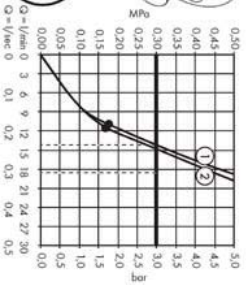
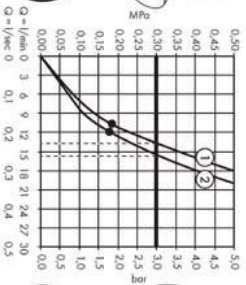

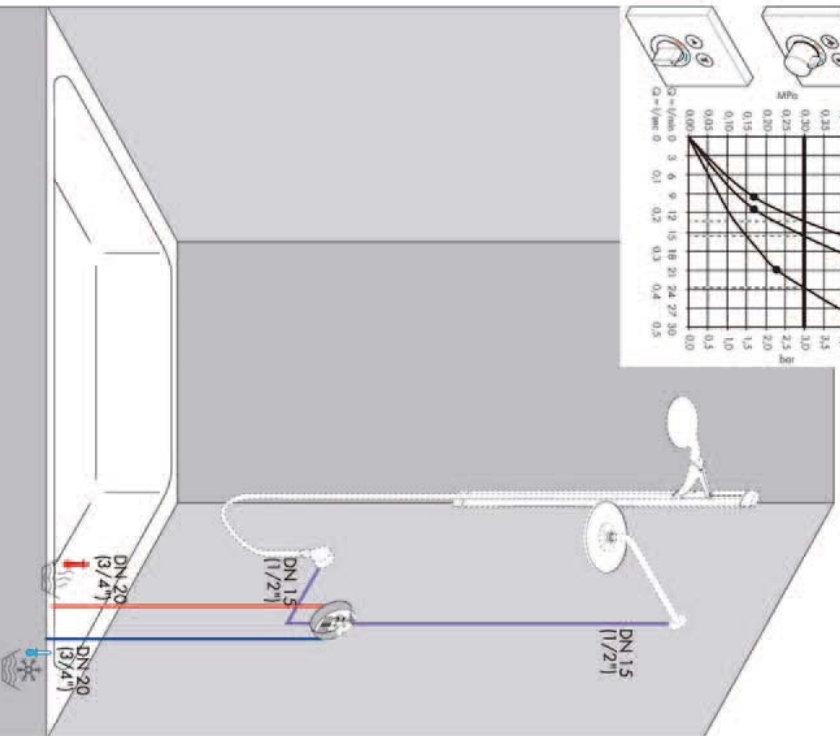
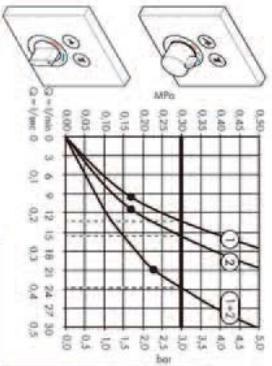

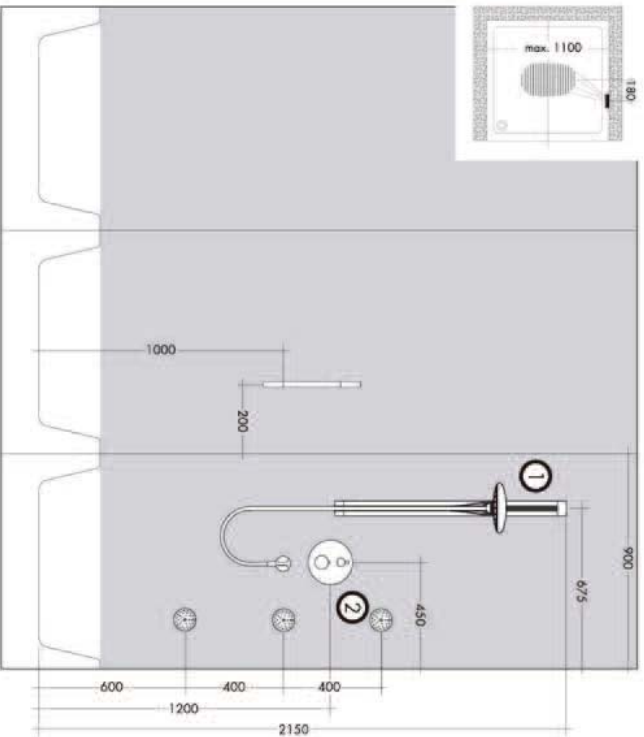
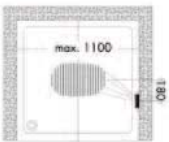
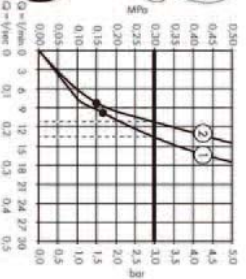
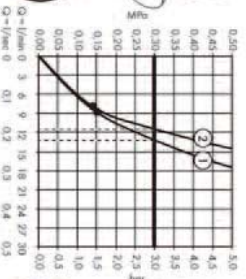

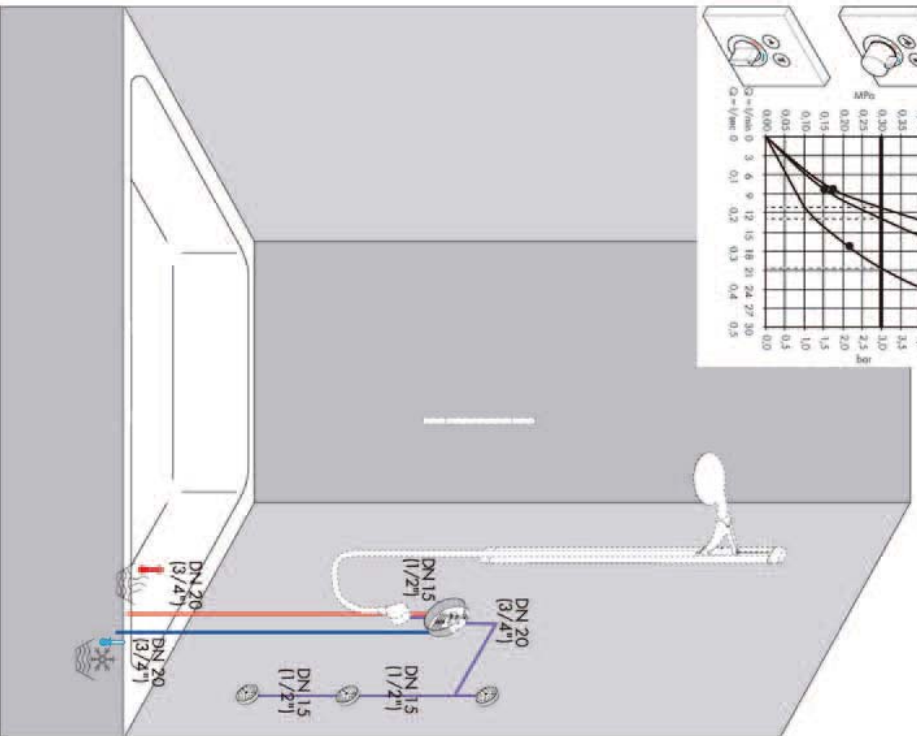
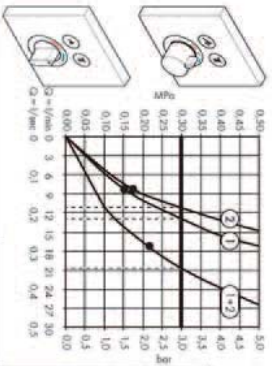

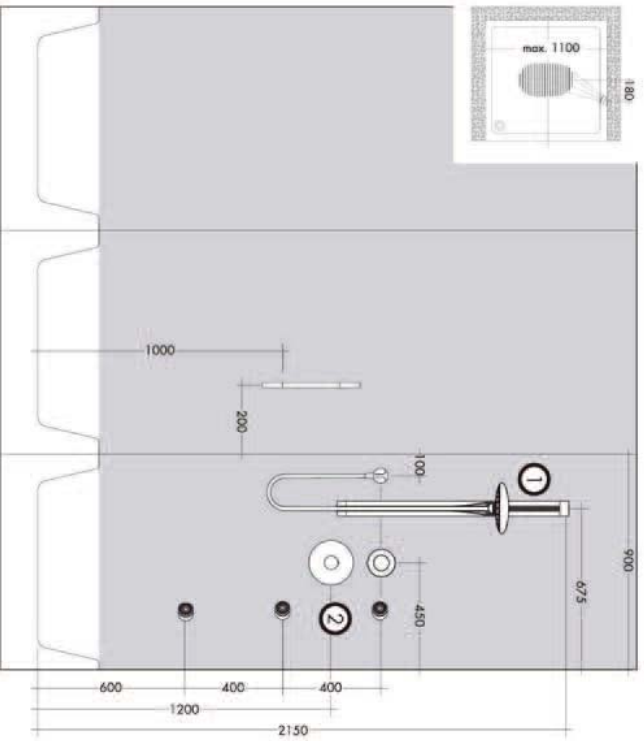
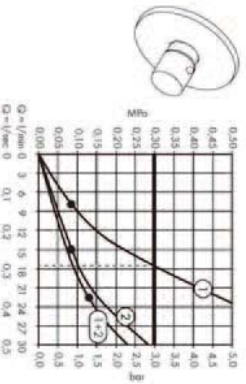

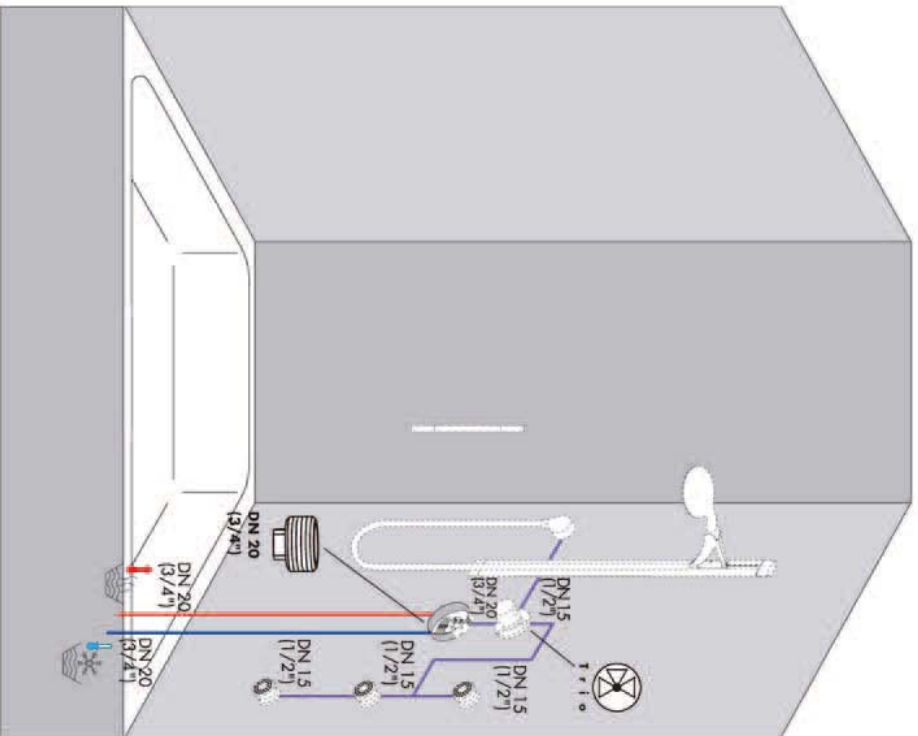

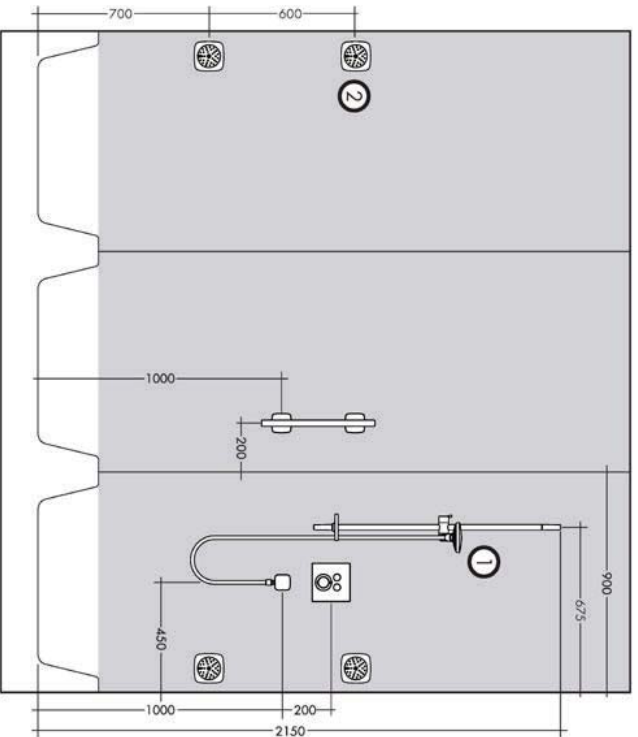
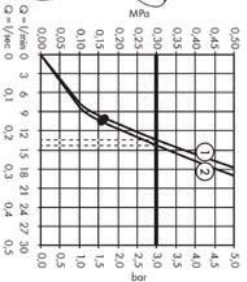
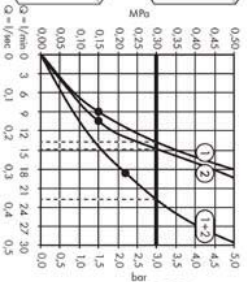

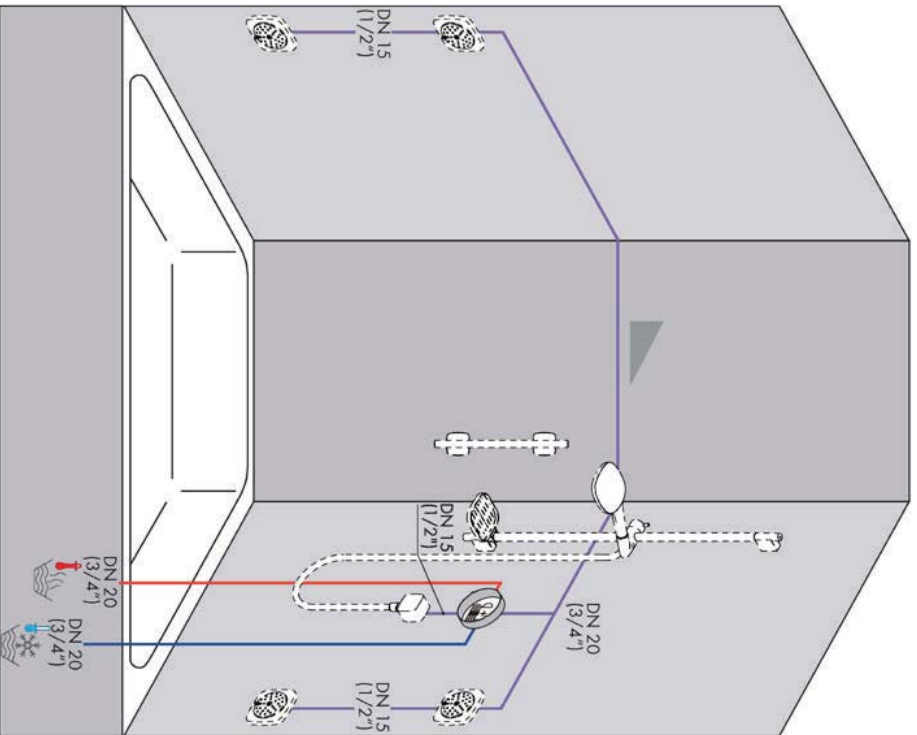

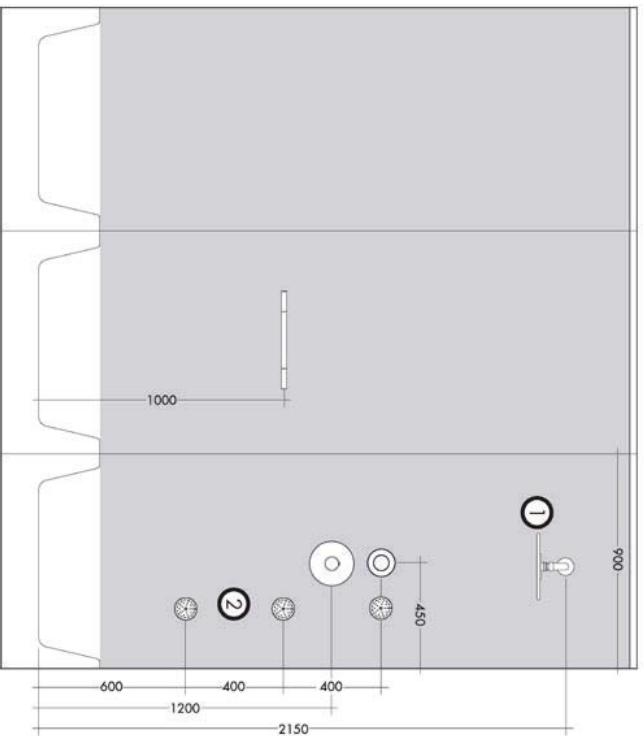
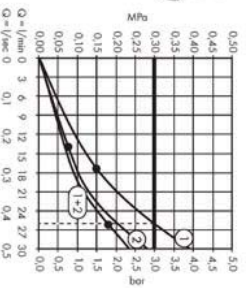

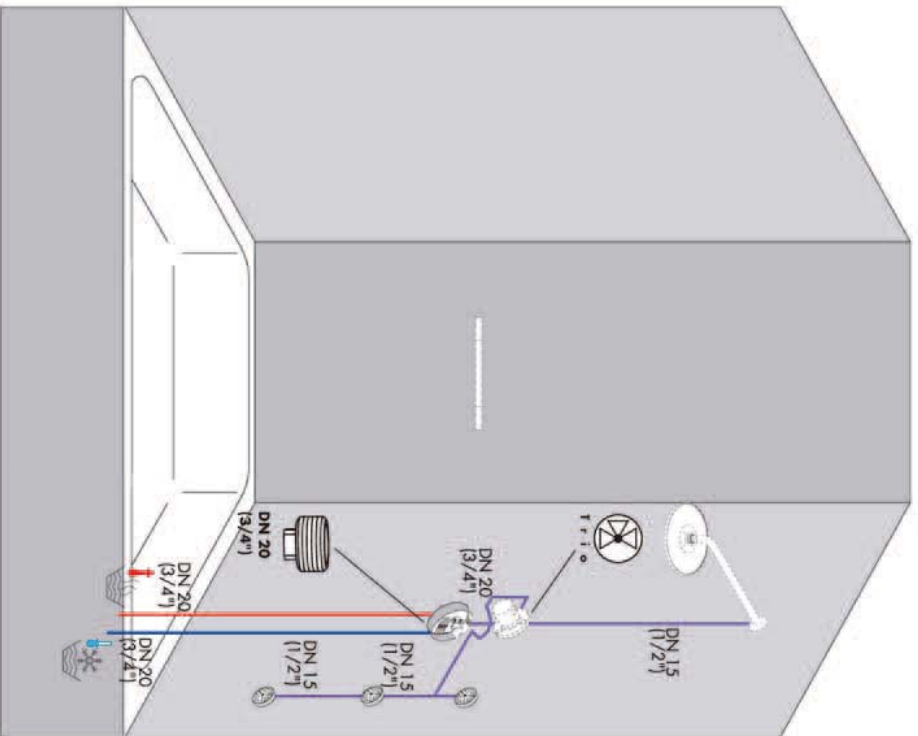

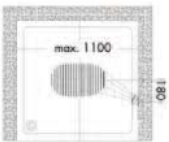
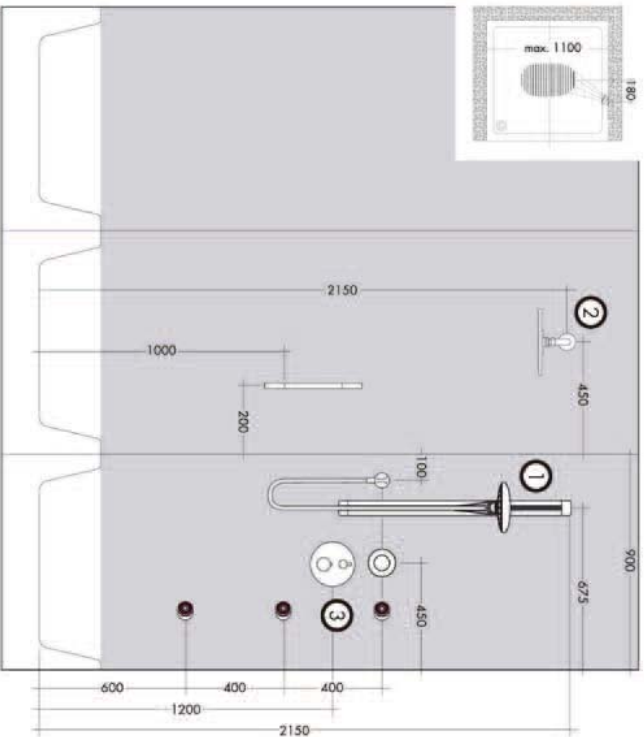
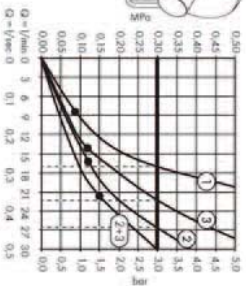
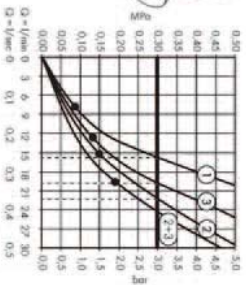

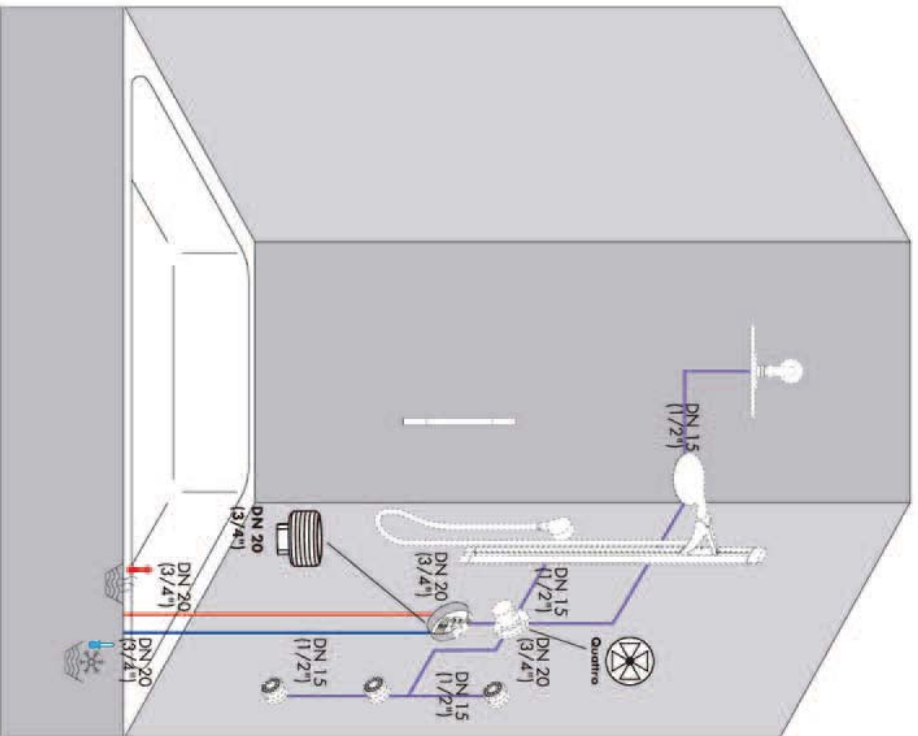

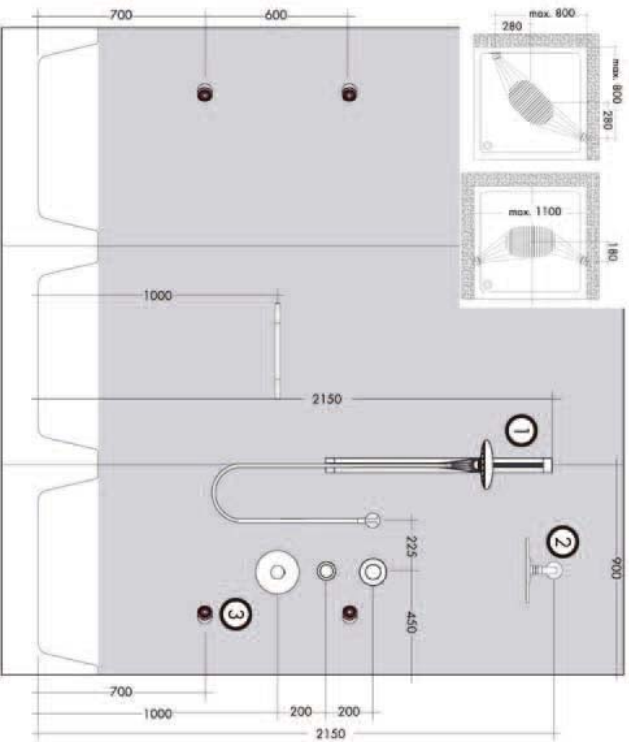
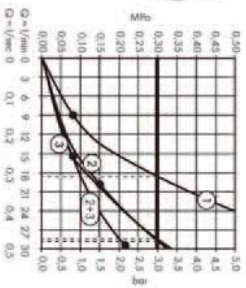

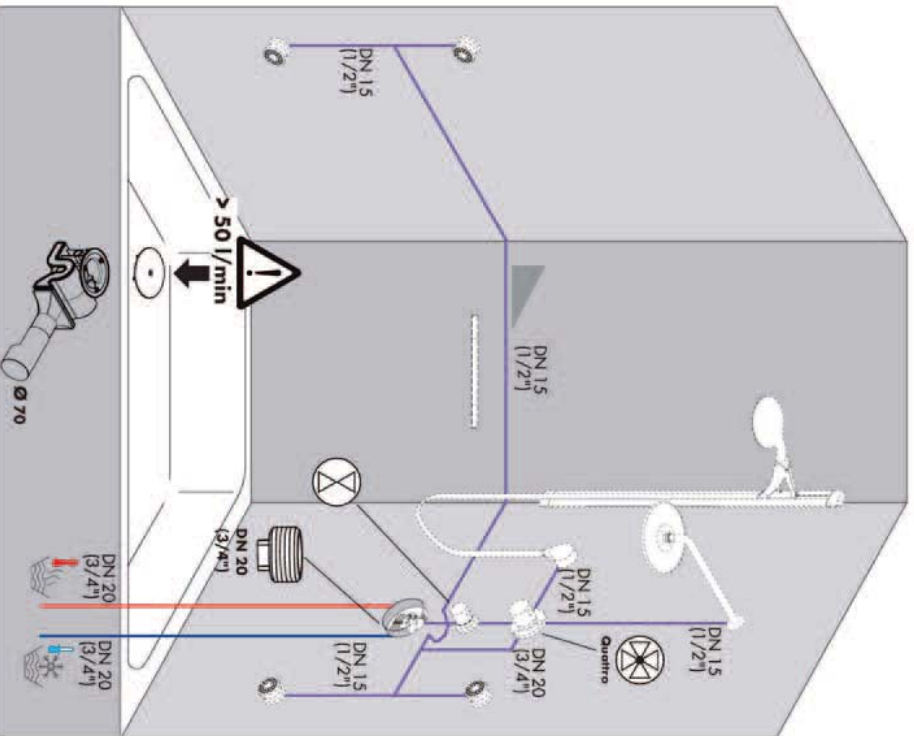

Ø 70

> 50 l/min

DN 15
(1/2")

DN 15
(1/2")

DN 20
(3/4")

DN 15
(1/2")

DN 20
(3/4")

Quattro

DN 15
(1/2")

DN 15
(1/2")

DN 15
(1/2")

DN 20
(3/4")

DN 20
(3/4")

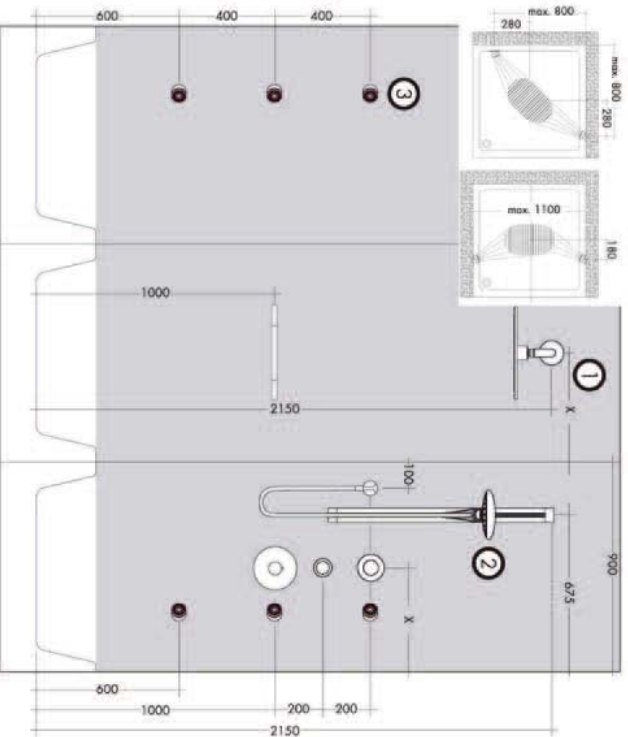
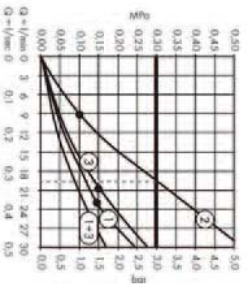

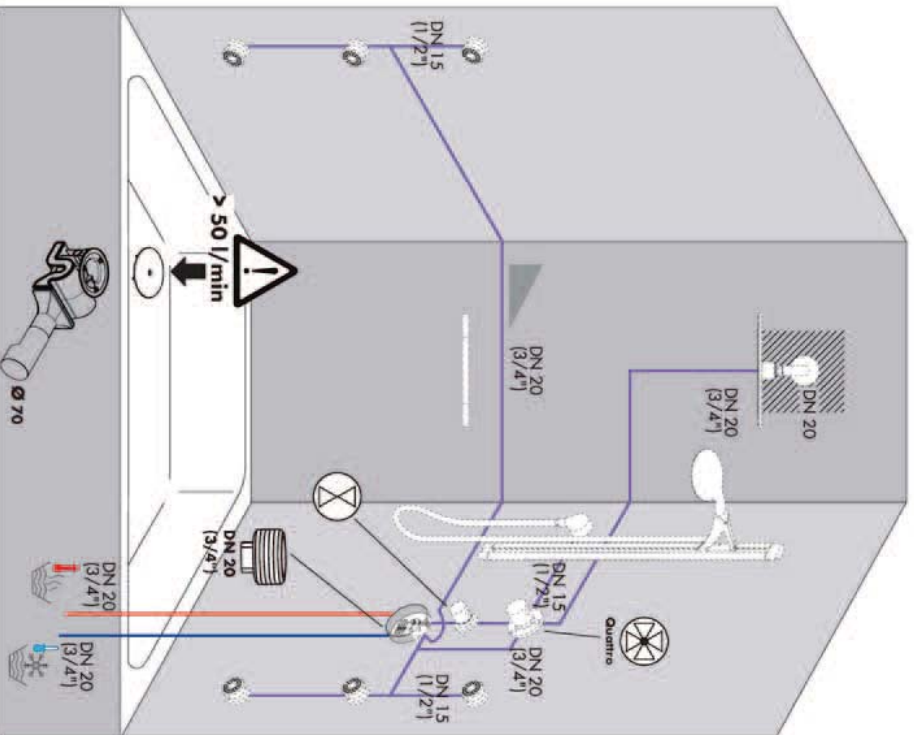



High
flow

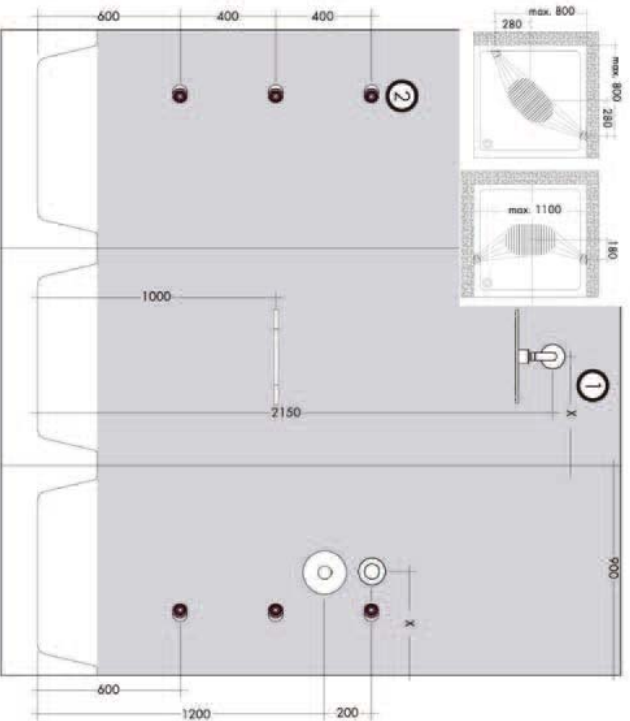
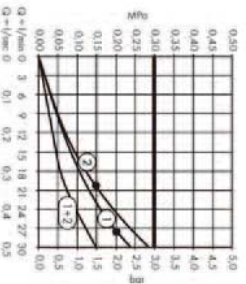

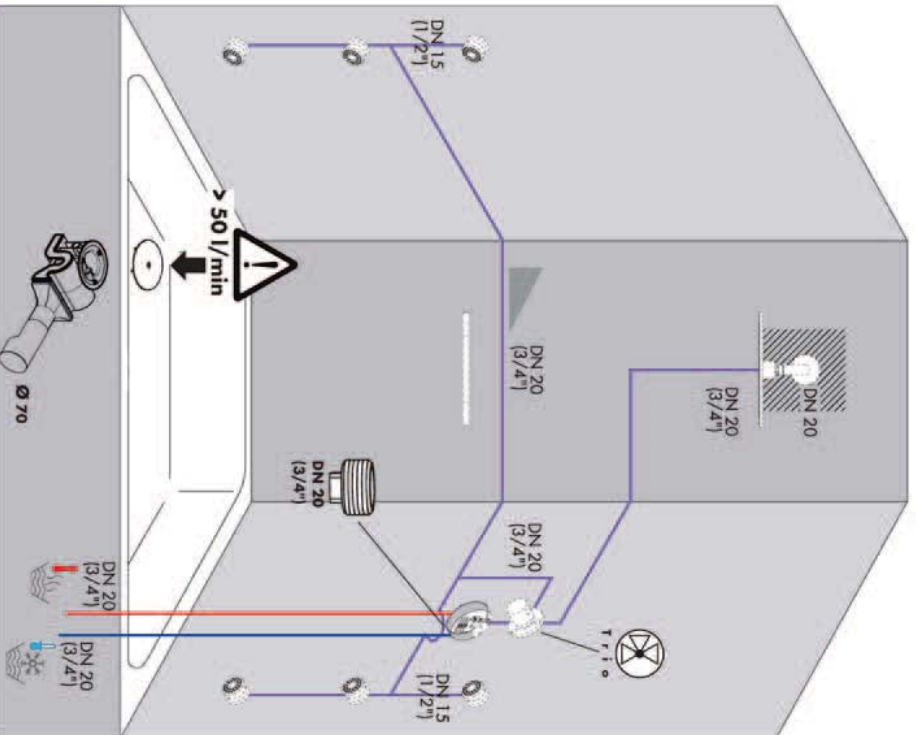



High
Flow

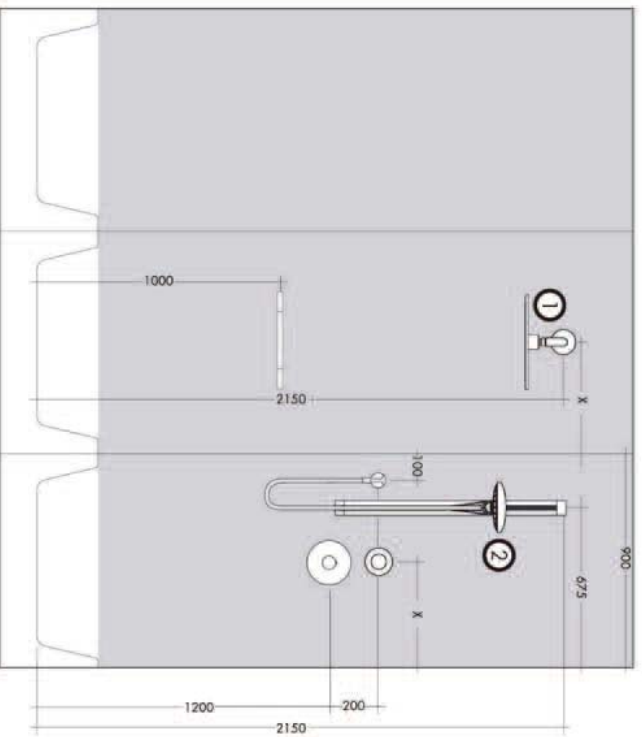
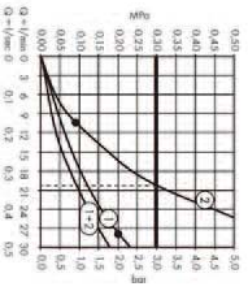

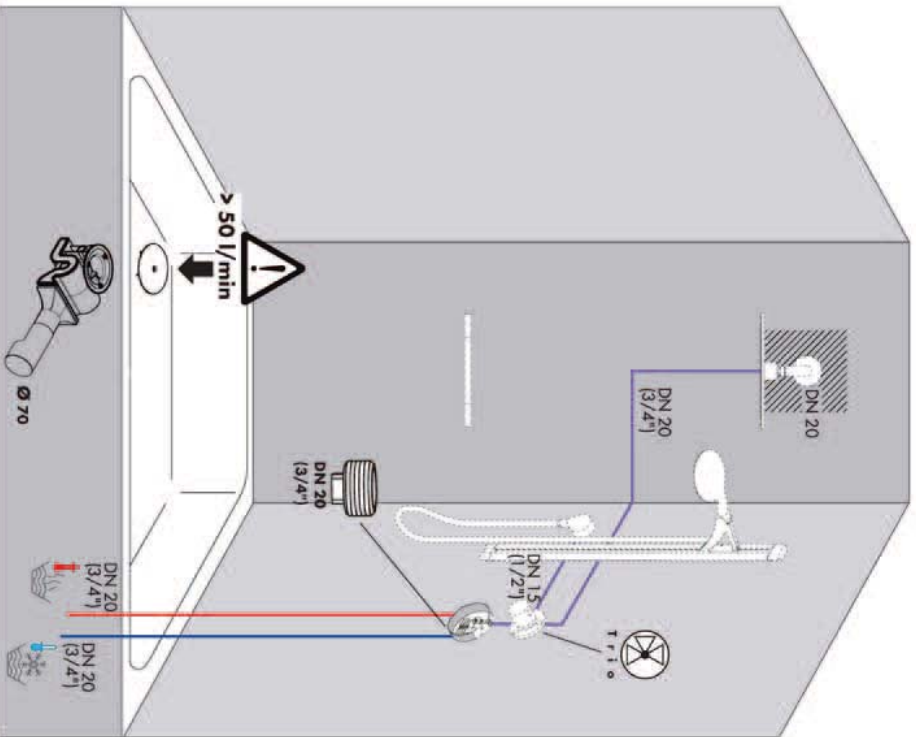



High
Flow

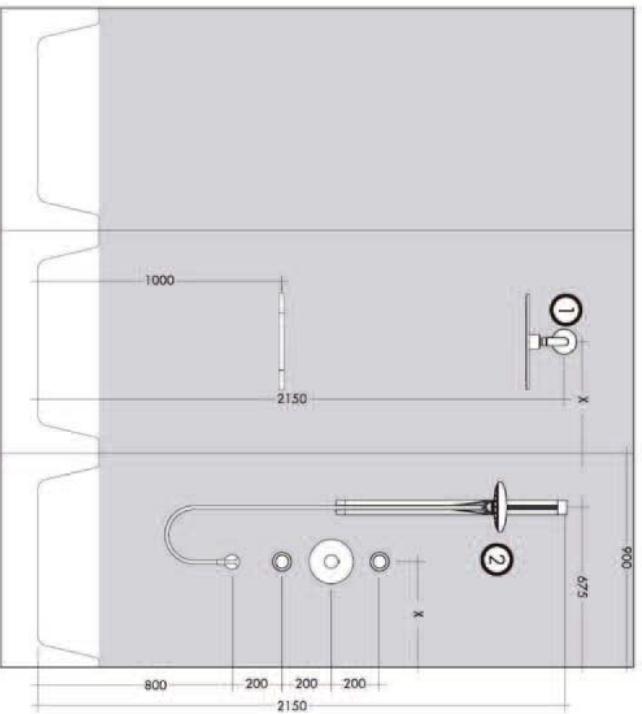
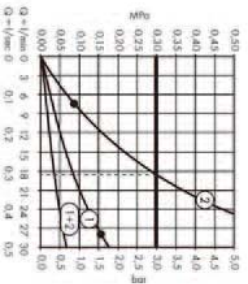

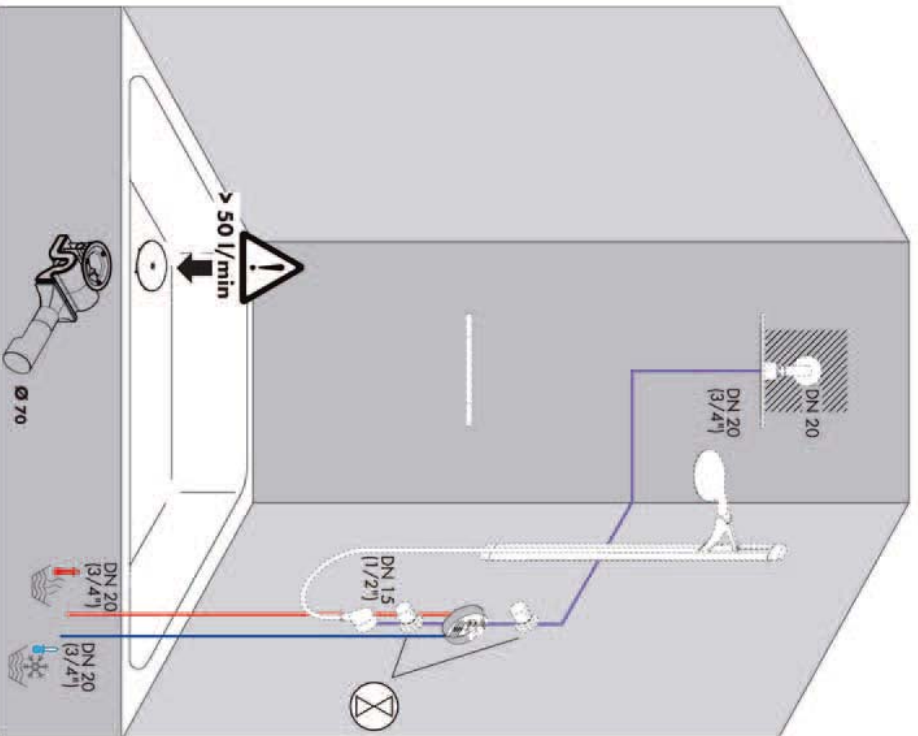

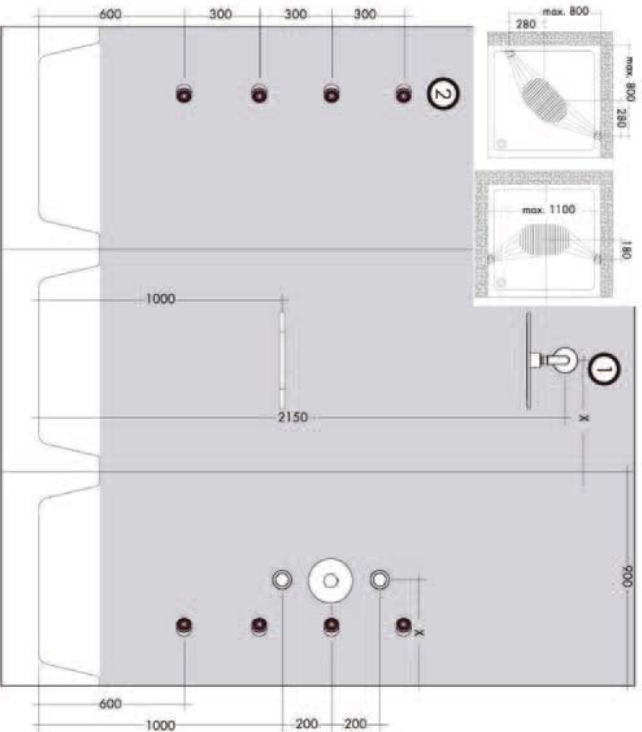
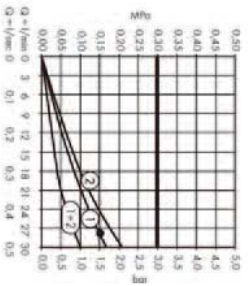

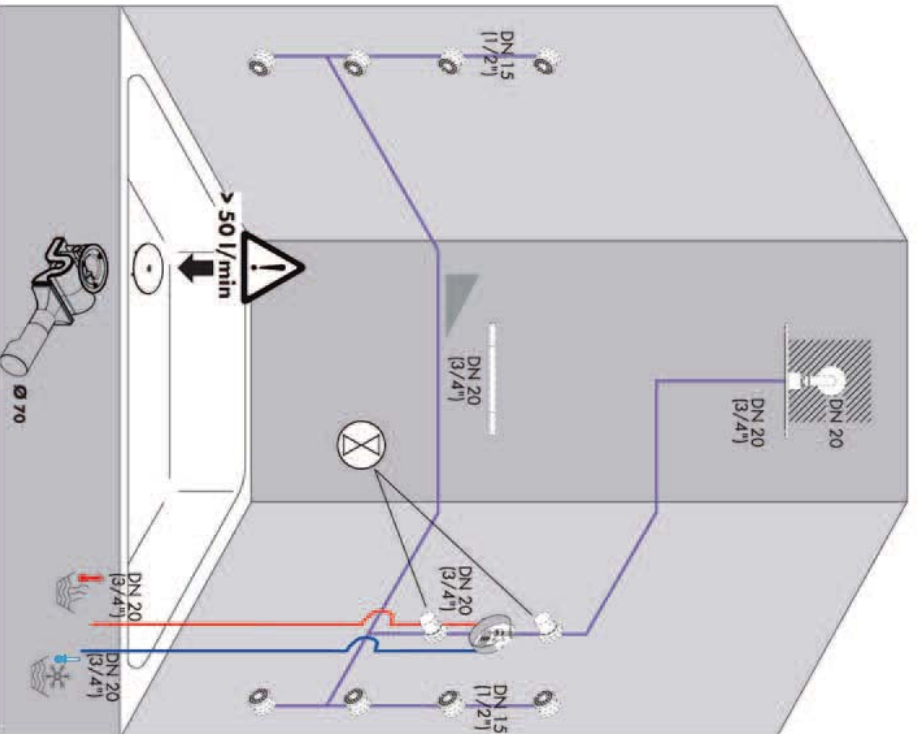



High
flow

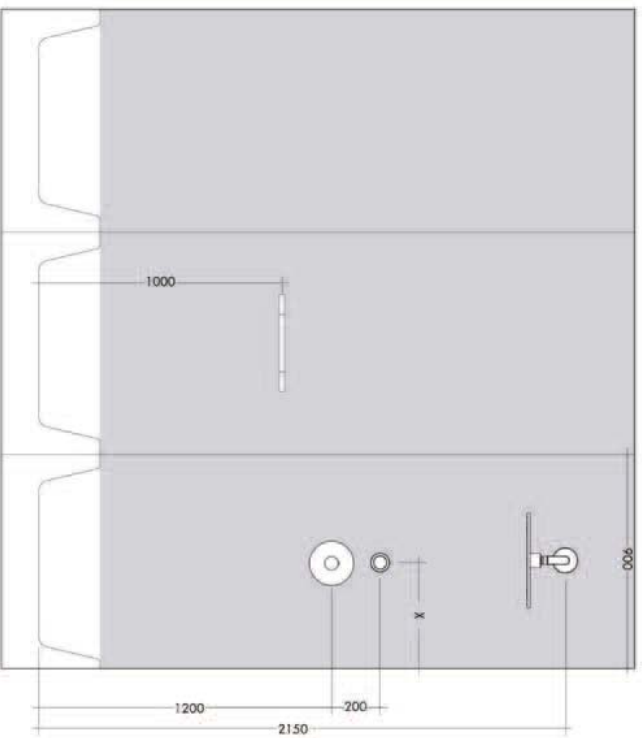
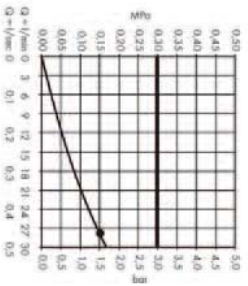

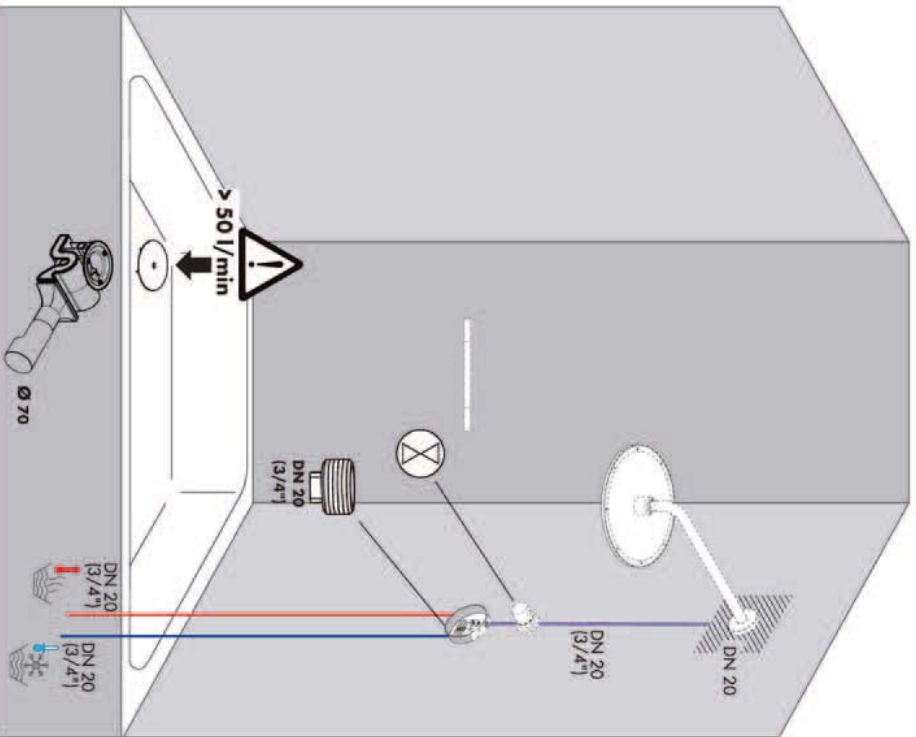

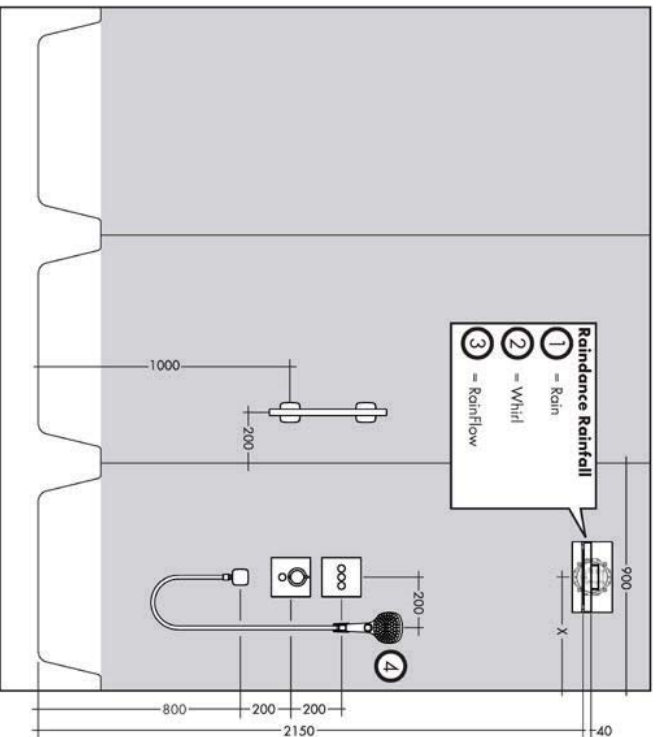
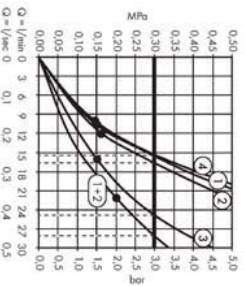

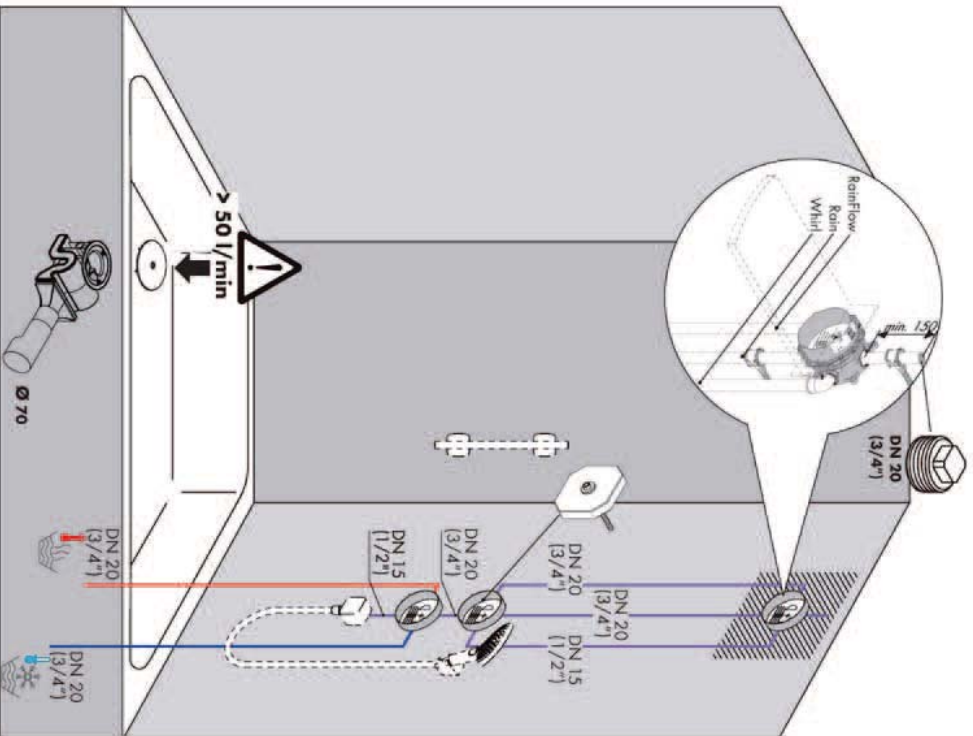



High
flow

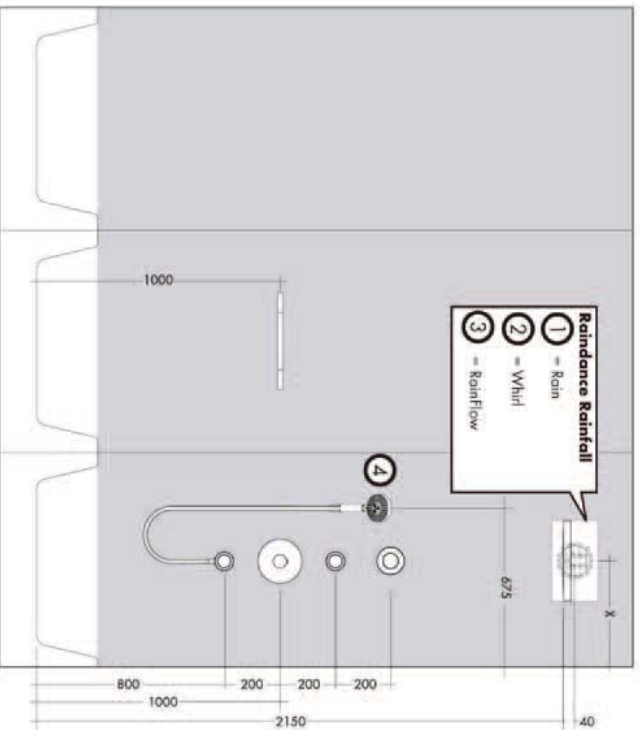
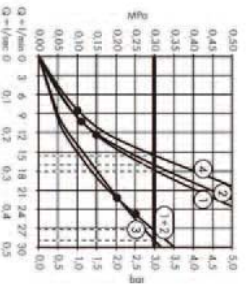

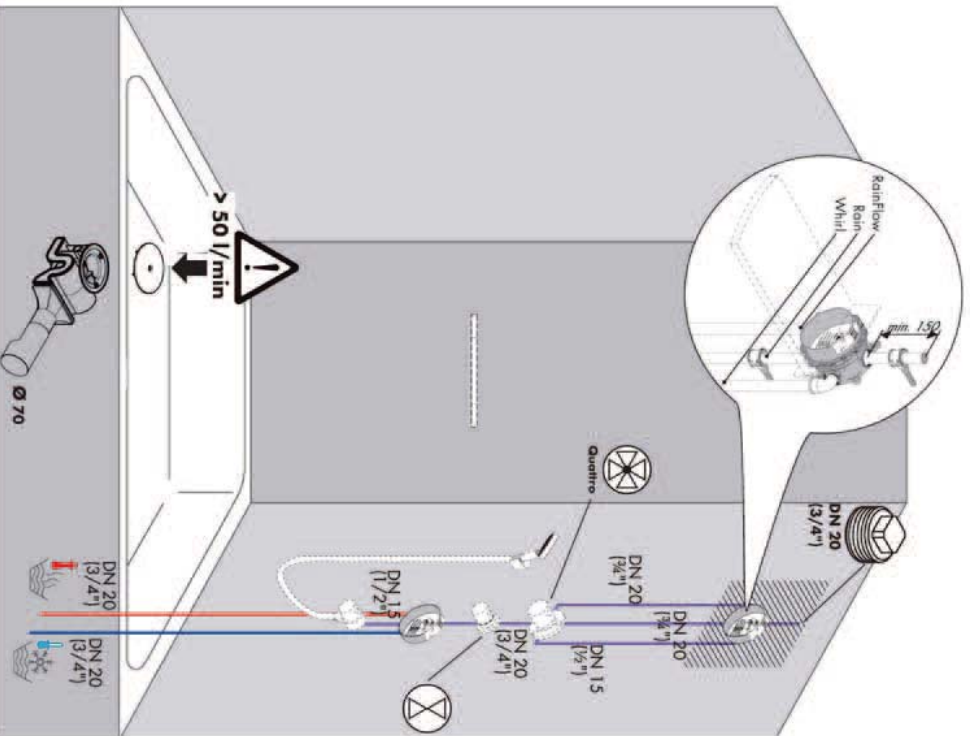

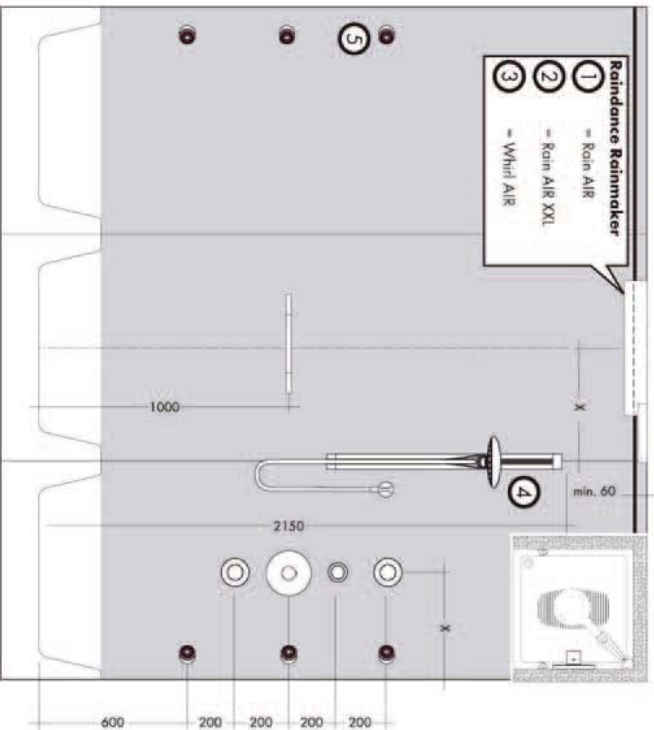
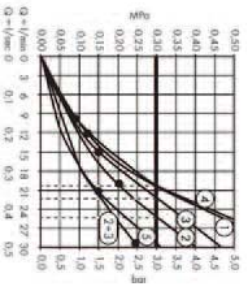

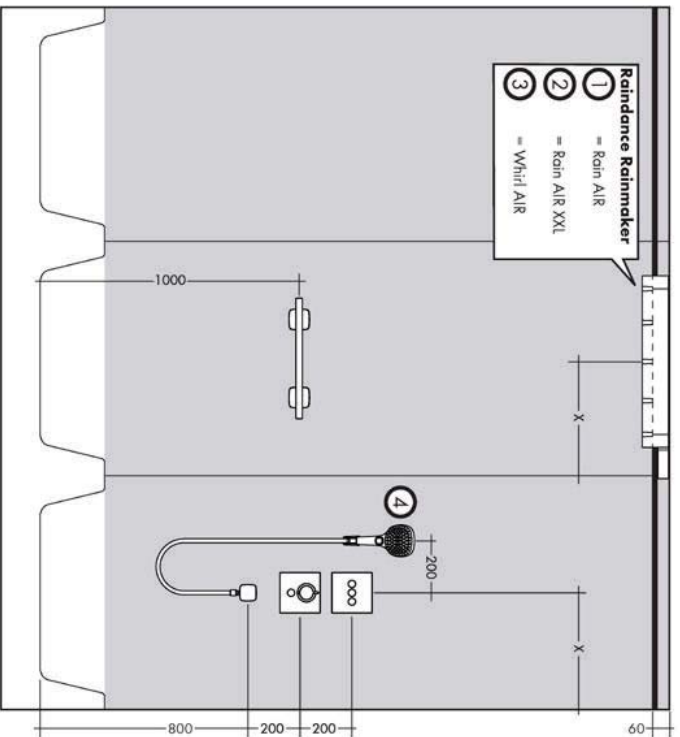
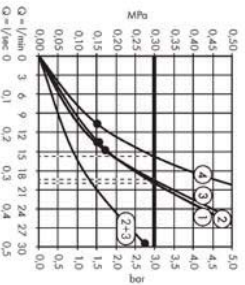

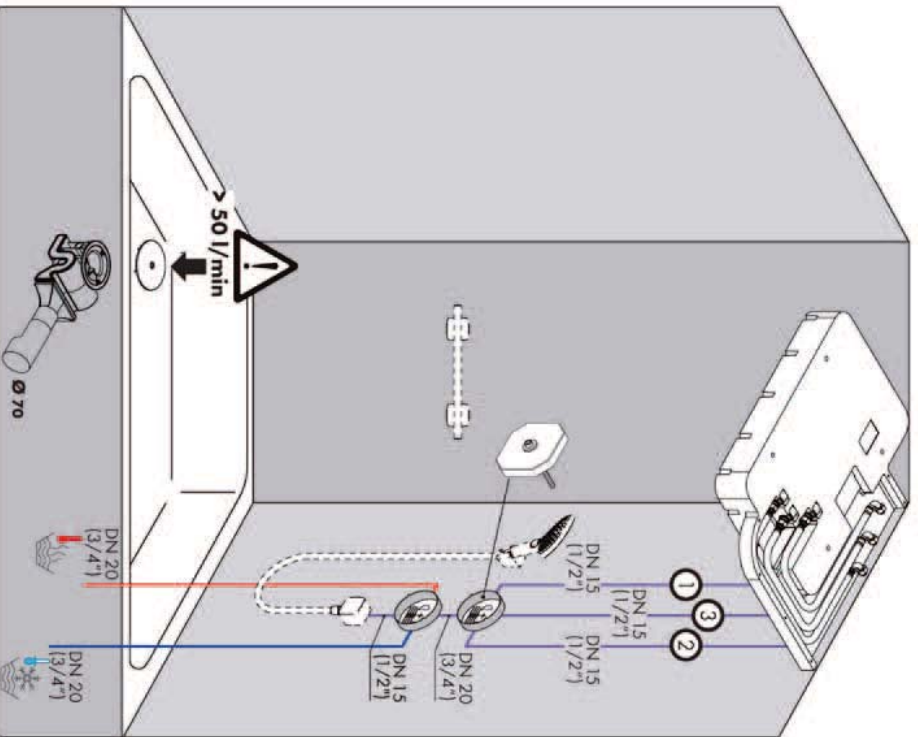

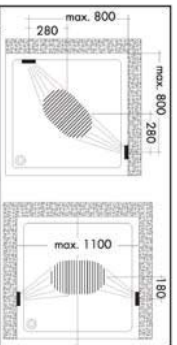
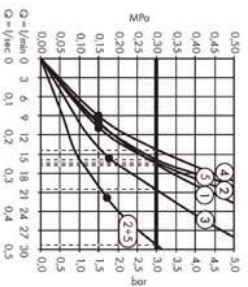
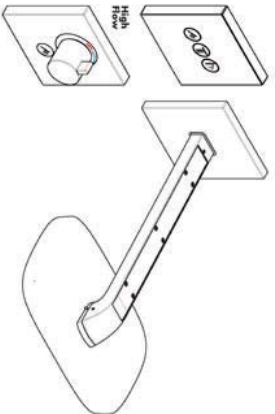

- Raindance Select 300**
- ① = Rain
 - ② = RainAir
 - ③ = RainStream

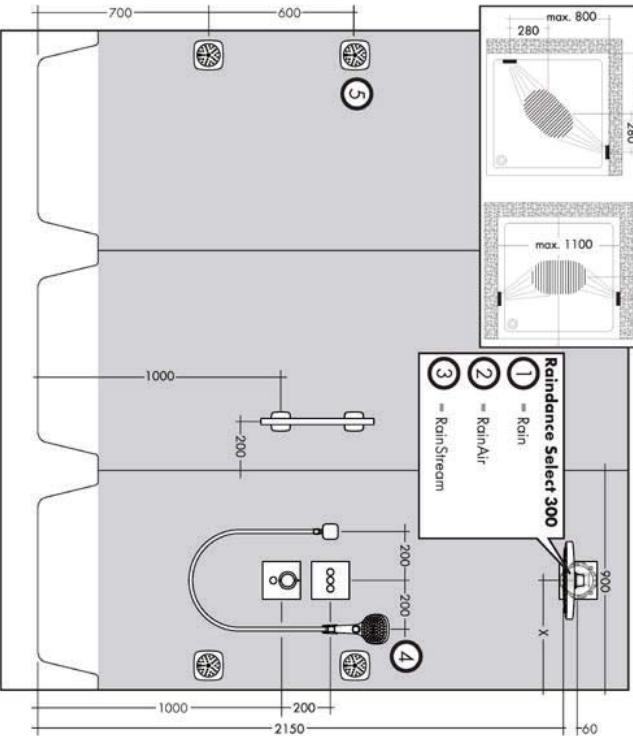

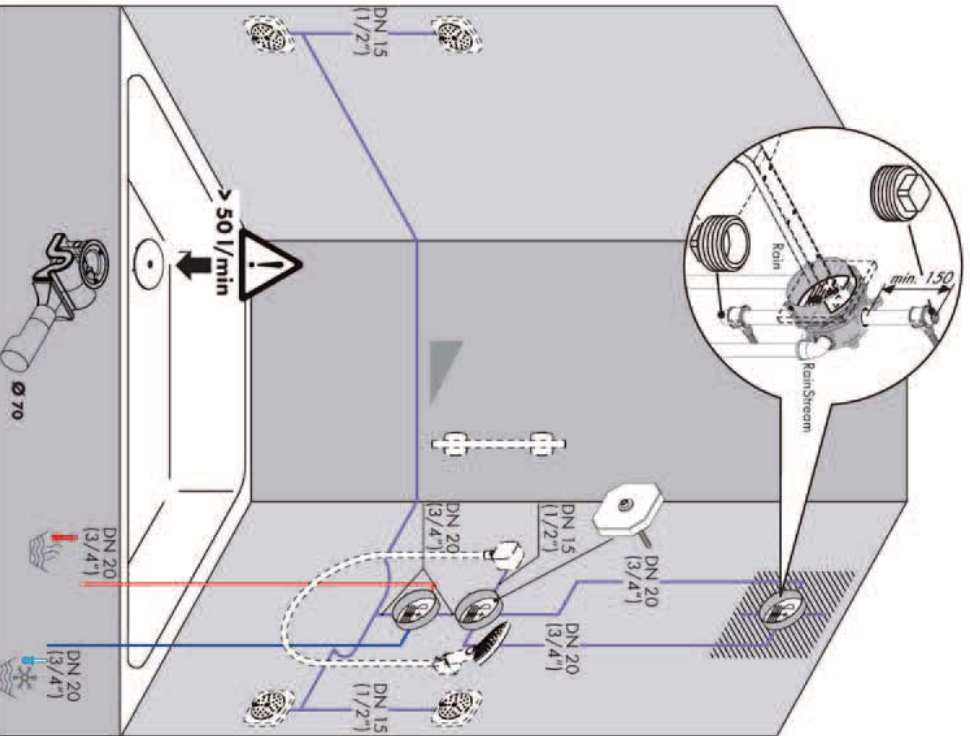

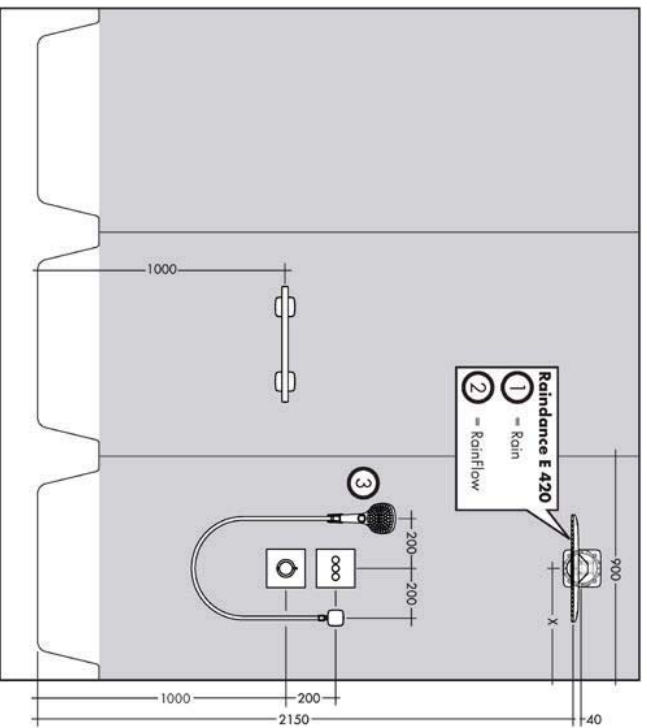
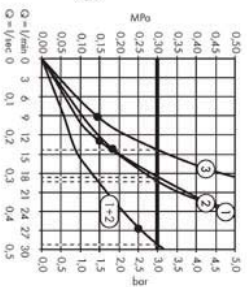
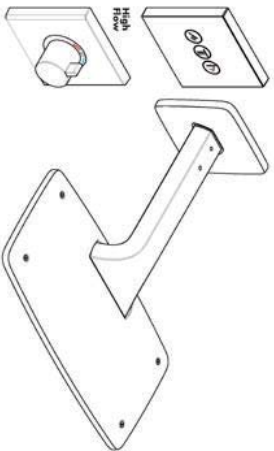

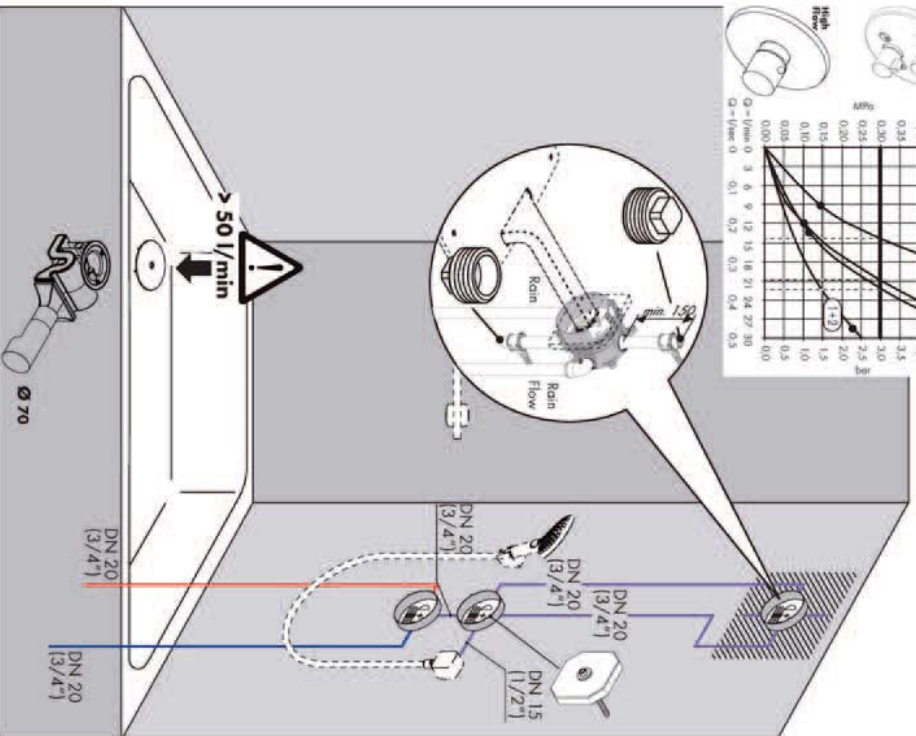
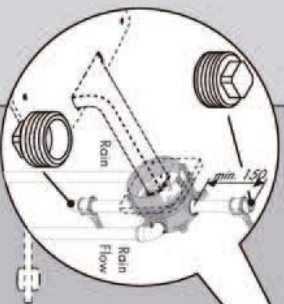
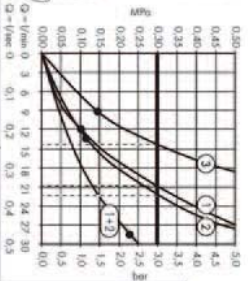

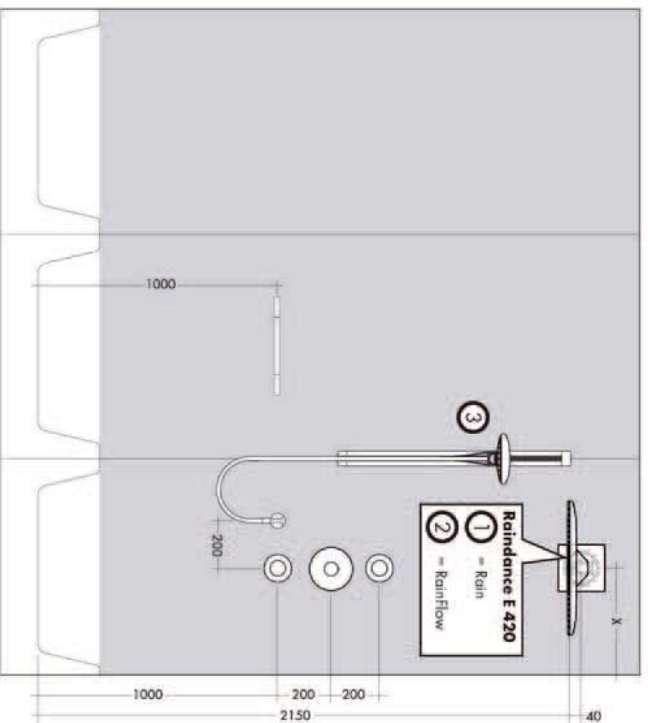
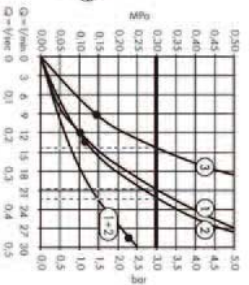
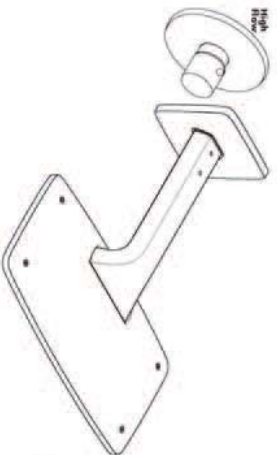

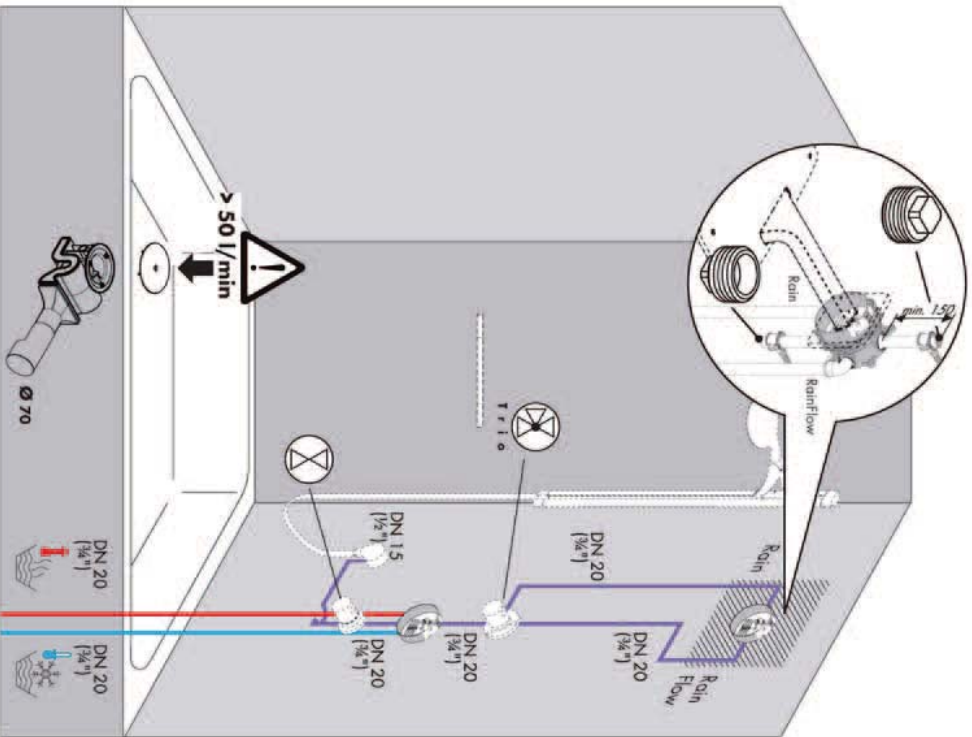

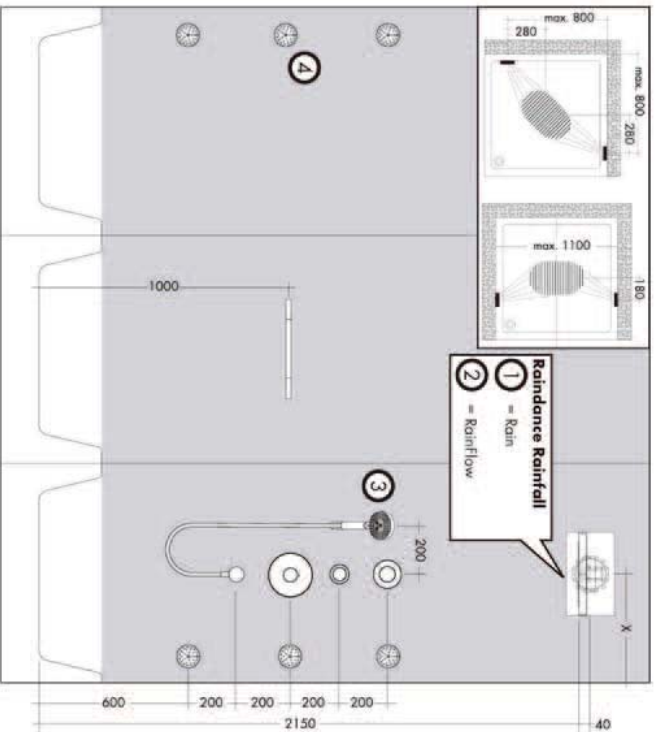
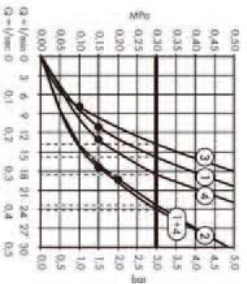

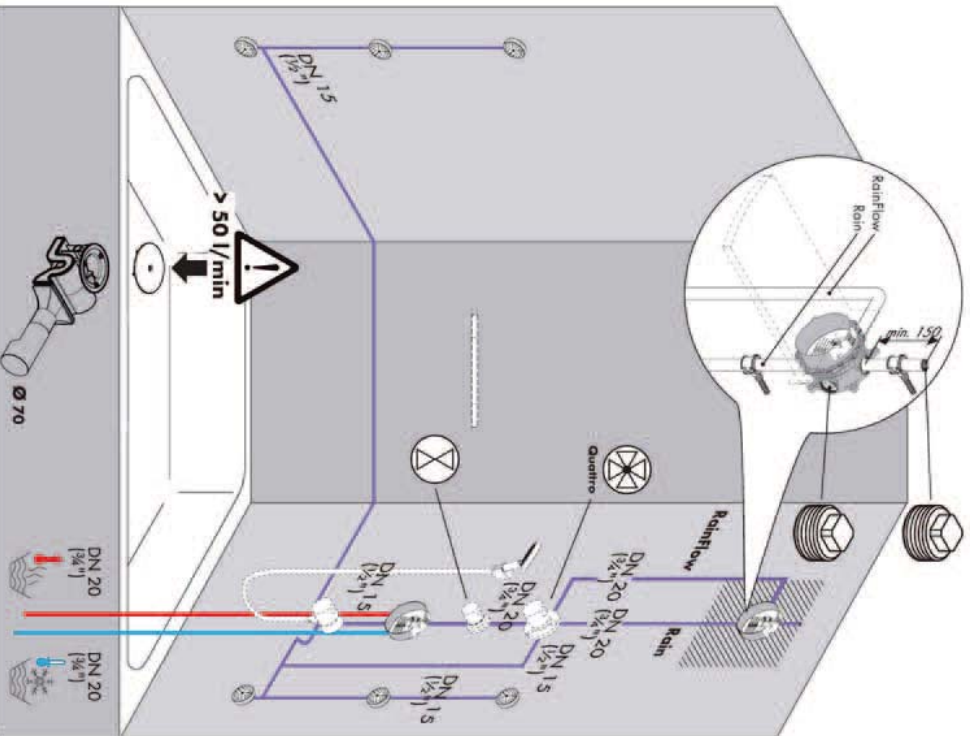



High Flow

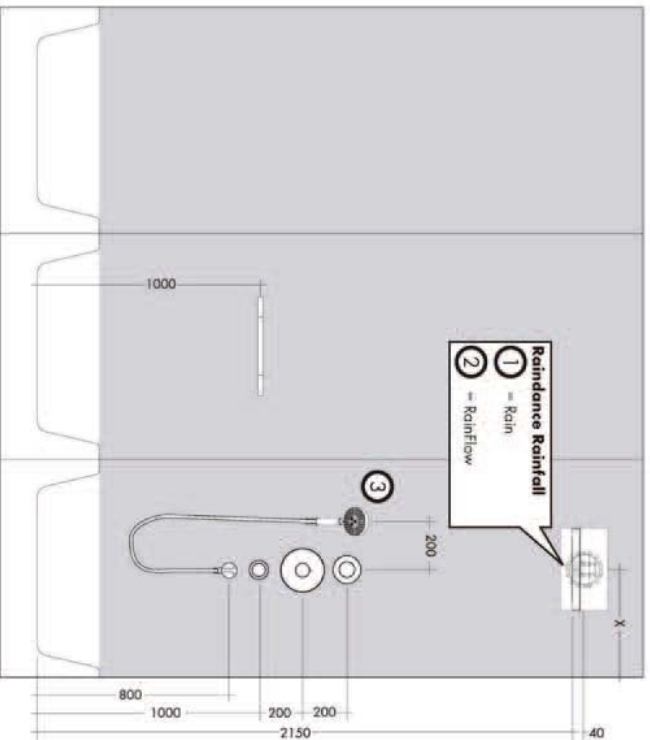
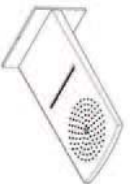
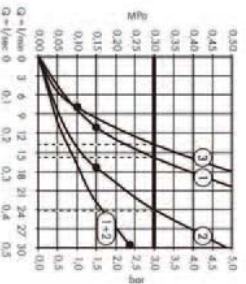

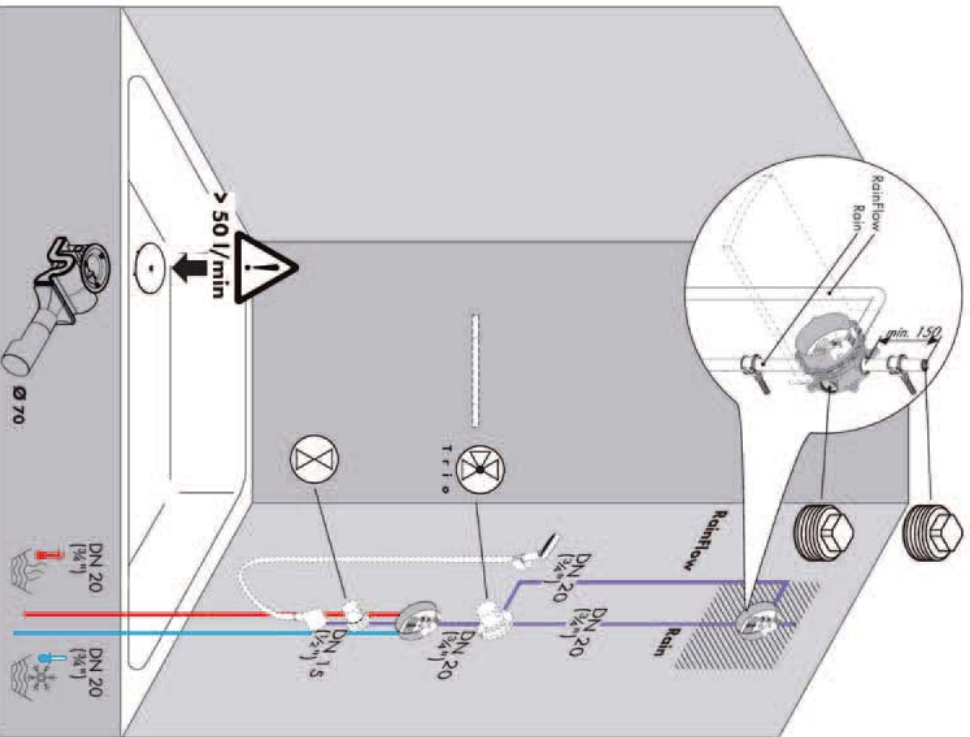

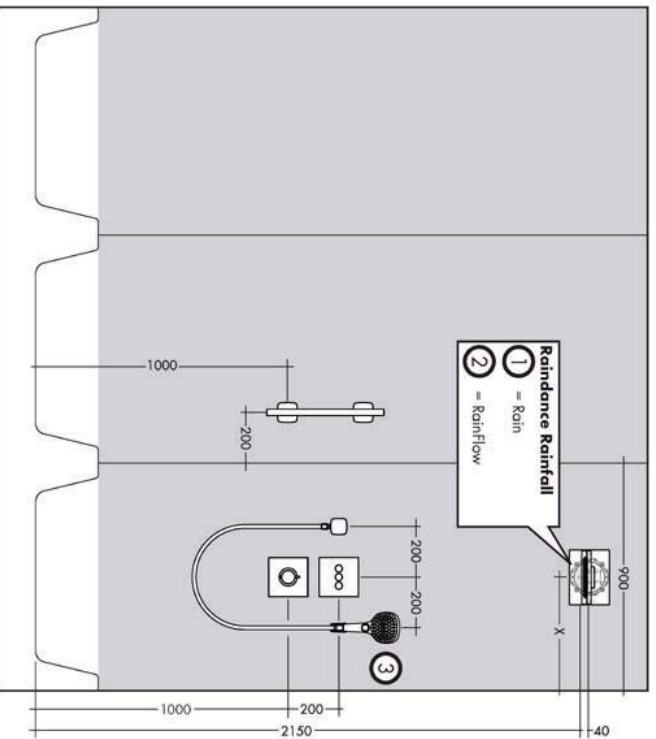
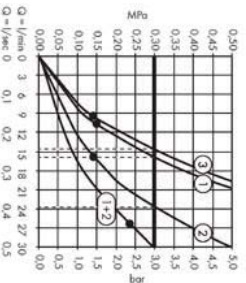

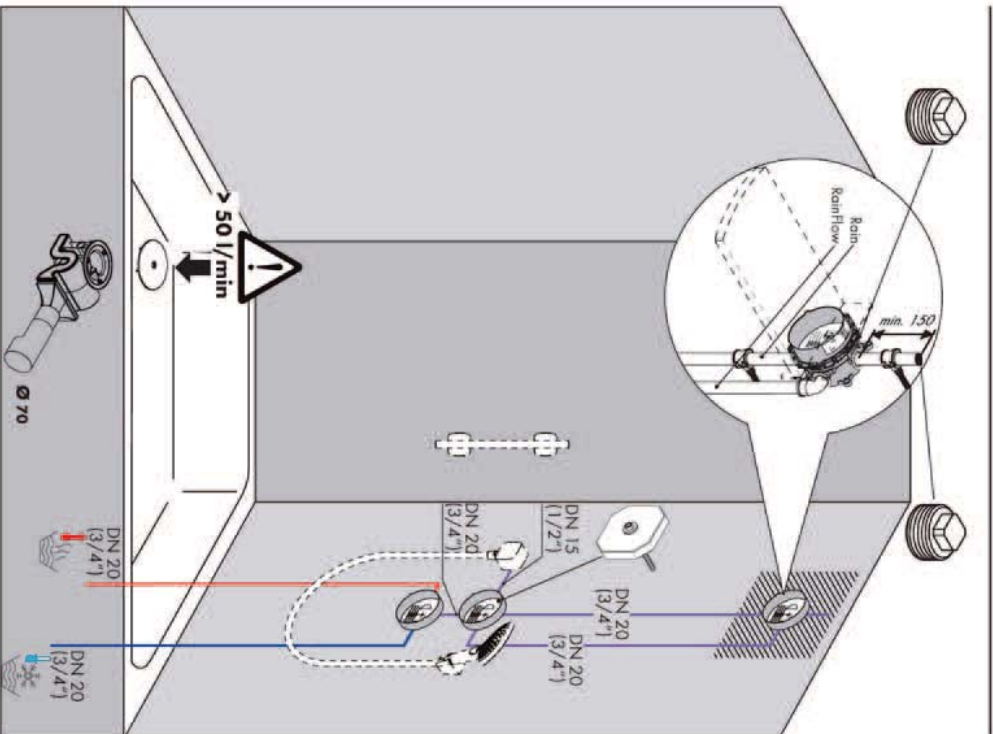

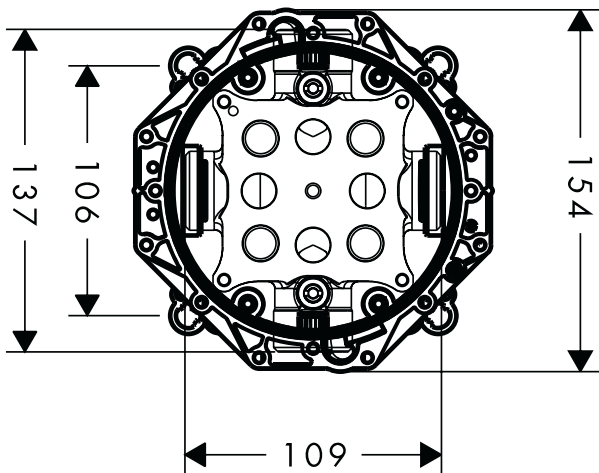
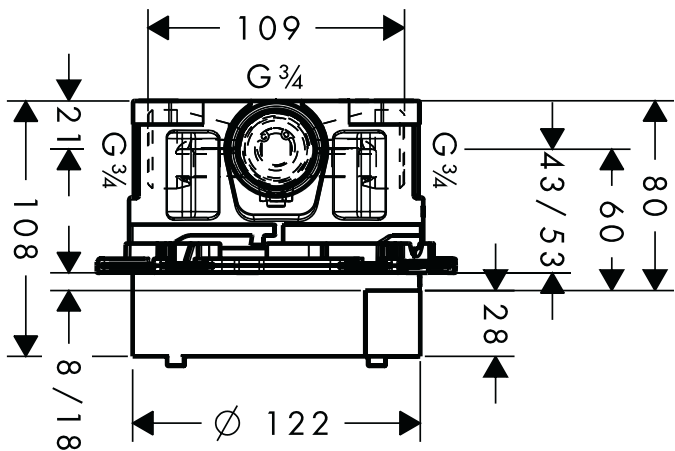

hansgrohe

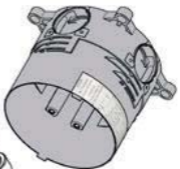

97759000



97739000

98797000

96445000

13595000

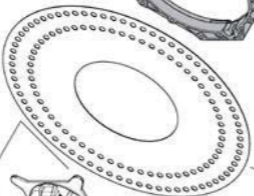

98119000

(9x2)

SW 5 mm

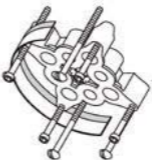

97611000

98560000



AXXOR®

hansgrohe

DE	Montageanleitung	2
FR	Instructions de montage	2
EN	assembly instructions	3
IT	Istruzioni per l'installazione	3
ES	Instrucciones de montaje	4
NL	Handleiding	4
DK	Monteringsvejledning	5
PT	Manual de Instalação	5
PL	Instrukcja montażu	6
CS	Montážní návod	6
SK	Montážny návod	7
ZH	组装说明	7
RU	Инструкция по монтажу	8
HU	Szerelési útmutató	8
FI	Asemusohje	9
SV	Monteringsanvisning	9
LT	Montavimo instrukcijos	10
HR	Uputstva za instalaciju	10
TR	Montaj kılavuzu	11
RO	Instrucțiuni de montare	11
EL	Οδηγία συναρμολόγησης	12
SL	Navodila za montažo	12
EI	Paiigaldusjuhend	13
LV	Montāžas instrukcija	13
SR	Uputstvo za montažu	14
NO	Montasjerveiledning	14
BG	Ръководство за монтаж	15
SG	Udhæizime greth montimit	15
AR	تعليمات التجميع	16

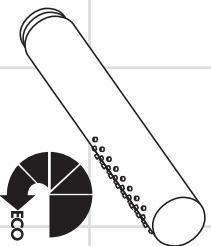

Starck
1 053 1000

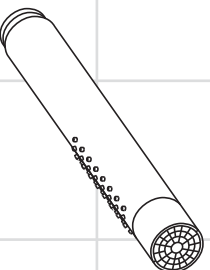

Starck
2 853 2000



Sicherheitshinweise

- ⚠ Der Kontakt der Brausestrahlen mit empfindlichen Körperstellen (z. B. Augen) muss vermieden werden. Es muss ein ausreichender Abstand zwischen Brause und Körper eingehalten werden.

Montage (siehe Seite 19)

Die der Brause beige packte Siebdichtung muss eingebaut werden, um Schmutzeinspülungen aus dem Leitungsnetz zu vermeiden. Schmutzeinspülungen können die Funktion beeinträchtigen und/oder zu Beschädigungen an Funktionsteilen der Brause führen, für hieraus ergebende Schäden haftet Hansgrohe nicht.

Reinigung (siehe Seite 20) und beiliegende Broschüre

Technische Daten

Betriebsdruck: max. 0,6 MPa
Empfohlener Betriebsdruck: 0,1 - 0,4 MPa
(1 MPa = 10 bar = 147 PSI)
Heißwassertemperatur: max. 60°C
Thermische Desinfektion:
max. 70°C / 4 min

Prüfzeichen (siehe Seite 17)

Serviceteile (siehe Seite 19)



Consignes de sécurité

- ⚠ Éviter le contact du jet de la douche avec les parties sensibles du corps (telles par ex. que les yeux). Veiller à respecter un écart suffisant entre la douche et le corps

Montage (voir page 19)

Le joint à filtre fourni avec la pomme de douche à main doit être installé afin de retenir des impuretés du système de conduites. Ceux-ci pourraient influencer le fonctionnement de ce produit et même endommager des pièces mobiles. Des réclamations à la suite de l'usage de la pomme de douche sans joint-tamis de hansgrohe ne peuvent pas faire partie de notre garantie.

Nettoyage (voir page 20) et brochure ci-jointe

Informations techniques

Pression de service autorisée: max. 0,6 MPa
Pression de service conseillée: 0,1 - 0,4 MPa
(1 MPa = 10 bar = 147 PSI)
Température d'eau chaude: max. 60°C
Désinfection thermique:
max. 70°C / 4 min

Classification acoustique et

débit (voir page 17)

Pièces détachées (voir pages 19)

**Safety Notes**

- ⚠ Do not allow the streams of the shower touch sensitive body parts (such as your eyes). An adequate distance must be kept between the shower and you.

**Indicazioni sulla sicurezza**

- ⚠ Bisogna evitare il contatto fra il getto della doccia e parti del corpo delicate (ad es. gli occhi). Fra il soffione ed il corpo va mantenuta una distanza sufficiente.

Assembly (see page 19)

The mesh washer must be inserted to protect the overhead shower against incoming dirt by pipework. Incoming dirt leads to defects or/and can damage parts of the shower; such caused faults voids all liability and guarantee claims.

Cleaning (see page 20) and enclosed brochure

Technical Data

Operating pressure: max. 0,6 MPa
Recommended operating pressure: 0,1 - 0,4 MPa
(1 MPa = 10 bar = 147 PSI)
Hot water temperature: max. 60 °C
Thermal disinfection: max. 70 °C / 4 min

Test certificate (see page 17)

Spare parts (see page 19)

Montaggio (vedi pagg. 19)

Per proteggere la soffione doccia da eventuali impurità provenienti dalle tubazioni dell'acqua, deve essere inserito il filtro nell'impugnatura della doccia stessa. Tali impurità possono infatti causare difetti e/o danneggiare parti della doccia; in questo caso la Hansgrohe non risponde dei danni.
Pulitura (vedi pagg. 20) e brochure allegata

Dati tecnici

Pressione d'uso: max. 0,6 MPa
Pressione d'uso consigliata: 0,1 - 0,4 MPa
(1 MPa = 10 bar = 147 PSI)
Temperatura dell'acqua calda: max. 60 °C
Disinfezione termica: max. 70 °C / 4 min

Segno di verifica (vedi pagg. 17)

Parti di ricambio (vedi pagg. 19)

**Indicaciones de seguridad**

- ⚠ Debe evitarse el contacto del chorro del pulverizador con partes sensibles del cuerpo (por ej. ojos). Debe mantenerse una distancia suficiente entre pulverizador y cuerpo.

**Veiligheidsinstructies**

- ⚠ Het contact van de douchestraal met gevoelige lichaamsdelen (bijv. ogen) moet worden voorkomen. Er moet voldoende afstand tussen douche en lichaam aangehouden worden.

Montaje (ver página 19)

La junta de filtración que se suministra con la ducha mural evita que las partículas de suciedad procedentes de las tuberías lleguen a la ducha mural. Debe colocarse entre el flexo y la ducha mural. Infiltraciones de suciedad deterioran el funcionamiento de la ducha mural y pueden causar daños en el interior de la misma que no están cubiertas por la garantía de Hansgrohe.

Montage (zie blz. 19)

Het bij de hoofddouche verpakte zeefje moet worden ingebouwd om vuil uit de waterleiding te weren. Vuil uit de leidingen kan de werking van de hoofddouche negatief beïnvloeden en/of de hoofddouche beschadigen. Voor deze schade is Hansgrohe niet verantwoordelijk.

Limpiar (ver página 20) y folleto anexo**Datos técnicos**

Presión en servicio: max. 0,6 MPa
Presión recomendada en servicio: 0,1 - 0,4 MPa
(1 MPa = 10 bar = 147 PSI)
Temperatura del agua caliente: max. 60 °C
Desinfección térmica: max. 70 °C / 4 min

Marca de verificación (ver página 17)

Repuestos (ver página 19)

Technische gegevens

Werkdruk: max. 0,6 MPa
Aanbevolen werkdruk: 0,1 - 0,4 MPa
(1 MPa = 10 bar = 147 PSI)
Temperatuur warm water: max. 60 °C
Thermische desinfectie: max. 70 °C / 4 min

Keurmerk (zie blz. 17)

Service onderdelen (zie blz. 19)



Sikkerhedsanvisninger

- △ Bruserstrålets kontakt med sensitive områder (f.eks. øjne) skal undgås. Der skal være en tilstrækkelig afstand mellem bruseren og kroppen.

Montering (se s. 19)

Den vedlagte smudsfangssi skal indsættes i bruseren for at undgå snovs fra rørsystemet. Indskyllet snovs kan have indflydelse på bruserens funktion og/eller føre til beskadigelser på håndbruserens funktionsdele.

Rengøring (se s. 20) og vedlagt brochure

Tekniske data

Driftstryk: max. 0,6 MPa
 Anbefalet driftstryk: 0,1 - 0,4 MPa
 (1 MPa = 10 bar = 147 PSI)
 Varmvandstemperatur: max. 60°C
 Termisk desinfektion:
 max. 70°C / 4 min

Godkendelse (se s. 17)

Reserve dele (se s. 19)



Avisos de segurança

- △ Devese evitar o contacto dos jactos de água com partes do corpo sensíveis (p. ex. olhos). É necessário manter uma distância suficiente entre o chuveiro e o corpo.

Montagem (ver página 19)

O filtro de rede deve ser colocado para proteger o chuveiro de areias e resíduos provenientes da tubagem. Resíduos e areias podem danificar componentes, ou provocar mau funcionamento do chuveiro; as avarias assim provocadas anulam a nossa responsabilidade e anulam a nossa garantia.

Limpeza (ver página 20) e brochure em anexo

Dados Técnicos

Pressão de funcionamento: max. 0,6 MPa
 Pressão de func. recomendada: 0,1 - 0,4 MPa
 (1 MPa = 10 bar = 147 PSI)
 Temperatura da água quente: max. 60°C
 Desinfecção térmica:
 max. 70°C / 4 min

Marca de controlo (ver página 17)

Peças de substituição (ver página 19)



Wskazówki bezpieczeństwa

- ⚠ Należy unikać kontaktu strumienia wypływającego z głowicy z wrażliwymi częściami ciała (np. oczami). Należy zachowywać odpowiednią odległość pomiędzy głowicą a ciałem.

Montaż (patrz strona 19)

Znajdujące się przy przysznicu siłko musi zostać zainstalowane, aby zatrzymać zanieczyszczenia z instalacji. Przedostające się zanieczyszczenia mogą mieć ujemny wpływ na działanie i/lub prowadzić do usierek w działaniu elementów przysznica. Za powstałe z tego tytułu szkody firma Hansgrohe nie ponosi odpowiedzialności.

Czyszczenie (patrz strona 20) i dotychczas broszura

Dane techniczne

Cisnienie robocze: maks. 0,6 MPa
Zalecane ciśnienie robocze: 0,1 - 0,4 MPa
(1 MPa = 10 bary = 147 PSI)
Temperatura wody
gorącej: maks. 60 °C
Dezynfekcja
termiczna: maks. 70 °C / 4 min

Znak jakości (patrz strona 17)

Części serwisowe (patrz strona 19)



Bezpečnostní pokyny

- ⚠ Je nutné zabránit kontaktu vodních paprsků sprchy s měkkými částmi těla (např. očima). Je nutné dodržovat dostatečný odstup mezi sprchou a tělem.

Montáž (viz strana 19)

Do přívodu musí být zabudováno se sprchou dodávané sítko, aby zachycovalo nečistoty vyplavené z vodovodní sítě. Vyplavené nečistoty mohou ovlivnit funkci sprchy a nebo mohou vést i k jejímu poškození. Na takto vzniklé škody se nevztahuje záruka firmy Hansgrohe.

Čištění (viz strana 20) a příložená brožura

Technické údaje

Provozní tlak: max. 0,6 MPa
Doporučený provozní tlak: 0,1 - 0,4 MPa
(1 MPa = 10 bar = 147 PSI)
Teplota horké vody: max. 60 °C
Tepelná desinfekce: max. 70 °C / 4 min
Zkušební značka (viz strana 17)
Servisní díly (viz strana 19)



Bezpečnostné pokyny

- △ Vyhýbajte sa kontaktu vodného lúča sprchy s citlivými miestami tela (napr. očí). Dodržiavajte dostatočnú vzdialenosť medzi sprchou a telom.

Montáž (viď strana 19)

Do prívodu musí byť zabudované so sprchou dodávané sítko, aby zachytilo nečistoty vyplavené z vodovodnej siete. Vypravené nečistoty môžu ovlivniť funkciu sprchy, alebo spôsobiť jej poškodenie. Na takto vzniknuté škody sa nevzťahuje záruka firmy Hansgrohe.

Čistenie (viď strana 20) a príložená brožúra

Technické údaje

Prevádzkový tlak: max. 0,6 MPa
 Doporučený prevádzkový tlak: 0,1 - 0,4 MPa
 (1 MPa = 10 bar = 147 PSI)
 Teplota teplej vody: max. 60 °C
 Termická dezinfekcia:
 max. 70 °C / 4 min

Osvedčenie o skúške

(viď strana 17)

Servisné diely (viď strana 19)



安全技巧

- △ 必须避免让身体敏感部位（如眼睛）接触到莲蓬头喷水。必须保持莲蓬头与人头之间有足够的距离。

安装 (参见第 19 页)

必须装上花洒所附带的滤网密封垫，以过滤管道里的杂质污物。杂质污物会影响花洒的功能和/或损坏花洒的功能部件，由此而产生的产品损坏不属于汉斯格雅的保护范围。

清洗 (参见第 20 页) 并附有手册

技术参数

工作压力: 最大 0,6 MPa
 推荐工作压力: 0,1 - 0,4 MPa
 (1 MPa = 10 bar = 147 PSI)
 热水温度: 最大 60 °C
 热力消毒: 最大 70 °C / 4 分钟
检验标记 (参见第 17 页)
 备用零件 (参见第 19 页)

**Указания по технике безопасности**

- ⚠ Не допускайте попадания струи воды из разбрызгивателя на чувствительные части тела (например, на глаза).
- Разбрызгиватель следует устанавливать на достаточном расстоянии от тела.

Монтаж (см. стр. 19)

Для предотвращения попадания частиц грязи из водопроводной сети необходимо установить фильтр, прилагаемый к ручному душу.

Частицы грязи могут нарушить отдельные функции и/или привести к повреждению функциональных деталей ручного душа, Hansgrohe не несет ответственность за повреждение вследствие отсутствия фильтра.

Очистка (см. стр. 20) и прилагаемая брошюра

Технические данные

Рабочее давление: не более. 0,6 МПа
Рекомендуемое рабочее давление: 0,1 - 0,4 МПа
(1 МПа = 10 bar = 147 PSI)

Температура горячей воды: не более. 60 °C
Термическая дезинфекция: не более. 70 °C / 4 мин

Знак технического контроля
(см. стр. 17)

Комплект (см. стр. 19)

8

**Biztonsági utasítások**

- ⚠ Kerülni kell a zuhanysugár érintkezését érzékeny testrészekkel (pl. szemek). Be kell tartani a megfelelő távolságot a zuhanylej és a test között.

Szerelés (lásd a 19. oldalon)

A kézi zuhanlhoz csomagolt szűrőtömlőst be kell szerelni a vízhálózatról származó szemvezetékek kiküszöbölésére. A beáramló szemvezetékek akadályozhatják és / vagy teljesen tönkre is tehetik a zuhanu funkcióit. Az ezekből adódó károkat a Hansgrohe nem felel.

Tisztítás (lásd a 20. oldalon) és mellékelt broszúrával

Műszaki adatok

Üzemi nyomás: max. 0,6 МПа
Ajánlott üzemi nyomás: 0,1 - 0,4 МПа
(1 МПа = 10 bar = 147 PSI)

Forróvíz hőmérséklet: max. 60 °C
Termikus fertőtlenítés:

max. 70 °C / 4 perc

Vizsgajel (lásd a 17. oldalon)

Tartozékok (lásd a 19. oldalon)

**Turvallisuusohjeet**

- △ Suihkuveden kontaktia herkkien ruumiinosien (esim. silmien) kanssa on vältettävä. Suihkun ja vartalon välissä on oltava riittävä väli.

Asennus (katso sivu 19)

Käsisuihkun mukana toimitettu sihtitiiviste on asennettava paikalleen, jotta lian huuhoutuminen vesijohtoverkostosta käsisuihkuun estyy. Huuhoutuvat likahukkaset voivat häiritä suihkun toimintaa tai vahingoittaa toimintaosia, Hansgrohe ei vastaa tästä aiheutuneista vahingoista.

Puhdistus (katso sivu 20) ja

ohainen esite

Tekniset tiedot

Käyttöpaino: maks. 0,6 MPa
Suositeltu käyttöpaino: 0,1 - 0,4 MPa
(1 MPa = 10 bar = 147 PSI)
Kuuman veden lämpötila: maks. 60 °C
Lämpödesinfektio: maks. 70 °C / 4 min

Koestusmerkki (katso sivu 17)**Varaosat** (katso sivu 19)**Säkerhetsanvisningar**

- △ Undvik att rika duschstrålarna mot känsliga kroppsdelar (t. ex. ögonen). Det måste finnas ett tillräckligt stort avstånd mellan duschen och kroppen.

Montering (se sidan 19)

Silpackningen som följer med duschen måste monteras för att undvika att smuts från ledningsröret tränger in. Smuts som spolas in kan påverka funktionerna och/eller leda till skador på funktionsdelar i duschen. Hansgrohe fransäger sig allt ansvar för skador som kan härledas till detta.

Rengöring (se sidan 20) och medföljande broschyr

Tekniska data

Driftstryck: max. 0,6 MPa
Rek. driftstryck: 0,1 - 0,4 MPa
(1 MPa = 10 bar = 147 PSI)
Yrmyvattentemperatur: max. 60 °C
Termisk desinfektion: max. 70 °C / 4 min

Testsigill (se sidan 17)**Reservdelar** (se sidan 19)

**Saugumo technikos nurodymai**

- ⚠ Būitina vengti dušo vandens srovės kontakto su jautriomis kūno vietomis (pvz., akimis). Todėl būitina laikytis tinkamu atstumu nuo dušo.

Montavimas (žr. psl. 19)

Tinklelis, kuris yra rankų dušas pakuoėje, privalo būti įstaiytas, kad būtų apsaugota nuo išorės nešvarumų. Nešvarumai gali pakenkti rankų dušas funkcionalumui ir (arba) sugadinti rankų dušas funkcines dalis. Tokiu atveju „Hansgrohe“ atsakomybės neprišima.

Valymas (žr. psl. 20) ir pridėjama brošiūra

Techniniai duomenys

Darbinis slėgis:

ne daugiau kaip 0,6 MPa
Rekomenduojamas slėgis: 0,1 - 0,4 MPa
(1 MPa = 10 barų = 147 PSI)

Karšio vandens

temperatūra: ne daugiau kaip 60°C
Terminis dezinfekavimas:

ne daugiau kaip 70°C / 4 min

Bandymo pažyma (žr. psl. 17)

Atsarginės dalys (žr. psl. 19)

**Sigurnosne upute**

- ⚠ Mora se izbjegavati kontakt mlaza iz tuša s osjetljivim dijelovima tijela (npr. očima). Tijelo korisnika mora biti dovoljno udaljeno od tuša.

Sastavijanje (pogledaj stranicu 19)

Filter potrebno je ugraditi kako bi se regulirao protok vode i smanjio dotok prljavštine. Za eventualna oštećenja uzrokovana prljavštinom proizvođač Hansgrohe nije odgovoran.

Čišćenje (pogledaj stranicu 20) i priložena brošiura

Tehnički podatci

Najveći dopušteni tlak: tlak 0,6 MPa
Preporučeni tlak: 0,1 - 0,4 MPa
(1 MPa = 10 bar = 147 PSI)

Temperatura vruće vode: tlak 60°C

Termička dezinfekcija:

tlak 70°C / 4 min

Oznaka testiranja

(pogledaj stranicu 17)

Rezerwni dijelovi

(pogledaj stranicu 19)



Güvenlik uyarıları

- ⚠ Püskürtme başlıklarının hassas organlara teması (örn. gözler) önlenmelidir. Püskürtücü ile beden arasında yeterli mesafe bırakılmalıdır.

Montajı (Bakınız sayfa 19)

El duşu kafasına eklenmiş olan süzgeç contası, boru şebekesinden sızan kirlerin önüne geçmek için, yerine monte edilmelidir. İçeri sızan bu kirler duşun fonksiyonunu sekteleyebilir ve/veya duşun fonksiyon parçaları üzerinde hasarlara sebep olabilir, bu yüzden meydana gelen hasarlardan Hansgrohe sorumlu tutulamaz.

Temizleme (Bakınız sayfa 20) ve

birlikte verilen broşür

Teknik bilgiler

İşletme basıncı: azami 0,6 MPa
Tavsîye edilen işletme basıncı: 0,1 - 0,4 MPa
(1 MPa = 10 bar = 147 PSI)
Sıcak su sıcaklığı: azami 60 °C
Termik dezenteksiyon: azami 70 °C / 4 dak

Kontrol işaretleri (Bakınız sayfa 17)

Yedek Parçalar (Bakınız sayfa 19)



Instrucțiuni de siguranță

- ⚠ Evitați contactul jetului de apă cu părțile de corp sensibile (de ex. ochi). Țineți dușul la o distanță corespunzătoare de corp.

Montare (vezi pag. 19)

Montajî garnitura de filtru livrată împreună cu capătul de duş de mânã pentru evitarea pãtrunderii impurităților din rețeaua de alimentare. Impuritățile pătrunse pot influența funcționarea aparatului și/sau provoca deteriorarea capătului de duş. Garanția nu acoperă aceste daune.

Curățare (vezi pag. 20) și broșura

alăturată

Date tehnice

Presiune de funcționare: max. 0,6 MPa
Presiune de funcționare recomandată: 0,1 - 0,4 MPa
(1 MPa = 10 bar = 147 PSI)
Temperatura apei calde: max. 60 °C
Dezinfecție termică: max. 70 °C / 4 min

Certificat de testare (vezi pag. 17)

Piese de schimb (vezi pag. 19)

**Υποδείξεις ασφαλείας**

- ⚠ Η επαφή δέσμης νερού του ντους με ευαίσθητες περιοχές του σώματος (π.χ. μάτια) πρέπει να αποφευχθεί. Διατηρείτε επαρκή απόσταση ανάμεσα στο ντους και το σώμα.

**Varnostna opozorila**

- ⚠ Izogibati se je treba stiku prhalnega curka z občutljivimi deli telesa (npr. očmi). Med telesom in prho mora biti vedno zadosten razmik.

Συναρμολόγηση (βλ. σελίδα 19)

Πρέπει να εγκατασταθεί το παρίμβυσμα φίλτρου που συνοδεύει τον καταιονιστήρα κατά τέτοιο τρόπο, ώστε να αποφεύγονται ρυτίες που προέρχονται από το δίκτυο ύδρευσης. Οι ρυτίες από το δίκτυο ύδρευσης μπορούν να επηρεάσουν αρνητικά και/ή να προσεγγίσουν ζήμια στα λειπουρικά τμήματα του καταιονιστήρα (ντους). Τέτοιου είδους ζήμιες δεν καλύπτονται από την εγγύηση Hansgrohe.

Καθαρισμός (βλ. σελίδα 20) και συντηγμένο φυλλάδιο

Τεχνικά Χαρακτηριστικά

- Λειτουργία πίεσης: έως 0,6 MPa
Συνιστώμενη λειτουργία πίεσης: 0,1 - 0,4 MPa
(1 MPa = 10 bar = 147 PSI)
Θερμοκρασία ζεστού νερού: έως 60 °C
Θερμική απόλυμανση: έως 70 °C / 4 min

Σήμα ελέγχου (βλ. σελίδα 17)**Ανταλλακτικά** (βλ. σελίδα 19)**Montage** (glejite stran 19)

Filter, ki je priložen ročni prhi, je potrebno vgraditi, da prho zaščitiimo pred umazanijo iz vodovodne napeljavne. Umazanija lahko okvari ali poškoduje dele ročne prhe. Za tako nastalo škodo Hansgrohe ne odgovarja.

Čiščenje (glejite stran 20) in priložena brošura

Tehnični podatki

Delovni tlak: maks. 0,6 MPa
Priporočeni delovni tlak: 0,1 - 0,4 MPa
(1 MPa = 10 bar = 147 PSI)
Temperatura tople vode: maks. 60 °C
Termična dezinfekcija: maks. 70 °C / 4 min

Preskusni znak (glejite stran 17)

Rezervni deli (glejite stran 19)

**Ohutusjuhised**

- ⚠️ Duši veelood ei tohi kokku puutuda tundlike kehaosadega (nt silmad).
Jätke duši ja keha vahele piisav vahe.

**Drošības norādes**

- ⚠️ Nepieciešams izvairīties no dušas strūkļas tieša kontakta ar jutīgām ķermeņa daļām (piem., acīm).
Nepieciešams ievērot pietiekošu attālumu starp dušu un ķermeni.

Paigaldamine (vt lk 19)

Kaismaks duši torust tuleva mustuse eest, on vaja paigaldada dušiga kaasašolev mustusesöl. Sissetulev mustus võib funkcioneerimist kahljustada ja/või rikkuda duši detaile. Sellest tulenevate kahjude eest Hansgrohe ei vastuta.

Puhastamine (vt lk 20) ja

kaasašolev brošüür

Tehnilised andmed

Töörõhk maks. 0,6 MPa
Soovitatav töörõhk: 0,1 - 0,4 MPa
(1 MPa = 10 baari = 147 PSI)
Kuuma vee temperatuur: maks. 60°C
Termiline desinfektsioon:
maks. 70°C / 4 min

Kontrollsertifikaat (vt lk 17)**Varuosad** (vt lk 19)**Montāža** (skat. 19. lpp.)

Jāiemontē dušas komplektā esošais filtrs, lai novērstu neīrīrumu ieplūšanu no ūdens vada. Ieskalotie neīrīrumi var traucēt dušas funkciju un / vai arī izraisīt rokas dušas daļu bojājumus, par kuriem Hansgrohe nenes atbildību.

Trīšana (skat. 20. lpp.) un klāt pievienotais buklets

Tehniskie dati

Darba spiediens: maks. 0,6 MPa
Ieteicamais darba spiediens: 0,1 - 0,4 MPa
(1 MPa = 10 bar = 147 PSI)
Karstā ūdens temperatūra: maks. 60°C
Termiskā dezinfekcija:
maks. 70°C / 4 min

Pārbaudes zīme (skat. 17. lpp.)

Rezerves daļas (skat. 19. lpp.)

**Sigurnosne napomene**

- ⚠ Mora se izbegavati kontakt mlaza iz tuša sa oseljivim delovima tela (npr. očima). Telo korisnika mora biti na dovoljnom odstojanju od tuša.

Montaža (vidi stranu 19)

- Obavezno ugradite mrežicu upakovanu s tušem, čime sprečavate ulazak prljavaštine iz vodovoda. Prljavaština može dovesti do delimičnog ili potpunog oštećenja delova tuša. Za eventualna oštećenja uzrokovana prljavaštinom proizvođač Hansgrohe nije odgovoran.

Čišćenje (vidi stranu 20) i priložena brošura**Tehnički podaci**

- Radni pritisak: maks. 0,6 MPa
Preporučeni radni pritisak: 0,1 - 0,4 MPa
(1 MPa = 10 bar = 147 PSI)
Temperatura vruće vode: maks. 60 °C
Termička dezinfekcija: maks. 70 °C / 4 min
- Ispitni znak** (vidi stranu 17)
- Rezervni delovi** (vidi stranu 19)

**Sikkerhetshenvisninger**

- ⚠ Dusjstrålen skal ikke komme i kontakt med ømfintlige kroppsdeler (f.eks. øynene). Overhold en tilstrekkelig avstand mellom dusjen og kroppen.

Montasje (se side 19)

- Silpakningen som er levert med dusjen skal bygges inn for å forhindre at smuss spyles inn fra ledningsnettet. Innspylt smuss kan påvirke funksjonen negativt og/eller kan medføre skader på hånddusjens funksjonsdeler. Hansgrohe påtar seg inget ansvar for skader som resulteres av dette.

Rengjøring (se side 20) og vedlagt brosjyre**Tekniske data**

- Driftstrykk maks. 0,6 MPa
Anbefalt driftstrykk: 0,1 - 0,4 MPa
(1 MPa = 10 bar = 147 PSI)
Yarmt vannstemperatur maks. 60 °C
Termisk desinfisering: maks. 70 °C / 4 min
- Prøvermerke** (se side 17)
- Servicedeler** (se side 19)



Указания за безопасност

- ⚠️ Трябва да се избягва контакта на струите на разпръсквателя с чувствителни части на тялото (напр. очите). Между разпръсквателя и тялото трябва да се спазва достатъчно разстояние.

Монтаж (вижте стр. 19)

Опакованото заедно с разпръсквателя улпътнение с целка трябва да се монтира, за да се избегне натрупване на замърсявания от водопроводната мрежа. Натрупването на замърсявания може да наруши функцията и/или да доведе до увреждания на функционалните части на разпръсквателя, Hansgrohe не носи отговорност за получилите се по този начин щети.

Почистяване (вижте стр. 20) и приложена брошура

Технически данни

Работно налягане: макс. 0,6 МПа
Препоръчително работно

налягане: 0,1 - 0,4 МПа
(1 МПа = 10 bar = 147 PSI)

Температура на горещата вода: макс. 60°C
Термична дезинфекция: макс. 70°C / 4 мин

Контролен знак (вижте стр. 17)

Сервизни части (вижте стр. 19)



Udhëzime sigurie

- ⚠️ Kontakti i valëve të dushit me pjesët e pafeshme të trupit (p.sh. me sytë) duhet që të shmangët. Midis dushit dhe trupit duhet që të mbahet një distancë e miftueshme.

Montimi (shih faqen 19)

Stifa që i kemi bashkëngjitur sprëkatësës duhet rëndoritur për të evituar fthitjen e paparsëritive nga rritjet i ujësiellësit. Ndojëet mund të demtojnë pjesë funksionale të sprëkatësës. Hansgrohe nuk merr përgjegjësinë për dëmet e shkaktuara në këtë mënyrë.

Pastrimi (shih faqen 20) dhe broshura bashkëngjiftur

Të dhëna teknike

Presioni gjatë punës maks. 0,6 МПа
Presioni i rekomanduar: 0,1 - 0,4 МПа
(1 МПа = 10 bar = 147 PSI)

Температура е ујит të ngrohtë maks. 60°C
Dezinfektim Termik: maks. 70°C / 4 min

Shenja e kontrollit (shih faqen 17)

Pjesë ndërrimi (shih faqen 19)

⚠️ تنبيهات الأمان

⚠️ يجب تجنب حدوث اتصال مباشر بين الماء الخارج من رأس الدش وبين أجزاء الجسم الحساسة (مثل العينين). يجب وجود مسافة كافية بين رأس الدش والجسم.

التركيب (راجع صفحة 19)
يجب إدخال الحلقة الشبكية لحماية الدش اليدوي من الأوساخ التي تحملها شبكة الواسير. حيث تؤدي الأوساخ الواردة إلى حدوث أعطال أو / وقد تتسبب في تلف أجزاء من من الدش. ومثل هذه الأعطال تلغي كافة المطالبات الخاصة بالمسؤولية أو الضمان.
التنظيف (راجع صفحة 20) والكتيب اللفظ

المواصفات الفنية

ضغط التشغيل:

الحد الأقصى 0,6 ميجابسكال

ضغط التشغيل الموصى به:

0,4-0,1 ميجابسكال

1 ميجابسكال = 10 بار = 147 (PSI)

درجة حرارة الماء الساخن:

الحد الأقصى 60°C

تقييم حراري:

الحد الأقصى 70°C / 4 الدقيقة

شهادة اختبار (راجع صفحة 17)

قطع الغيار (راجع صفحة 19)

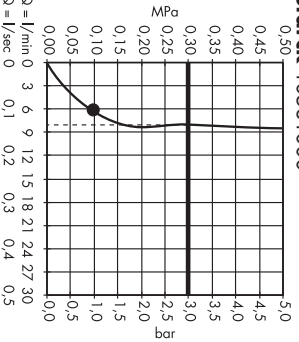
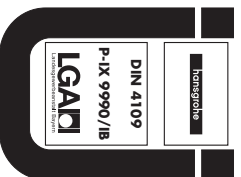
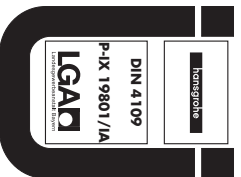
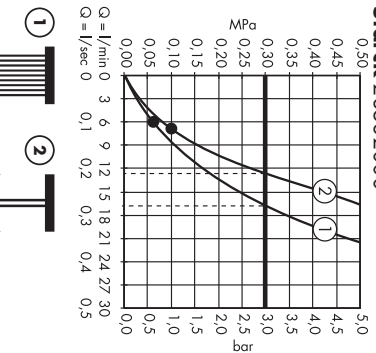
Starck 10531000**Starck 28532000**

	P-IX	DVGW	SVGW	ACS	WRAS	NF	KIWA
10531000	P-IX 19801/IA		X	X	X		X
28532000	P-IX 9990/IB	BR0047	X	X	X		X

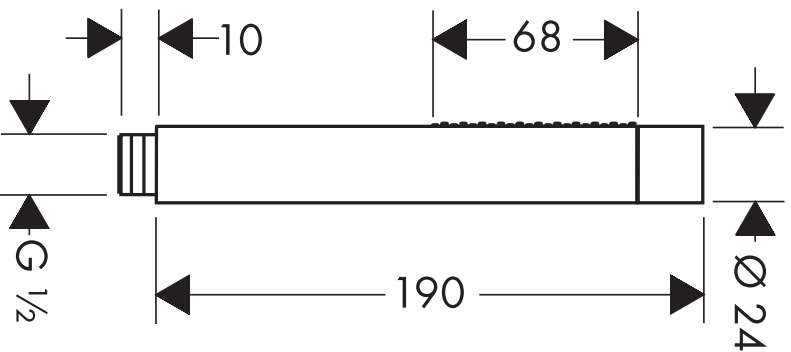
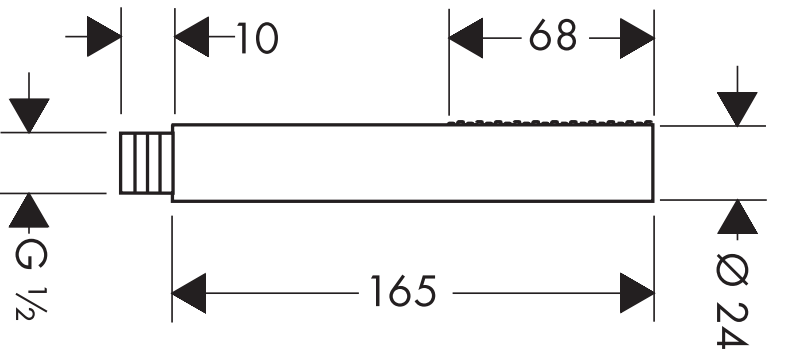

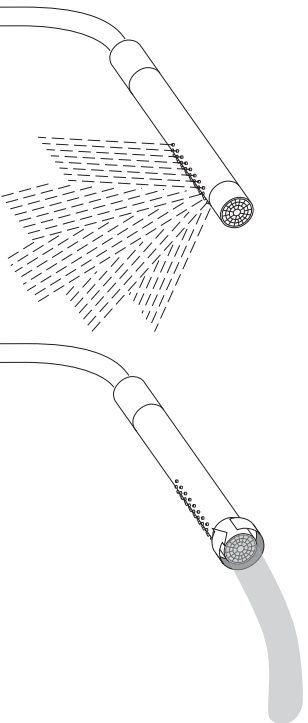
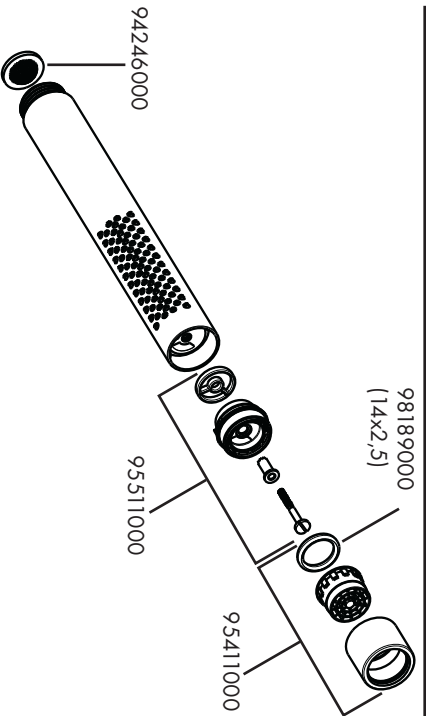
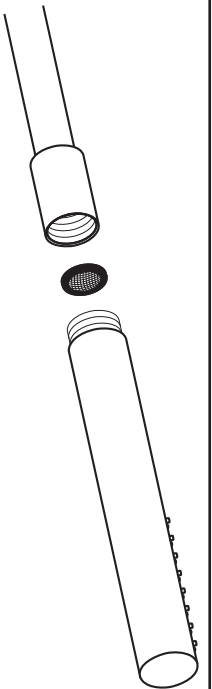

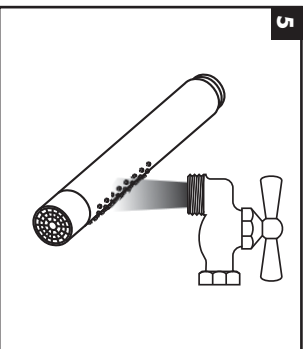
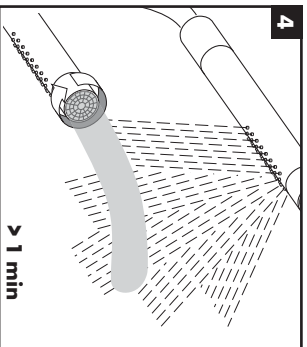
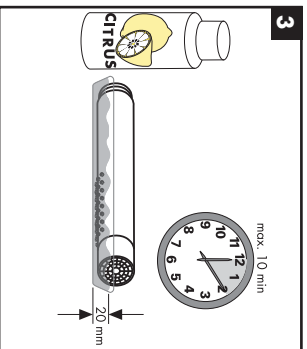
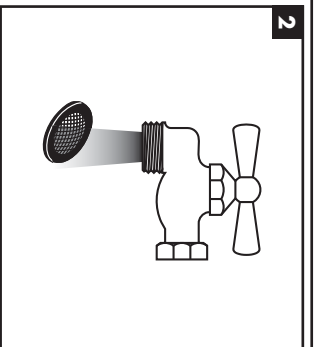
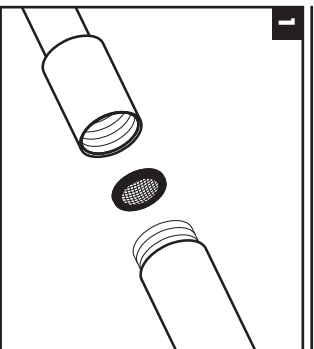







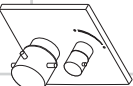
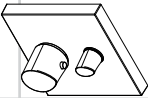

hansgrøhe

02/2015
9.08378.04

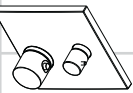
AXXOR®

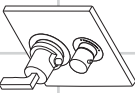
hansgrohe

DE	Gebruiksaanleitung / Montageanleitung	2			
FR	Mode d'emploi / Instructions de montage	4			
EN	Instructions for use / assembly instructions	6			
IT	Istruzioni per l'uso / Istruzioni per l'installazione	8			
ES	Modo de empleo / Instrucciones de montaje	10			
NL	Gebruiksaanwijzing / Handleiding	12			
DK	Brugsanvisning / Monteringsvejledning	14	Starck	Starck X	Starck Organic
PT	Instruções para uso / Manual de instalação	16	10700000	10706000	12715000
PL	Instrukcja obsługi / Instrukcja montażu	18			
CS	Návod k použití / Montážní návod	20			
SK	Návod na použitie / Montážny návod	22			
ZH	用户手册 / 组装说明	24			
RU	Руководство пользователя / Инструкция по монтажу	26	Montreux	Carlton	Carlton
			16800XXX	17700XXX	17705XXX
HU	Használati útmutató / Szerelési útmutató	28			
FI	Käyttöohje / Asemusohje	30			
SV	Bruksanvisning / Monteringsanvisning	32			
LT	Vartotojo instrukcija / Montavimo instrukcijos	34			
HR	Upute za uporabu / Uputstvo za instalaciju	36			
TR	Kullanım kılavuzu / Montaj kılavuzu	38	Massaud	Citerio M	Uno
			18745000	34705000	38700000
RO	Manual de utilizare / Instrucțiuni de montare	40			
EL	Οδηγίες Χρήσης / Οδηγία συναρμολόγησης	42			
SL	Navodilo za uporabo / Navodila za montažo	44			
EI	Kasutusjuhend / Paigaldusjuhend	46			
LV	Lietošanas pamācība / Montāžas instrukcija	48	Citerio	Citerio	Bouroulic
			39700000	39705000	19704000
SR	Uputstvo za upotrebu / Uputstvo za montažu	50			
NO	Bruksanvisning / Montasjeveiledning	52			
BG	Инструкция за употреба / Ръководство за монтаж	54			
SQ	Udhëzuesi i përdorimit / Udhëzime rreth montimit	56			
AR	دليل الاستخدام / تعليمات التجميع	59			



Sicherheitshinweise

- ⚠ Bei der Montage müssen zur Vermeidung von Quetsch- und Schnittverletzungen Handschuhe getragen werden.
 - ⚠ Das Produkt darf nur zu Bade-, Hygiene- und Körperreinigungszwecken eingesetzt werden.
 - ⚠ Kinder, sowie Erwachsene mit körperlichen, geistigen und / oder sensorischen Einschränkungen dürfen das Produkt nicht unbeaufsichtigt benutzen. Personen, die unter Alkohol- oder Drogeneinfluss stehen, dürfen das Produkt nicht benutzen.
 - ⚠ Große Druckunterschiede zwischen den Kalt- und Warmwasseranschlüssen müssen ausgeglichen werden.
- ## Montagehinweise
- Die Armatur muss nach den gültigen Normen montiert, gespült und geprüft werden!
 - Die in den Ländern jeweils gültigen Installationsrichtlinien sind einzuhalten.
 - Vor der Montage muss das Produkt auf Transportschäden untersucht werden. Nach dem Einbau werden keine Transport- oder Oberflächenschäden anerkannt.

Technische Daten

Betriebsdruck:	max. 1 MPa
Empfohlener Betriebsdruck:	0,1 - 0,5 MPa
Prüfdruck: (1 MPa = 10 bar = 147 PSI)	1,6 MPa
Heißwassertemperatur:	max. 80 °C
Empfohlene Heißwassertemperatur:	65 °C
Thermische Desinfektion:	max. 70 °C / 4 min

Eigensicher gegen Rückfließen

Das Produkt ist ausschließlich für Trinkwasser konzipiert!

Symbolerklärung



Kein essigsäurehaltiges Silikon verwenden!

max. $\approx 42^{\circ}\text{C}$ Safety Function (siehe Seite 63)

Dank der Safety Function lässt sich die gewünschte Höchsttemperatur von z. B. max. 42 °C voreinstellen.



Einjustieren (siehe Seite 62)

Nach erfolgter Montage muss die Auslauf-temperatur des Thermostaten überprüft werden. Eine Korrektur ist erforderlich wenn die an der Einbaustelle gemessene Temperatur von der am Thermostaten eingestellten Temperatur abweicht.



Wartung (siehe Seite 66)

- Um die Leichtigängigkeit der Regeleinheit zu gewährleisten, sollte der Thermostat von Zeit zu Zeit auf ganz warm und ganz kalt gestellt werden.
- Der Thermostat ist mit Rückflussverhindern ausgestattet. Rückflussverhinderer müssen gemäß DIN EN 1717 regelmäßig in Übereinstimmung mit nationalen oder regionalen Bestimmungen (DIN 1988 einmal jährlich) auf ihre Funktion geprüft werden.



Serviceteile (siehe Seite 69)

XXX = Farbcodierung
000 = chrom
090 = chrom/gold-optik
820 = brushed nickel

Bedienung (siehe Seite 64)





Maße (siehe Seite 65)



Prüfzeichen (siehe Seite 68)

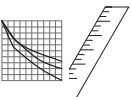

Durchflusssdiagramm

(siehe Seite 68)



Reinigung

siehe beiliegende Broschüre

Störung	Ursache	Abhilfe
Wenig Wasser	<ul style="list-style-type: none">- Versorgungsdruck nicht ausreichend- Schmutzfangsieb der Regelleinheit verschmutzt- Siebdichtung der Brause verschmutzt	<ul style="list-style-type: none">- Leitungsdruck prüfen- Schmutzfangsiebe vor dem Thermostat und auf der Regelleinheit reinigen- Siebdichtung zwischen Brause und Schlauch reinigen
Kreuzfluss, warmes Wasser wird bei geschlossener Armatur in die Kaltwasserleitung gedrückt oder umgekehrt	<ul style="list-style-type: none">- Rückflussverhinderer verschmutzt / defekt	<ul style="list-style-type: none">- Rückflussverhinderer reinigen ggf. austauschen
Auslauftemperatur stimmt nicht mit der eingestellten Temperatur überein	<ul style="list-style-type: none">- Thermostat wurde nicht justiert- Zu niedrige Warmwassertemperatur	<ul style="list-style-type: none">- Thermostat justieren- Warmwassertemperatur erhöhen auf 42 °C bis 65 °C
Temperaturregelung nicht möglich	<ul style="list-style-type: none">- Temperaturregelleinheit verschmutzt oder verkalkt- Bei Neuinstallation Grundkörper falsch angeschlossen (Soll: kalt rechts, warm links) oder 180° verdreht eingebaut	<ul style="list-style-type: none">- Temperaturregelleinheit reinigen ggf. austauschen- Funktionsblock um 180° verdreht einbauen
Druckknopf der Sicherheitsperre ohne Funktion	<ul style="list-style-type: none">- Feder defekt- Druckknopf verkalkt / verschmutzt	<ul style="list-style-type: none">- Feder bzw. Druckknopf reinigen u. leicht fetten, ggf. austauschen
Ventil schwergängig	<ul style="list-style-type: none">- Absperroberteil beschädigt	<ul style="list-style-type: none">- Absperroberteil austauschen
Brause oder Auslauf tropft	<ul style="list-style-type: none">- Schmutz oder Ablagerungen auf dem Dichtsitz, Absperroberteil beschädigt	<ul style="list-style-type: none">- Absperroberteil reinigen bzw. austauschen



Montage siehe Seite 60



⚠️ Consignes de sécurité

- ⚠️ Lors du montage, porter des gants de protection pour éviter toute blessure par écrasement ou coupure.
- ⚠️ Le système de douche ne doit servir qu'à se laver et à assurer l'hygiène corporelle.
- ⚠️ Il est interdit aux enfants ainsi qu'aux adultes ayant des insuffisances physiques, psychiques et/ou motoriques d'utiliser la douche sans surveillance. De même, il est interdit à des personnes sous influence d'alcool ou de drogues d'utiliser la douche.
- ⚠️ Il est conseillé d'équilibrer les pressions de l'eau chaude et froide.

Instructions pour le montage

- La robinetterie doit être installée, rincée et contrôlée conformément aux normes valables!
- Les directives d'installation en vigueur dans le pays concerné doivent être respectées.
- Avant son montage, s'assurer que le produit n'a subi aucun dommage pendant le transport. Après le montage, tout dommage de transport ou de surface ne pourra pas être reconnu.

Informations techniques

Pression de service autorisée:	max. 1 MPa
Pression de service conseillée:	0,1 - 0,5 MPa
Pression maximum de contrôle:	1,6 MPa
(1 MPa = 10 bar = 147 PSI)	
Température d'eau chaude:	max. 80 °C
Température recommandée:	65 °C
Désinfection thermique:	max. 70 °C / 4 min

Avec dispositif anti-retour

Le produit est exclusivement conçu pour de l'eau potable!

Description du symbole



Ne pas utiliser de silicone contenant de l'acide acétique!

max. $\approx 42^{\circ}\text{C}$ Safety Function (voir pages 63)

Grâce à la fonction Safety, il est possible de régler la température maximale par exemple max. 42 °C souhaitée.



Réglage (voir pages 62)

Le montage terminé, contrôler la température de l'eau puisée au mitigeur thermostatique. Un étalonnage est nécessaire si la température de l'eau mitigée mesurée au point de puisage diffère sensiblement de celle affichée sur le thermostat.



Entretien (voir pages 64)

- Pour assurer le mouvement facile de l'élément thermostatique, le thermostat devrait être placé de temps en temps en position très chaude et très froide.
- Le mitigeur thermostatique est équipé de clapets anti-retour. Les clapets anti-retour doivent être examinés régulièrement conformément à la norme EN 1717 ou conformément aux dispositions nationales ou régionales quant à leur fonction (au moins une fois par an).



Pièces détachées (voir pages 69)

XXX = Couleurs
000 = chromé
090 = chromé/or l'optique
820 = brushed nickel



Instructions de service (voir pages 64)



Dimensions (voir pages 65)



Classification acoustique et débit (voir pages 68)

Diagramme du débit



Nettoyage

(voir pages 68)

voir la brochure ci-jointe

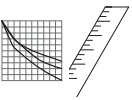

Dysfonctionnement

Origine

Solution

Pas assez d' eau

- Pression d' alimentation insuffisante
- Filtre de l' élément thermostatique encrassé

- Contrôler la pression
- Nettoyer les filtres devant le mitigeur thermostatique et sur la cartouche

- Joint-filtre de douche encrassé

- Nettoyer le joint-filtre entre la douche et le flexible

Circulation opposée, l' eau chaude est comprimée dans l' arrivée d' eau froide et vice versa avec robinet fermé

- Clapet anti-retour encrassé ou défectueux

- Nettoyer le clapet anti-retour ou le changer éventuellement

La température à la sortie ne correspond pas à la température de réglage

- Le thermostat n' a pas été réglé
- Température d'eau chaude trop basse, pas d' eau froide

- Régler le thermostat
- Augmenter la température d' eau chaude entre 42°C et 65°C

Le réglage de la température n' est pas possible

- L' élément thermostatique est encrassé ou entartré
- Nettoyer l' élément thermostatique ou le changer éventuellement
- La pièce de base a une alimentation inversée (l' eau froide doit être à droite et l' eau chaude à gauche) ou elle est montée à l' envers
- Montez le bloc de fonction à 180°

Bouton à pression du verrouillage de sécurité défectueux

- Ressort défectueux
- Bouton/poussoir entartré / encrassé

- Nettoyer le ressort ou bien le bouton à pression, le changer éventuellement

Fonctionnement de la poignée difficile

- Mécanisme d' arrêt défectueux

- Changez le mécanisme d' arrêt

La douille ou le bec verseur goutte

- De la saleté ou de l' incrustation sur le siège, mécanisme d' arrêt défectueux
- Nettoyez le mécanisme d' arrêt ou le changez éventuellement



Montage voir pages 60



Safety Notes

- ⚠️ Gloves should be worn during installation to prevent crushing and cutting injuries.
 - ⚠️ The shower system may only be used for bathing, hygienic and body cleansing purposes.
 - ⚠️ Children as well as adults with physical, mental and/or sensoric impairments must not use this shower system without proper supervision. Persons under the influence of alcohol or drugs are prohibited from using this shower system.
 - ⚠️ The hot and cold supplies must be of equal pressures.
- ### Installation Instructions
- The fitting must be installed, flushed and tested after the valid norm!
 - The plumbing codes applicable in the respective countries must be observed.
 - Prior to installation, inspect the product for transport damages. After it has been installed, no transport or surface damage will be honoured.

Technical Data

- Operating pressure: max. 1 MPa
Recommended operating pressure: 0,1 - 0,5 MPa
Test pressure: 1,6 MPa
(1 MPa = 10 bar = 147 PSI)
- Hot water temperature: max. 80 °C
Recommended hot water temp.: 65 °C
Thermal disinfection: max. 70 °C / 4 min
- Safety against backflow
- The product is exclusively designed for drinking water!

Symbol description



Do not use silicone containing acetic acid!

max. $\approx 42^{\circ}\text{C}$ Safety Function (see page 63)

The desired maximum temperature for example max. 42° C can be pre-set thanks to the safety function.



Adjustment (see page 62)

After the installation, the output temperature of the thermostat must be checked. A correction is necessary if the temperature measured at the output differs from the temperature set on the thermostat.



Maintenance (see page 66)

- To guarantee the smooth running of the thermostat, it is necessary from time to time to turn the thermostat from total hot to total cold.
- The mixer is equipped with check valves. The check valves must be checked regularly according to DIN EN 1717 in accordance with national or regional regulations (at least once a year).



Spare parts (see page 69)

- XXX = Colors
000 = chrome plated
090 = chrome plated/gold plated
820 = brushed nickel

Operation (see page 64)





Dimensions (see page 65)



Test certificate (see page 68)

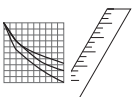

Flow diagram

(see page 68)



Cleaning

see enclosed brochure

Fault	Cause	Remedy
Insufficient water	- Supply pressure inadequate	- Check water pressure (If a pump has been installed check to see if the pump is working).
Crossflow, hot water being forced into cold water pipe, or vice versa, when mixer is closed	- Backflow preventers dirty or leaking	- Clean filter in front of the mixer and on the MTC-thermo cartridge
Spout temperature does not correspond with temperature set	- Thermostat has not been adjusted	- Clean filter seal between shower and hose
Temperature regulation not possible	- Hot water temperature too low	- Clean backflow preventers, exchange if necessary
	- Temperature regulator dirty or calcified	- Adjust thermostat
	- Temperature regulator dirty or calcified	- Increase hot water temperature to 42 °C to 65 °C
	- For new installations: basic body incorrectly connected (should be: cold right, hot left) or installed with 180° rotation	- Clean temperature regulator, exchange if necessary
	- Spring defective	- Install function block turned through 180°
Safety stop button not operating	- push button calcified / contaminated	- Clean spring and/or button, exchange if necessary
Valve stiff	- Shut-off unit damaged	- Exchange shut-off unit
Shower or spout dripping	- Dirt or sedimentation on valve seat, shut-off unit damaged	- Clean or exchange shut-off unit

Special information for UK (see page 73)



Assembly see page 60



Indicazioni sulla sicurezza

- Durante il montaggio, per evitare ferite da schiacciamento e da taglio bisogna indossare guanti protettivi.
- Il sistema doccia deve essere utilizzato esclusivamente per l'igiene del corpo.
- I bambini e gli adulti affetti da menomazioni fisiche, psichiche e/o sensoriali devono utilizzare il sistema doccia solo sotto sorveglianza. Il prodotto non deve essere utilizzato da persone sotto l'effetto di droghe o alcolici.
- **Attenzione!** Compensare le differenze di pressione tra i collegamenti dell'acqua fredda e dell'acqua calda.

Istruzioni per il montaggio

- La rubinetteria deve essere installata, pulita e testata secondo le istruzioni riportate!
- Vanno rispettate le direttive di installazione nazionali vigenti nel rispettivo paese.
- Prima del montaggio è necessario controllare che non ci siano stati danni durante il trasporto. Una volta eseguito il montaggio, non verranno riconosciuti eventuali danni di trasporto o delle superfici.

Dati tecnici

- Pressione d'uso: max. 1 MPa
- Pressione d'uso consigliata: 0,1 - 0,5 MPa
- Pressione di prova: 1,6 MPa
(1 MPa = 10 bar = 147 PSI)
- Temperatura dell'acqua calda: max. 80 °C
- Temp. dell'acqua calda consigliata: 65 °C
- Disinfezione termica: max. 70 °C / 4 min
- Sicurezza antiriflusso
- Il prodotto è concepito esclusivamente per acqua potabile!

Descrizione simbolo



Non utilizzare silicone contenente acido acetico!

max. ≈ 42 °C
Safety Function (vedi pagg. 63)

Grazie alla funzione antiscontatture Safety la temperatura massima per esempio max. 42 °C desiderata è facilmente regolabile.



Taratura (vedi pagg. 62)

Effettuata l'installazione del miscelatore termostatico bisogna controllare la temperatura di uscita. La taratura è necessaria quando la temperatura dell'acqua misurata sul punto di prelievo non corrisponde a quella fissata sul termostato.



Manutenzione (vedi pagg. 66)

- Per garantire la scorrevolezza dell'elemento di regolazione, di tanto in tanto si dovrebbe regolare il termostatico passando da tutto caldo a tutto freddo.
- Il miscelatore termostatico è dotato di una valvola antiriflusso. La valvola di non ritorno deve essere controllata regolarmente come da DIN EN 1717, secondo le normative nazionali e regionali (almeno una volta all'anno).



Parti di ricambio (vedi pagg. 69)

- XXX = Trattamento
- 000 = cromato
- 090 = cromo/dorato ottico
- 820 = brushed nickel



Procedura (vedi pagg. 64)



Ingombri (vedi pagg. 65)



Segno di verifica (vedi pagg. 68)



Diagramma flusso

(vedi pagg. 68)

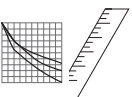

Pulitura

vedi il prospetto accluso

Problema	Possibile causa	Rimedio
Scaricit� di acqua	- Pressione di erogazione insufficiente	- Prelevare la pressione di erogazione
	- Filtro dell'unit� di regolazione sporco	- Pulire/sostituire i filtri
	- Guarnizione del filtro della doccia sporca	- Pulire la guarnizione del filtro tra doccia e flessibile
Flusso incrociato: l'acqua calda viene spinta nella tubatura acqua fredda a rubinetteria chiusa o viceversa	- Antiriflusso sporco o non ermetico	- Pulire o sostituire l'antiriflusso
La temperatura di erogazione diversa da quella impostata	- Il termostatico non � stato regolato	- Regolare il termostatico
	- Temperatura dell'acqua calda	- Aumentare la temperatura acqua calda tra 42 �C e 65 �C
Impossibile la regolazione temperatura	- Elemento termostatico sporco o con depositi calcarei	- Pulire o sostituire l'unit� di regolazione
	- In caso di nuova installazione - collagato male il termostatico (deve essere: acqua fredda a destra e calda a sinistra) o installato ruotato di 180�	- Ruotare di 180� l'unit� di regolazione
Tasto antiscottatura non funzionante	- Molla difettosa	- Pulire o sostituire la molla o il tasto
	- Pulsante pieno di calcare / intasato	
Rubinello duro	- vitone di arresto danneggiato	- sostituire il vitone di arresto
Doccia / scarico gocciola	- Sporco o depositi nella sede della guarnizione, vitone di arresto danneggiato	- Pulire o sostituire il vitone di arresto



Montaggio vedi pagg. 60



Indicaciones de seguridad

- ⚠ Durante el montaje deben utilizarse guantes para evitar heridas por aplastamiento o corte.
 - ⚠ La grifería solo debe ser utilizada para fines de baño, higiene y limpieza corporal.
 - ⚠ Niños, así como adultos con limitaciones corporales, mentales y/o sensoriales no deben utilizar el sistema de duchas sin vigilancia. Personas que se encuentran bajo el efecto de alcohol o drogas, no deben utilizar el sistema de duchas.
 - ⚠ Grandes diferencias de presión en servicio entre agua fría y agua caliente deben equilibrarse.
- ### Indicaciones para el montaje
- El grifo tiene que ser instalado, probado y testado, según las normas en vigor.
 - Es obligatorio el cumplimiento de las directrices de instalación vigentes en el país respectivo.
 - Antes del montaje se debe examinar el producto contra daños de transporte. Después de la instalación so se reconoce ningún daño de transporte o de superficie.

Datos técnicos

- Presión en servicio: max. 1 MPa
Presión recomendada en servicio: 0,1 - 0,5 MPa
Presión de prueba: 1,6 MPa
(1 MPa = 10 bar = 147 PSI)
Temperatura del agua caliente: max. 80 °C
Temp. recomendada del agua caliente: 65 °C
Desinfección térmica: max. 70 °C / 4 min
- Seguro contra el retorno
- El producto ha sido concebido exclusivamente para agua potable.

Descripción de símbolos



No utilizar silicona que contiene ácido acético!

max. ≈ 42 °C

Safety Function (ver página 63)

Gracias al tope de temperatura se puede graduar la temperatura máxima por ejemplo max. 42 °C.



Puesta a punto (ver página 62)

Después del montaje deberá comprobarse la temperatura del agua del termostato, en la salida del caño. Una corrección se efectuará siempre y cuando la temperatura del agua tomada a la salida del caño, no corresponda con la indicada en el volante del termostato.



Mantenimiento (ver página 66)

- Para garantizar el funcionamiento duradero del termostato, el mando del mismo debería girarse de vez en cuando del extremo frío al extremo caliente.
- El termostato está equipado con válvula, la cual evita el retorno del agua a la tubería. Las válvulas anti-retorno tienen que ser controladas regularmente según la norma DIN EN 1717, en acuerdo con las regulaciones nacionales o regionales (una vez al año, por lo menos).



Repuestos (ver página 69)

- XXX = Acabados
- 000 = cromado
- 090 = cromo/oro óptica
- 820 = brushed nickel

Manejo (ver página 64)





Dimensiones (ver página 65)



Marca de verificación (ver página 68)



Diagrama de circulación

(ver página 68)



Limpia

ver el folleto adjunto

Problema	Causa	Solución
Sale poca agua	<ul style="list-style-type: none">- presión insuficiente- filtro del termoelemento sucio	<ul style="list-style-type: none">- comprobar presión- limpiar filtros en las uniones a las tomas de agua caliente y fría y en el cartucho termostático
Flujo de agua cruzada agua caliente entra en la tubería del agua fría o al revés	<ul style="list-style-type: none">- válvula antirretorno sucia o pierda	<ul style="list-style-type: none">- limpiar / cambiar válvula y teleducha
Temperatura del agua no corresponde a lo marcado	<ul style="list-style-type: none">- termostato no ha sido ajustado- Temperatura del agua caliente demasiado baja	<ul style="list-style-type: none">- ajustar termostato- aumentar temperatura del agua caliente a 42° - 65° C.
No es posible regular la temperatura	<ul style="list-style-type: none">- termoelemento sucio/lleeno de cal- cuerpo empotrado mal montado (debe estar: frío = derecha) o instalado girado en 180°	<ul style="list-style-type: none">- limpiar / cambiar termoelemento- girar embellecedor en 180°
Botón de tope no funciona	<ul style="list-style-type: none">- muelle defecto- Pulsador con restos de cal / sucio	<ul style="list-style-type: none">- limpiar y aplicar una fina capa de grasa en el muelle y el pulsador
Llave de paso va duro	<ul style="list-style-type: none">- montura dañada	<ul style="list-style-type: none">- cambiar montura
Pierde permanentemente agua por el caño	<ul style="list-style-type: none">- Suciedad / Sedimentaciones en el asiento de la llave, o llave dañada	<ul style="list-style-type: none">- limpiar/Cambiar llave de paso



Montaje ver página 60



Veiligheidsinstructies

- ⚠ Bij de montage moeten ter voorkoming van knel- en slijtwoorden handschoenen worden gedragen.
- ⚠ Het douchesysteem mag alleen voor het wassen, hygiënische doeleinden en voor de lichaamsreiniging worden gebruikt.
- ⚠ Kinderen en volwassenen met lichamelijke, geestelijke en/of sensorische beperkingen mogen het douchesysteem niet zonder toezicht gebruiken. Personen onder invloed van alcohol of drugs mogen het douchesysteem niet gebruiken.
- ⚠ Grote drukverschillen tussen de koud- en warmwater-toevoer dienen vermeden te worden.

Montage-instructies

- Leidingen doorspoelen volgens Norm. De mengkraan vervolgens monteren en controleren!
- De in de overeenkomstige landen geldende installatierichtlijnen moeten nageleefd worden.

• **Vóór de montage moet het product gecontroleerd worden op transportschade.** Na de inbouw wordt geen transport- of oppervlakteschade meer aanvaard.

Technische gegevens

Werkdruk: max.	max. 1 MPa
Aanbevolen werkdruk:	0,1 - 0,5 MPa
Geest bij:	1,6 MPa
(1 MPa = 10 bar = 147 PSI)	
Temperatuur warm water:	max. 80 °C
Aanbevolen warm water temp.:	65 °C
Thermische desinfectie:	max. 70 °C / 4 min
Beveiligd tegen terugstromen	

Het product is uitsluitend ontworpen voor drinkwater!

Symboolbeschrijving



Gebruik geen zuurhoudende silicone!

max. ≈ 42 °C
Safety Function (zie blz. 63)

Dankzij de Safety Function kan de gewenste maximale temperatuur van bijv. max. 42° C van te voren worden ingesteld.



Correctie (zie blz. 62)

Na montage dient de uitsroomtemperatuur van de thermostaat gecontroleerd te worden. Een correctie is noodzakelijk als de aan het tappunt gemeten temperatuur afwijkt van de op de thermostaat ingestelde temperatuur.



Onderhoud (zie blz. 66)

- Om het soepel lopen van de regelaarheid te garanderen moet de thermostaat van tijd tot tijd op heel koud en heel warm worden ingesteld.
- De thermostaat is voorzien van terugslagkleppen. Keerleppen moeten volgens DIN EN 1717 regelmatig en volgens plaatselijk geldende eisen op het functioneren gecontroleerd worden. (Tenminste een keer per jaar).



Service onderdelen (zie blz. 69)

XXX = Kleuren
000 = verchroomd
090 = chroom/vergulde look
820 = brushed nickel



Bediening (zie blz. 64)



Maten (zie blz. 65)



Keurmerk (zie blz. 68)



Reinigen

zie bijgevoegde brochure

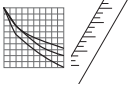

Doorstroomdiagram

(zie blz. 68)

Storing

Orzaak

Oplossing

Weinig water

- Druk te laag
- Druk controleren
- Vuilzaam thermoelement verstopt
- Vuilvangzeefjes en zeefjes van
regeleenheid reinigen

Kruisstroom, warm water stroomt
in gesloten toestand in koud water
leiding of omgekeerd

- Zeefdichting handdouche verstopt
- Zeefdichting handdouche reinigen
- Terrugslagkleppen vervuld of defect
- Terrugslagkleppen reinigen dan
wel uitwisselen

Uitroomtemperatuur komt niet met
ingestelde temperatuur overeen

- Thermostaat niet ingesteld
- Thermostaat installeren
- Temperatuur van warm water te laag
- Warmwater toevoer verhogen min.
42°C naar 65°C

Temperatuur niet regelbaar

- Thermo-element vervuld of verkalkt
- Thermo-element reinigen dan wel
uitwisselen
- Bij nieuwe installaties: basisgarni-
tuur verkeerd aangesloten (moet zijn
koud rechts en warm links) of 180°
gedraaid gemonteerd
- Functieblok 180° draaien

Safety-Stop knop op thermostaat

greep functioneert niet

- Veer defect
- Veer en/of drukknop reinigen dan
wel uitwisselen
- Drukknop verkalkt / verontreinigd
- wel uitwisselen

Kraan draait zwaar

- bovendeeel beschadigd
- Bovendeeel uitwisselen

Douche/uitloop lekt

- Vuil of verkalking op de zitting, boven-
deel beschadigd
- Bovendeeel reinigen of omstelling
uitwisselen



Montage zie blz. 60



Sikkerhedsanvisninger

- ▶ Ved monteringen skal der bruges handsker for at undgå kvæstelser og srtisår.
- ▶ Brusersystemet må kun bruges til bade-, hygiejne og rengøringsformål.
- ▶ Børn som også vokse med fysiske, mentale og / eller sensoriske begrænsninger må ikke bruge brusersystemet uden opsyn. Personer som er under indflydelse af alkohol eller narkotika må ikke bruge brusersystemet.
- ▶ Større trykforfælle mellem koldt og varmt vand bør udlægnes.

Monteringsanvisninger

- Ifølg gældende regler, skal armaturet monteres, skyl-les igennem og afprøves.
- Installationsbestemmelse, der gælder i det enkelte land, skal overholdes.
- Før monteringen skal produktet kontrolleres for transportskader. Efter monteringen godkendes transportska-der eller skader på overfladen ikke længere.

Tekniske data

Driftstryk:	max. 1 MPa
Anbefalet driftstryk:	0,1 - 0,5 MPa
Prøvetryk:	1,6 MPa
(1 MPa = 10 bar = 147 PSI)	
Varmtvandstemperatur:	max. 80 °C
Anbefalet varmtvandstemperatur:	65 °C
Termisk desinfektion:	max. 70 °C / 4 min

Med indbygget kontraventil

Produktet er udelukkende beregnet til drikkevand!

Symbolbeskrivelse



Der må ikke benyttes eddikesyreholdig silikone!

max. ≈ 42 °C Safety Function (se s. 63)

Takket være Safety varmtvands-begrænsningen kan maksimaltemperaturen forudindstilles eksempel max. 42° C.



Justering (se s. 62)

Efter monteringen skal termostatsens udløbs-temperatur kontrolleres. Såfremt den målte vandtemperatur afviger fra den på termostaten viste forindstilling er en korrigerig af skalagrebret nødvendig.



Service (se s. 66)

- For at sikre optimal funktion af termostaten, bør termostaten fra tid til anden motioneres (stilles skiftevis helt varm og helt kold).
- Termostaten er forsynet med kontraventil . Ifølge DIN EN 1717 skal gennemstrømningsbegrænsere i overenstemmelse med nationde regler afprøves regelmæssigt (mindst en gang om året).



Reserve dele (se s. 69)

XXX = Overflade
000 = Krom
090 = Krom/guld optic
820 = Brushed nickel



Brugsanvisning (se s. 64)



Målene (se s. 65)



Godkendelse (se s. 68)

Gennemstrømningsdiagram



Rengøring

(se s. 68)

se venligst den vedlagte brochure

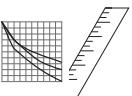

Fejl

Årsag

Hiælp

For lidt vand

- Forsyningstrykket er ikke højt nok
- Smudsfangstien er snovset

- Afprøv forsyningstrykket
- Rengør smudsfangstien foran termostaten og på termostatelementet

- Sien mellem bruser og slange er snovset

- Rengør sien mellem bruser og slange

Kryds-flow, varmt vand i koldtvandsledningen og omvendt

- Kontraventilen er snovset eller utæt.

- Rengør kontraventilen eller udskift den evt.

Udløbstemperaturen stemmer ikke overens med den indstillede temperatur

- Termostaten er ikke justeret
- For lav varmtvandsstemperatur

- Juster termostaten
- Forhøj varmtvandsstemperaturen fra 42°C til 65°C

Temperaturregulering ikke mulig

- Termostatelementet er snovset eller tilkalket

- Rengør termostatelementet eller udskift det evt.

- Ved ny-installation er vandtilslutningen forbyttet (skal være koldt til højre)
- varmt til venstre eller også er grundkroppen drejet 180°)

- Vend indbygningssdelen 180°

Sikkerhedsspærren er ude af funktion

- Defekt fjeder
- trykknop tilkalket / snovset

- Rengør fjeder og trykknop eller udskift delene

Ventilen går trægt

- Beskadiget afspæringsventil

- Udskift afspæringsventilen

Bruser/kartud drypper

- Snovs eller kalk på pakningen, beskadiget afspæringsventil
- Rengør afspæringsventil eller udskift evt.



Montering se s. 60



Avisos de segurança

- ▶ Durante a montagem devem ser utilizadas luvas de protecção, de modo a evitar ferimentos resultantes de entalamentos e de cortes.
- ▶ O sistema de duche só pode ser utilizado para fins de higiene pessoal.
- ▶ Crianças e adultos com deficiências motoras, mentais e/ou sensoriais não podem utilizar o sistema de duche sem monitorização. Pessoas que estejam sob a influência de álcool ou drogas não podem utilizar o sistema de duche.
- ▶ Grandes diferenças entre as pressões das águas quente e fria devem ser compensadas.

Avisos de montagem

- A misturadora deve ser instalada, purgada e testada de acordo com as normas em vigor!
- A prescrições de instalação válidas nos respetivos países devem ser respeitadas.

- Antes da montagem deve-se controlar o produto relativamente a danos de transporte. Após a montagem não são aceites quaisquer danos de transporte ou de superfície.

Dados Técnicos

Pressão de funcionamento:	max. 1 MPa
Pressão de func. recomendada:	0,1 - 0,5 MPa
Pressão testada:	1,6 MPa
(1 MPa = 10 bar = 147 PSI)	
Temperatura da água quente:	max. 80 °C
Temp. água quente recomendada:	65 °C
Desinfeção térmica:	max. 70 °C / 4 min

Função anti-retorno e anti-vácuo

Este produto foi única e exclusivamente concebido para água potável!

Descrição do símbolo



Não utilizar silicone que contenha ácido acético!

max. ≈ 42 °C
Safety Function (ver página 63)

Graças à função de segurança pode-se regular a temperatura máxima por exemplo max. 42°C.



Afinação (ver página 62)

É necessária correcção se a temperatura medida no ponto de saída diferir da temperatura marcada na escala.



Manutenção (ver página 66)

- Para garantir um funcionamento suave do elemento termostático é necessário de vez em quando rodar totalmente o manípulo da termostática da posição quente para a fria.
- A misturadora está equipada com válvulas anti-retorno. As válvulas anti-retorno devem ser verificadas regularmente de acordo com a DIN EN 1717 seguindo os regulamentos nacionais ou regionais (pelo menos uma vez por ano).



Pecas de substituição (ver página 69)

XXX = Acabamentos
000 = cromado
090 = cromado/ouro ótica
820 = brushed nickel

Funcionamento (ver página 64)





Medidas (ver página 65)



Marca de controlo (ver página 68)



Limpeza

consultar a seguinte brochura



Fluxograma
(ver página 68)

Falha	Causa	Solução
Água insuficiente	<ul style="list-style-type: none"> - Pressão não adequada - Filtro do regulador sujo 	<ul style="list-style-type: none"> - Verificar a pressão da água - Limpar o filtro entre o chuveiro e o tubo flexível
Fluxos cruzados, água quente a ser forçada a entrar no tubo da água fria, ou vice-versa, quando a mistura-dora está fechada.	<ul style="list-style-type: none"> - Filtro do vedante do chuveiro sujo 	<ul style="list-style-type: none"> - Limpar o filtro entre o chuveiro e o tubo flexível
Fluxos cruzados, água quente a ser forçada a entrar no tubo da água fria, ou vice-versa, quando a mistura-dora está fechada.	<ul style="list-style-type: none"> - Válvula antirretorno suja ou com fugas 	<ul style="list-style-type: none"> - Limpar a válvula antirretorno, substitua se necessário
A temperatura da água não correponde à temperatura selecionada	<ul style="list-style-type: none"> - A misturadora temos táctica não foi ajustada - Temperatura da água quente muito baixa 	<ul style="list-style-type: none"> - Ajustar a misturadora termostática - Aumentar a temperatura da água quente para 42° C a 65° C.
Não é possível regular a temperatura	<ul style="list-style-type: none"> - Regulador da temperatura sujo ou calcificado - Para novas instalações: Corpo instaladoincorrectamente (deve ser: fria direita, quente esquerda) ou instalado com uma rotação de 180° 	<ul style="list-style-type: none"> - Limpar o regulador de temperatura, substitua se necessário - Instalar o corpo virado 180°
Botão de segurança não funciona	<ul style="list-style-type: none"> - Mola defeituosa - Botão de pressão calcificado / sujo 	<ul style="list-style-type: none"> - Limpar a mola e/ou o botão, substitua se necessário
Válvula de corte perra	<ul style="list-style-type: none"> - Unidade de corte danificada. 	<ul style="list-style-type: none"> - Substituir unidade de corte
Duche/bica a pingar	<ul style="list-style-type: none"> - Sujidade ou sedimentação no assento da válvula 	<ul style="list-style-type: none"> - Limpar ou substituir a unidade de corte



Montagem ver página 60



Wskazówki bezpieczeństwa

- ▲ Aby uniknąć zranień, takich jak zgniecenia czy przecięcia, podczas montażu należy nosić rękawice.
- ▲ Prysznic może być używany tylko do kąpieli, higieny i czyszczenia ciała.
- ▲ Zarówno dzieci, jak i dorośli z fizycznymi, psychicznymi i/lub sensorycznymi ograniczeniami nie mogą korzystać z prysznica bez opieki. Osoby znajdujące się pod wpływem alkoholu lub narkotyków nie mogą korzystać z prysznica.
- ▲ Znaczne różnice ciśnień na dopływach ciepłej i zimnej wody muszą zostać wyrównane.

Wskazówki montażowe

- Armatura musi być zamontowana, przepłukana i wypróbowana według obowiązujących norm!
- Należy przestrzegać wytycznych instalacyjnych obowiązujących w danym kraju.
- Przed montażem należy skontrolować produkt pod kątem szkód transportowych. Po montażu nie widać żadnych szkód transportowych ani szkód na powierzchni.

Dane techniczne

Cisnienie robocze:	maks. 1 MPa
Zalecane ciśnienie robocze:	0,1 - 0,5 MPa
Cisnienie próbnе:	1,6 MPa
(1 MPa = 10 bary = 147 PSI)	
Temperatura wody gorącej:	maks. 80 °C
Zalecana temperatura wody gorącej:	65 °C
Dezynfekcja termiczna:	maks. 70 °C / 4 min

Samoistnie zabezpieczony przed przepływem zwrótnym
Produkt stworzono wyłączanie do wody pitnej!

Opis symbolu



Nie stosować silikonów zawierających kwas octowy!

max. ≈ 42 °C Safety Function (patrz strona 63)

Dzięki funkcji zabezpieczającej można przestawić żądaną maksymalną temperaturę np. na maks. 42°C.



Regulacja (patrz strona 62)

Po ukończeniu montażu należy sprawdzić temperaturę ciepłej wody na wylocie z termostatu. Korekta będzie konieczna wtedy, gdy zmierzona temperatura na wylocie różni się od temperatury ustawionej na termostacie.



Konserwacja (patrz strona 66)

- Aby zachować łatwość obsługi termostatu, od czasu do czasu należy go przetrzeć na czystym zimną i na czystym ciepłą wodę.
- Termostat wyposażony został w zabezpieczenie przed przepływem zwrótnym. Działanie zabezpieczeń przed przepływem zwrótnym, zgodnie z normą DIN EN 1717 i miejscowymi przepisami, musi być kontrolowane (DIN 1988, raz w roku).



Części serwisowe (patrz strona 69)

XXX = Kody kolorów
000 = chrom
090 = chrom/złoty szlachetna
820 = nikiel szorowany

Obsługa (patrz strona 64)





Wymiary (patrz strona 65)



Znak jakości (patrz strona 68)

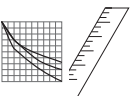

Schemat przepływu

(patrz strona 68)



Czyszczenie

patrz dołączona broszura

Usterka

Mala ilość wody

Przyczyna

- Zbyt niskie ciśnienie zasilałace
- Zabrudzone silko przy wkładzie termostatycznym
- Zabrudzona uszczelka z siłkiem w przysznicu

Pomoc

- Sprawdzić ciśnienie w instalacji
- Wyczyścić silko przed termostatem i we wkładzie termostatycznym
- Oczyszczyć uszczelkę z siłkiem pomiędzy przysznicem a wężem
- Wyczyścić wzgl. wymienić zabezpieczenie przed przepływem zwrótnym

Przepływ krzyżowy, woda ciepła przy zamkniętej armaturze wpływa do przewodu wody zimnej lub odwrotnie

Temperatura wody nie zgadza się z ustaloną wartością

- Termostat nie został wyregulowany
- Za niska temperatura ciepłej wody

- Przeprowadzić regulację termostatu
- Podwyższyć temperaturę wody ciepłej na 42°C do 65°C

Brak możliwości regulacji temperatury

- Zabrudzony lub zakamieniony termostat
- Przy nowej instalacji niewłaściwie podłączony korpus (powinno być: zimna po prawej, ciepła po lewej) albo zamontowano z przekręceniem o 180°.

- Blok funkcyjny obrócić o 180°
- Wyczyścić lub wymienić termostat

Złe funkcjonowanie przycisku zabezpieczającego

- Uszkodzona sprężynka
- Przycisk pokryty kamieniem / zanieczyszczony

- Wyczyścić wzgl. wymienić sprężynkę lub przycisk i lekko nasmarować

Zawór pracuje z wysiłkiem

- Uszkodzony górny element zamkowy

- Wymienić górny element zamkowy

Wyciekająca woda z główki przysnicy lub wylewki

- Brud lub osady na gnieździe uszczelniającym, uszkodzenie górnego elementu zamykającego

- Oczyszczyć ewent. wymienić górny element zamykający



Montaż patrz strona 60



Bezpečnostní pokyny

- ▶ Pro zabránění řezným zraněním a pohmožděním je nutné při montáži nosit rukavice.
- ▶ Produkt smí být používán pouze ke koupání a za účelem tělesné hygieny.
- ▶ Děti a dospělé osoby s tělesným, duševním a / nebo smyslovým postižením nesmí produkt používat bez dozoru. Osoby pod vlivem alkoholu nebo drog nesmí produkt používat.
- ▶ Je nutné vyrovnat velké rozdíly tlaku mezi připoji studené a teplé vody.

Pokyny k montáži

- Armatura se musí montovat, proplachovat a testovat podle platných norem!
- Je třeba dodržovat montážní pravidla platné v dané zemi:
- Před montáží je třeba produkt zkontrolovat, zda nebyl při transportu poškozen. Po zabudování nebudou uznány žádné škody způsobené transportem nebo poškození povrchu.

Technické údaje

Provozní tlak:	max. 1 MPa
Doporučený provozní tlak:	0,1 - 0,5 MPa
Zkušební tlak:	1,6 MPa
(1 MPa = 10 bar = 147 PSI)	
Teplota horké vody:	max. 80 °C
Doporučení teplota horké vody:	65 °C
Teplotná desítkة:	max. 70 °C / 4 min

Vlastní jistiění proti zpětmému nasádk.

Výrobky Hansgrohe jsou vhodné pro přímý kontakt s pitnou vodou.

Popis symbolů



Nepoužívat silikon s obsahem kyseliny octové!

max. ≈ 42 °C Safety Function (viz strana 63)

Díky Safety Function je možné předem nastavit nevyšší požadovanou teplotu, např. max. 42°C.



Nastavení (viz strana 62)

Po ukončení montáže se musí zkontrolovat teplota vody vytékající z termostatu. Pokud se teplota změněná v místě odběru liší od teploty nastavené na termostatu, je nutné provést korekci:



Údržba (viz strana 66)

- Aby byl zajištěn lehký chod regulací jednotky, měl by se termostat čas od času nastavit na úplně horkou a úplně studenou vodu.
- Termostat je vybaven omezovacím zpětného toku. U zpětných ventilů se musí podle DIN EN 1717 v souladu s národními nebo regionálními předpisy testovat jejich funkčnost (alespoň jednou ročně).



Servisní díly (viz strana 69)

XXX = Kód povrchové úpravy
000 = chrom
090 = chrom/zlato ocel
820 = brushed nickel



Ovládací (viz strana 64)



Rozměry (viz strana 65)



Zkušební značka (viz strana 68)



Diagram průřoku

(viz strana 68)



Čištění

viz příložená brožura

Porucha

Příčina

Odstranění

Málo vody

- Nizký tlak v přívodu.
- Zanesený lapáč nečistot v reguláční jednotce
- Sítko v těsnění u sprchy zanesené
- Zkontrolovat tlak v potrubí
- Vyčistit lapáče nečistot před termostatem a na reguláční jednotce
- Vyčistit sítko v těsnění mezi sprchou a hadicí

Křížení toků, teplá voda se při zavřené armatuře tlačí do přívodu studené vody nebo naopak

- Znečištěný nebo netěsný zpětný ventil
- Zpětný ventil vyčistit, případně vyměnit

Teplota u výřoku nesusouhlasí s nastavenou teplotou

- Teplota u výřoku nesusouhlasí s nastavenou teplotou
- Nastavit termostat
- Nizká teplota teplé vody
- Teplotu horké vody zvýšit na 42°C až 65°C

Nelze regulovat teplotu

- Reguláční jednotka teploty znečištěná nebo zanesená vodním kamenem
- U nové instalace: obráceně připojené základní těleso (má být studená voda, teplá vlevo) nebo zabudované otočené o 180°
- Reguláční jednotku teploty vyčistit, případně vyměnit
- Funkční blok zabudovat otočený o 180°

Tlačítko bezpečnostní pojistky je nefunkční

- Vadná pružina
- Tlačítko zanesené vodním kamenem / znečištěné
- Pružinu nebo tlačítko očistit a lehce poříť tukem, případně vyměnit

Ciepka pracu zaworu sprcha nebo výtok odkapává

- horní uzavírací prvek poškozen
- Nečistoty nebo usazeniny na těsnícím sedle
- vyměnit horní uzavírací prvek
- vyčistit resp. vyměnit horní uzavírací prvek



Montáž viz strana 60



Bezpečnostné pokyny

- ▲ Pri montáži musíte nosiť rukavice, aby ste predišli pomliaždeninám a rezným poraneniam.
- ▲ Produkt sa smie používať len na kupanie a telesnú hygienu.
- ▲ Produkt nesmú bez dozoru používať deti, ako aj dospelé osoby s telesným, duševným a/alebo zmyslovým postihnutím. Produkt nesmú používať ani osoby, ktoré sú pod vplyvom alkoholu alebo drog.
- ▲ Veľké rozdiely v tlaku medzi pripojkami studenej a teplej vody musia byť vyrovnané.

Pokyny pre montáž

- Batéria sa musí montovať, preplochovať a testovať podľa platných noriem!
- Je potrebné dodržiavať smernice o inštalácii, ktoré sú práve teraz platné v krajinách.
- Pred montážou musíte produkt skontrolovať, či nebol počas transportu poškodený. Po zbudovaní nebudú uznané žiadne škody spôsobené transportom alebo poškodenia povrchu.

Technické údaje

Prevádzkový tlak:	max. 1 MPa
Doporučený prevádzkový tlak:	0,1 - 0,5 MPa
Skúšobný tlak:	1,6 MPa
(1 MPa = 10 bar = 147 PSI)	
Teplota teplej vody:	max. 80 °C
Doporučená teplota teplej vody:	65 °C
Termická dezinfekcia:	max. 70 °C / 4 min

Vlastná poisťka proti spätnému nasatiu.

Výrobok je koncipovaný výhradne pre pitnú vodu!

Popis symbolov



Nepoužívať silikón s obsahom kyseliny octovej!

max. Safety Function (viď strana 63)

≈ 42 °C

Vďaka Safety Function je možné vopred nastaviť najvyššiu požadovanú teplotu, napr. max. 42°C.



Nastavenie (viď strana 62)

Po ukončení montáže sa musí skontrolovať teplota vody vytekajúcej z termosiatu. Pokiaľ sa teplota nameraná na mieste odberu líši od teploty nastavenej na termosiate, je nutné vykonať korektúru.



Údržba (viď strana 66)

- Aby bol zaisťený ľahký chod regulačnej jednotky, mal by sa termosiat z času čas nastaviť na maximálne horúcu a maximálnu studenú vodu.
- Batéria je vybavená spätným uzáverom. Pri spätných ventiloch sa musí podľa DIN EN 1717 v súlade s národnými alebo regionálnymi predpismi testovať ich funkčnosť (aspoň raz ročne).



Servisné diely (viď strana 69)

XXX = Farebné označenie
000 = chróm
090 = chróm/zlato ocel
820 = brushed nickel

Obsluha (viď strana 64)





Rozmery (viď strana 65)



Osvedenie o skúške (viď strana 68)



Diagram prietoku

(viď strana 68)



Čistenie

nájdete v príloženej brožúre

Porucha	Príčina	Pomoc
Málo vody	<ul style="list-style-type: none"> - Nizký tlak v prívoде. - Zanesený lapač nečistôt v regulačnej jednotke - Sítka v tesnení sprchy je znečistené 	<ul style="list-style-type: none"> - Skontrolovať tlak v potrubí - Vyčistiť filter pred termostatom a na regulačnej jednotke - Vyčistiť sítka tesnení medzi sprchou a hadicou
Kríženie tokov, teplá voda sa pri uzavretej armatúre tlačí do prívodu študenej alebo naopak	<ul style="list-style-type: none"> - Znečistený alebo netesný spätný ventil 	<ul style="list-style-type: none"> - Spätný ventil vyčistiť, prípadne vymeniť
Teplota na výfuku nesúhlasí s nastavenou teplotou	<ul style="list-style-type: none"> - Nebol nastavený termostat - Nizka teplota teplej vody 	<ul style="list-style-type: none"> - Nastaviť termostat - Teplotu teplej vody zvýšiť na 42°C až 65°C
Nie je možné regulovať teplotu	<ul style="list-style-type: none"> - Regulačná jednotka teploty znečistená alebo zanesená vodným kameňom. - Pri novej inštalácii: naopak pripojené základné teleso (má byť studená vpravo, teplá vľavo) alebo zabudované otočené o 180° 	<ul style="list-style-type: none"> - Funkčný blok zabudovať o 180° - Regulačnú jednotku teploty vyčistiť, prípadne vymeniť
Tlačidlo bezpečnostnej poisťky je nefunkčné	<ul style="list-style-type: none"> - Vadná pružina - Tlačidlo zanesené vodným kameňom / znečistené 	<ul style="list-style-type: none"> - Pružinu alebo tlačidlo vyčistiť a zliatka potrieť tukom, prípadne vymeniť
Ventil s ťažkým pohybom	<ul style="list-style-type: none"> - Poškodená uzatváracia horná časť 	<ul style="list-style-type: none"> - Vymeniť uzatváraciu hornú časť
Sprcha alebo odtok kvapká	<ul style="list-style-type: none"> - Nečistoty alebo usadeniny na tesnení com sedle 	<ul style="list-style-type: none"> - Vyčistiť resp. vymeniť uzatváraciu hornú časť



Montáž viď strana 60



安全技巧

- △ 装配时为避免挤压和切割受伤，必须戴上手套。
- △ 淋浴系统只允许作为洗浴、卫生和洁身之用。不得让儿童和肢体、精神和/或意识有障碍的人在不受监督的情况下使用淋浴系统。受酒精或毒品影响的人员不得使用淋浴系统。
- △ 冷热水管间过大的压力差必须以平衡。

安装提示

- 必须按照现行的规定安装，冲洗和测试产品！
- 请遵守当地国家现行的安装规定。
- 安装前必须检查产品是否受到运输损害。安装后将不认可运输损害或表面损伤。

技术参数

工作压力:	最大 1 MPa
推荐工作压力:	0,1 – 0,5 MPa
测试压强:	1,6 MPa
(1 MPa = 10 bar = 147 PSI)	
热水温度:	最大 80°C
推荐热水温度:	65°C
热力消毒:	最大 70°C / 4 分钟

自动防止回流

该产品专为饮用水设计！

符号说明



请勿使用含有乙酸的硅！

max.
≈ 42°C

安全功能 (参见第页 63)

恒温阀芯的安全功能可以预先设定所希望的最高出水温度，例如最高温度为42°C



校准 (参见第页 62)

安装完成后必须检查调温器的出水温度。如在取水处测量所得的温度与调温器上设定的温度有偏差，那么必须进行



保养 (参见第页 66)

- 为了保证恒温器的稳定运转，请务必定期从最热到最冷转动调温器。
- 此恒温龙头带有单向阀。单向阀必须在符合国家或当地的法律的情况下按照DIN EN 1717定期检查（至少一年一次）。



备用零件 (参见第页 69)

XXX = 颜色代码
000 = 镀铬
090 = 镀铬/黑色
820 = 银拉丝



操作 (参见第页 64)



大小 (参见第页 65)

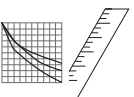

检验标记 (参见第页 68)

流量示意图
(参见第页 68)清洗
附有小手册

问题	原因	补救
龙头出水量小	<ul style="list-style-type: none"> - 水压不足 - 调压器过滤网脏污 - 花洒滤网有垃圾堵塞 	<ul style="list-style-type: none"> - 检查总水压 - 清洁龙头前面和MTC恒温阀芯的过滤网 - 清洗花洒和软管间的过滤密封件
单水, 在龙头关闭的状态下, 热水被强迫流入冷水管路, 或者相反。	<ul style="list-style-type: none"> - 单向阀有垃圾堵塞或漏水 	<ul style="list-style-type: none"> - 清洗单向阀, 如有必要则更换新的
龙头出水温度和温度设定的不符	<ul style="list-style-type: none"> - 恒温器未被调节 - 热水温度过低 	<ul style="list-style-type: none"> - 调节恒温器 - 将热水温度从42°C升高到65°C
水温无法调节	<ul style="list-style-type: none"> - 温度调节器脏污或结垢 - 对于新的安装: 基体连接不正确 (可能是: 右冷, 左热) 或者安装时旋转180° 	<ul style="list-style-type: none"> - 清洗温度调节器, 视需要更换 - 安装功能块时, 旋转180°
安全停止按钮不工作	<ul style="list-style-type: none"> - 弹簧损坏 - 按钮老化 / 脏污 	<ul style="list-style-type: none"> - 清洁弹簧和 / 或按钮, 并视需要更换
阀门不灵活	<ul style="list-style-type: none"> - 关闭部件损坏 	<ul style="list-style-type: none"> - 更换关闭部件
花洒或龙头出水嘴滴水	<ul style="list-style-type: none"> - 在阀体上有灰尘或水垢, 阀芯损坏 	<ul style="list-style-type: none"> - 清洗或更换闭锁阀芯



安装 参见第页 60



Указания по технике безопасности

Описание символов

Во время монтажа следует надеть перчатки во избежание прищемления и порезов.



Не применяйте силикон, содержащий искусную кислоту.

Изделие разрешается использовать только в гигиенических целях: для принятия ванны и личной гигиены.

max. $\approx 42^{\circ}\text{C}$
Safety Function (см. стр. 63)

С помощью функции Safety Function может быть задана максимальная температура воды, например 42°C .

Дети, а также взрослые с физическими, умственными и/или сенсорными недостатками должны пользоваться изделием только под присмотром. Запрещается пользоваться изделием в состоянии алкогольного или наркотического опьянения.



Настройка (см. стр. 62)

Перед установкой смесиителя необходимо регулировочными кранами выровнять давление холодной и горячей воды при помощи вентилей регулирующих подачу воды в квартиру.

Указания по монтажу

- Смеситель должен быть смонтирован по действующим нормам и в соответствии с настоящей инструкцией, проверен на герметичность и безупречность работы
- Необходимо соблюдать требования по монтажу, действующие в соответствующих странах.
- Перед монтажом следует проверить изделие на предмет поврежденный при перевозке. После монтажа претензии о возмещении ущерба за повреждение при перевозке или повреждении поверхностей не принимаются.



Техническое обслуживание
(см. стр. 66)

- Для гарантии плавного изменения температуры и долгого срока службы необходимо периодически поворачивать ручку регулировки температуры из положение максимально горячей в положение максимально холодной вода.

Технические данные

Рабочее давление: не более, 1 МПа
Рекомендуемое рабочее давление: 0,1 - 0,5 МПа
Давление: 1,6 МПа (1 МПа = 10 bar = 147 PSI)
Температура горячей воды: не более, 80°C
Рекомендуемая темп. гор. воды: 65°C
Термическая дезинфекция: не более, 70°C / 4 мин
Укомплектован клапаном обратного тока воды



Комплект (см. стр. 69)

XXX = Цветная кодировка
000 = хром
090 = хром/глянцевое золото
820 = brushed nickel

Изделие предназначено исключительно для питьевой воды!



Эксплуатация (см. стр. 64)



Размеры (см. стр. 65)



Знак технического контроля
(см. стр. 68)



Схема потока
(см. стр. 68)



Очистка
см прилагаемая брошюра

Неисправность

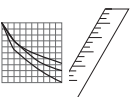
Причина

Устранение неисправности

недостаточный давление (если
устан напор воды)

- Проблемы водоснабжения

- Проверить овлен насос прове-
рить работу насоса

- Фильтр термозлемента загрязнен

- Очистите грязе/лавиляющие
ситя перед термостатом и на
регуляторе

- Фильтр душа загрязнен

- Очистить фильтр

Подмес воды, в закрытом положении
горячая вода стремится в подводуку
холодной воды или наоборот

- Клапан обратного тока воды загряз-
нен или неисправен при необходи-
мости

Температура смешанной воды не
соответствует шкале

- Термостат не настроен - Настроить термостат
- Температура горячей воды слишком
высока - Поднять температуру горячей
воды с 42 град.С до 65 град.С

Регулировка температура не
производится

- Термозлемент загрязнен или покрыт
известью - Очистить термозлемент при
необходимости заменить термо-
элемент

- для вновь установленного изделия:
ошибка установки, холод на вода
подводится справа горячей слева,
или установлено с 180 град пово-
ротом. - повернуть внутренний блок

Красная кнопка защиты от ожога
не работает

- Лезно пружины кнопки - Очистите пружину или кнопку и
- Нажимная кнопка имеет известко-
вые отложения/загрязнено слезка смажьте, при необходи-
мости замените

Вентиль заедает

- Верхняя часть отключающего
устройства повреждена - Заменить
часть отключающего устройства

Из душа или выхода капает вода

- Загрязнения или отложения на
уплотнительном кольце, верхняя
часть запора повреждена - Очистите или замените верхнюю
часть отключающего устройства



Монтаж см. стр. 60



Biztonsági utasítások

- ▲ A szerelésnél a zúzdások és vágási sérülések elkerülése érdekében kesztyűt kell viselni.
 - ▲ A terméket csak fürdéshez, mosakodáshoz, és egészségügyi tisztálkodáshoz szabad használni.
 - ▲ Gyermekek, valamint testileg, szellemileg fogyatékos és / vagy érzékelésben korlátozott személyek nem használhatják felügyelet nélkül a terméket. Alkohol és kábitószer befelvétele alatt álló személyek nem használhatják a terméket.
 - ▲ A hidegvíz- és a melegvízcsatlakozások közötti nagy nyomáskülönbséget kikéll egyenlíteni!
- ### Szerelési utasítások
- A csatléplepet az érvényben lévő előírásoknak megfelelően kell felszerelni, átöblíteni és ellenőrizni!
 - Az egyes országekban érvényes installációs irányelveket be kell tartani.
 - A szerelés előtt ellenőrizni kell, hogy a termékek nincse szállítási sérülése. Beépítés után a szállítási- vagy felületi sérüléseket nem ismerik el.

Műszaki adatok

Üzemi nyomás:	max. 1 MPa
Ajánlott üzemi nyomás:	0,1 - 0,5 MPa
Nyomáspróba:	1,6 MPa
(1 MPa = 10 bar = 147 PSI)	
Forróvíz hőmérséklet:	max. 80 °C
Forróvíz javasolt hőmérséklete:	65 °C
Termikus fertőtlenítés:	max. 70 °C / 4 perc
Visszafolyás gátlóval	
A terméket kizárólag ivóvízhez tervezétki	

Szimbólumok leírása



max. 42 °C
Safety Function (Biztonsági funkció) (lásd a oldalon 63)

Ne használjon ecetsavtartalmú szilikonit!

A biztonsági funkciónak köszönhetően a kívánt hőmérsékletet pl. 42 Celsius fokban maximálhatjuk.



Beszereles (lásd a oldalon 62)

A sikeres felszerelést követően ellenőrizni kell a termosztát kifolyási hőmérsékletét. Helyeshítés szükséges, ha a vizkivétel helyén mért hőmérséklet elér a termosztáton beállított hőmérsékletől.



Karbantartás (lásd a oldalon 66)

- Ahhoz, hogy a szabályozóegység jól működjön, a termosztátot időről időre teljesen melegre és teljesen hidegre kell állítani.
- A termosztát visszafolyás-gátlóval van felszerelve. A visszafolyásgátlók működése a DIN EN 1717 szabványrak megfelelően, a nemzeti vagy területi rendelkezésekkel összhangban, évente egyszer ellenőrizendő!



Tartozékok (lásd a oldalon 69)

XXX = Színkódolás
000 = króm
090 = króm/arany-hatású
820 = brushed nickel

Használat (lásd a oldalon 64)





Méretet (lásd a oldalon 65)



Vizsgajel (lásd a oldalon 68)

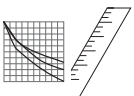

Átfolyási diagramm

(lásd a oldalon 68)



Tisztítás

lásd a mellékelt brosúrát

Hiba

Kevés víz

Ok

- a nyomás nem megfelelő

Megoldás

- a vezetékek nyomását ellenőrizni kell

- a szabályozóegység szennyeződést felfogó szűrője koszos

- A termosztát elött és a szabályozó egységen lévő szennyfogó szűrők megtisztítása

- A zuhany szűrőtömlője koszos

- A zuhany és a cső közötti szűrőt ki kell tisztítani

Keresztfoltyás, a melegvíz a csop zárt állapotában a hidegvíz vezetékebe áramlik és fordíva

- a visszatöltésgátló piszkos vagy hibás

- a visszatöltésgátlót tisztítani kell ill. ki kell cserélni

A kifolyóvíz hőmérséklete nem egyezik a termosztáton beállított hőmérséklettel

- a termosztát nem lett be szabályozva
- túl alacsony melegvíz hőmérséklet

- a termosztátot be kell szabályozni
- a melegvíz hőmérsékletét 6,5 fokra kell felemléni

Nem lehetséges a hőmérsékletszabályozás

- a hőmérséklet szabályozóegység koszos vagy vízköves
- Újrainstallálásnál az alaptel rosszul csatlakozik (a hideget jobbra, a meleget balra vagy 180 fokkal elforgatva kell beszerelni)

- a szabályozó egységet tisztítani ill cserélni kell
- A funkcióblokkot 180 fokkal való elforgatás után beszerelni.

A biztonsági zár nyomógombja nem működik

- a rugó hibás
- A nyomógomb vízköves / szennyezett

- a rugót ill. a nyomógombot ki kell tisztítani és enyhén be kell zsírítani ill. ki kell cserélni

Szelep nehezen jár

- Elzáró felső része sérült

- Elzáró felső részét kicserélni

A zuhany vagy a kifolyó csepeg

- Piszok vagy lerakódások a tömítés alatt, sérült az elzáró felső része

- Elzáró felső részét megtisztítani, ill. kicserélni



Szerelés lásd a oldalon 60



Turvallisuusohjeet

- ▲ Asennuksessa on käytettävä käsinettä puristurien ja villiöiden aiheuttamien tapaturmien estämiseksi.
 - ▲ Suihkujärjestelmää saa käyttää ainoastaan kylpy-, hygienia- ja puhdistusarkoituksiin.
 - ▲ Lapset ja ruumiillisesti henkisesti ja/tai aistillisesti rajoittuneet aikuiset eivät saa käyttää suihkujärjestelmää ilman valvontaa. Alkoholin tai huumeiden vaikutuksessa olevat henkilöt eivät saa käyttää suihkujärjestelmää.
 - ▲ Suuret paine-erot kylmä- ja kuumavesiliitäntöjen välillä on tasattava.
- ### Asennusohjeet
- Kaluste on asennettava, huuhdeltava ja tarkastettava voimassa olevien määräysten mukaisesti!
 - Jokaisessa maassa on noudatettava sillä päteviä asennusohjeita.
 - Ennen asennusta on tarkastettava tuoteen mahdolliset kuljetusvahingot. Asennuksen jälkeen kuljetus- ja pintavaurioita ei hyväksytä.

Tekniset tiedot

Käyttöpaino:	maks. 1 MPa
Suosittelu käyttöpaino:	0,1 - 0,5 MPa
Koestuspaine:	1,6 MPa
(1 MPa = 10 bar = 147 PSI)	
Kuuman veden lämpötila:	maks. 80 °C
Kuuman veden suosituslämpötila:	65 °C
Lämpödesinfiکتio:	maks. 70 °C / 4 min

Esitä ääriäsiä paluuvirtauksen

Tuote on suunniteltu käytettäväksi ainoastaan juomaveden kanssa!

Merkin kuvaus



Älä käytä etikkahappoista silkkonia!

max. 42 °C
Safety Function (katso sivu 63)

Safety Function:ista johtuen haluttu maksimilämpötila voidaan esiasettaa, esimerkiksi maks. 42° C.



Säätö (katso sivu 62)

Asennuksen jälkeen termostaatin ulostuloämpötila on tarkastettava. Säätö on tarpeen, jos käyttöasteessa mitattu veden lämpötila eroaa termostaattiin säädetyistä lämpötilasta.



Huolto (katso sivu 66)

- Säätyöskikon kevytkäyttöisyyden takaamiseksi, säätö säätöyksikköä ajoittain täysin kynnölle ja täysin kuumalle.
- Termostaatti on varustettu vastaventtiileillä. Vastaventtilien toiminta on tarkastettava säännöllisesti paikallisten ja kansallisten määräysten mukaisesti (DIN 1988, kerran vuodessa).



Varaosat (katso sivu 69)

XXX = Värikooodaus
000 = kromi
090 = kromi/kulhaoptiikka
820 = harjattu nikkelä



Käyttö (katso sivu 64)



Mitat (katso sivu 65)

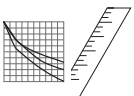

Virtausdiagrammi

(katso sivu 68)



Koestusmerkki (katso sivu 68)



Puhdistus

katso oikeinen esite

Häiriö

Vähän vettä

Syy

Toimenpide

- Syöttöpaine ei ole riittävä	- Tarkasta putkiston paine
- Lämpötilan säätöyksikön ilkasihiti likaantunut	- Puhdista termostaatin ja säätöyksikön ilkasihidi
- Käsisuihkun sihttiiviste likaantunut	- Puhdista suihkukehyan ja letkun välisistä oleva sihttiiviste
- Suuntaisventtiili likaantunut / viadlinen	- Puhdista suuntaisventtiili, vaihda tarvittaessa

Risitiivirtaus, hanon ollessa kiinni lämmin vesi pääsee virtaamaan kylmänveden putkeen tai päinvastoin.

- Termostaattia ei ole säädetty	- Säädä termostaatti
- Lämminveden lämpötila liian alhainen	- Kohota lämminveden lämpötila arvoon välillä 42°C ja 65°C

Lämpötilan säätö ei ole mahdollista

- Lämpötilansäätöyksikkö likaantunut tai kalkkeutunut	- Puhdista lämpötilansäätöyksikkö, vaihda tarvittaessa
- Litokset perusrunkoon on asennettu väärin väärin (pitää olla: kylmä oikealla, lämmin vasemmalla) tai perusrunko on asennettu 180° käännettyä	- Asenna toimintaloikko 180° käännetyinä paikalleen

Veden lämpötilan turvavaojittimen painonappi ei toimi

- Jousi ei toimi	- Puhdista ja vaihda kevyesti jousi ja/tai painonappi, vaihda tarvittaessa
- Painonappi kalkeutunut/ilkaainen	- Puhdista tai vaihda sulkuventtiilin etuosaa vahingoittamatta

Venttiili rasakkakäyttöinen

- Sulkuventtiilin etuosaa vahingoittanut	- Vaihda sulkuventtiilin etuosaa
- Likaa tai kerrostunutta hiivisestisubkassa, sulkuventtiilin etuosaa vahingoittanut	- Puhdista tai vaihda sulkuventtiilin etuosaa

Käsisuihkusta tai hanasta tippuu vettä



Asennus katso sivu 60



Sakerhetsanvisningar

- △ Handskar ska baras under monteringsarbetet s att man kan undvika kim- och skarskadorna vid tvat.
- △ Produkten far bara anvandas till kroppshygien med bad och dusch.
- △ Barn samt vuxna med fysiska, psykiska eller sensoriska funktionshinder far inte anvanda produkten ensamman. Personer som ar paverkade av alkohol eller droger far inte anvanda produkten.
- △ Stora tryckskillnader mellan anslutningarna for varmt och kallt vatten maste utjammas.

Monteringsanvisningar

- Blandaren maste installeras, genomspolas och testas enligt gallande foreskrifter.
- De installationsriktlinjer som galler i landerna ska foljas.
- Det moste undersokas om produkten har transportskadorna innan den monteras. Efter monteringen accepteras inga transport- eller ytskadorna.

Tekniska data

Driftstryck:	max. 1 MPa
Rek. driftstryck:	0,1 - 0,5 MPa
Tryck vid provtryckning: (1 MPa = 10 bar = 14,7 PSI)	1,6 MPa
Varmvattentemperatur:	max. 80 °C
Rek. varmvattentemp.:	65 °C
Termisk desinfektion:	max. 70 °C / 4 min

Stakspar mot erflode

Produkten ar enbart avsedd for dricksvatten!

Symbolforklaring



Anvand inte silikon som innehaller attiksyra!

max. ≈ 42 °C Safety Function (se sidan 63)

Med hjalp av Safety Function kan du stalla in den onskade maximaltemperaturen till exempelvis 42°C och sa forhindra skallningsrisk for barn.



Installning av maxtemperatur (se sidan 62)

Nar monteringen ar klar maste termostatsens formingstemperatur kontrolleras. En justering ar nodvandig om den uppmatta temperaturen vid tappningsstallet avviker fran den som ar installad pa termostaten.



Skotsel (se sidan 66)

- For att garantera att termostaten ej kalkar igen, ska den regelbundet, en gang per vecka, konditioneras. Det sker genom att man nagra ganger snabbt sats om temperaturen fran hett till kallt och tillbaka.
- Termostaten ar utrustad med backventiler. Backventilens funktion maste kontrolleras regelbundet enligt nationella eller regionala bestammelser (DIN 1988 en gang per ar) i enlighet med DIN EN 1717.



Reservdelar (se sidan 69)

XXX = Fargkodning
000 = krom
090 = krom/guld-optik
820 = borstad nickel



Hantering (se sidan 64)

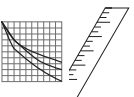

Måtten (se sidan 65)

Flödesschema

(se sidan 68)



Testsigill (se sidan 68)



Rengöring

se den medföljande broschyren

Störning	Orsak	Åtgärd
För lite vatten	<ul style="list-style-type: none"> - Vattentrycket är för lågt - Smutsfilter i styrenheten igensatt 	<ul style="list-style-type: none"> - Kontrollera ledningstryck - Rengör smutsfilren vid inloppen och på termosenorn
Korsflöde – varmt vatten pressas vid avstängd emostat in i kallvatten-inloppet, och vice versa	<ul style="list-style-type: none"> - Silffilret i duschen smutsigt 	<ul style="list-style-type: none"> - Rengör silffilret mellan slangen och termostaten
Den faktiska vatten-temperaturen stämmer inte överens med den inställda	<ul style="list-style-type: none"> - Termostaten ställs inte in - Varmvattentemperaturen är för låg 	<ul style="list-style-type: none"> - Justera termostaten - Höj varmvattentemperaturen till mellan 42°C och 65°C
Temperaturen kan ej ställas in	<ul style="list-style-type: none"> - Temperaturinställning smutsig eller täckt av kalk - Grundkonstruktionen anslöts på fel sätt vid nyinstallation (ska vara: kall höger, varmt vänster) eller monterades med 180° förskjutning 	<ul style="list-style-type: none"> - Rengör temperaturinställningen, byt ut om nödvändigt - Montera funktionslocket med 180° förskjutning
Tryckknappen till säkerhetspärren har ingen funktion	<ul style="list-style-type: none"> - Fjäder defekt - Tryckknapp täckt av kalk / smutsig 	<ul style="list-style-type: none"> - Rengör fjäder eller tryckknapp och smörj in något, eller byt ut om detta behövs
Ventil trög	<ul style="list-style-type: none"> - Avstängningsventil defekt 	<ul style="list-style-type: none"> - Byt ut avstängningsventil
Det droppar ur handdusch eller utloppspip till kar	<ul style="list-style-type: none"> - Smuts eller avlagringar på packningen, överdelen på avstängningsventilen är skadad 	<ul style="list-style-type: none"> - Rengör eller byt överdelen av avstängningsventilen



Montering se sidan 60



Saugumo technikos nurodymai

- ⚠ Apsaugai nuo užspaudimo ir įsijpiovimo montavimo metu mūvėkite pirštines.
- ⚠ Gaminys turi būti naudojamas tik maudymuisi, kūno higienai ir švarai palaikyti.
- ⚠ Gaminio draudžiama naudoti vaikams, taip pat suaugusiems su fizine, dvasine negale ir (arba) sensorikos sutrikimais. Gaminį taip pat draudžiama naudoti asmenims, apsvaigusiems nuo alkoholio arba narkotikų.

⚠ Turi būti išlyginti šalto ir karšto slėgio nelygumai.

Montavimo instrukcija

- Maišytuvus privalo būti montuojamas, išleidžiamas ir patikrinamas pagal galiojančias normas!
- Laikykites atitinkamoje šalyje galiojančių direktyvų dėl įengimo.
- Prieš montuojant būtina patikrinti, ar gaminys nebuvo pažeistas transportavimo metu. Sumontavus pre-tenzijos dėl transportavimo ir paviršiaus pažeidimų nepriimamos.

Techniniai duomenys

Darbinis slėgis:	ne daugiau kaip 1 MPa
Rekomenduojamas slėgis:	0,1 - 0,5 MPa
Bandomasis slėgis:	1,6 MPa
(1 MPa = 10 barų = 147 PSI)	
Karšto vandens temperatūra:	ne daugiau kaip 80 °C
Rekomenduojama karšto vandens temperatūra:	65 °C
Terminis dezinfekavimas: ne daugiau kaip	70 °C / 4 min

Su atbuliniu vožtuvu

Produktas skirtas tik geriamajam vandeniui!

Simbolio aprašymas



Nenaudokite silkono, kurio sudėtyje yra acto rūgšties!

max. ≈ 42 °C
Apsaugos funkcija (žr. psl. 63)

"Safety" funkcija karšto vandens temperatūra gali būti iš anksto ribota iki, pvz., ne aukštesnės kaip 42 °C.



Nustatymas (žr. psl. 62)

Sumontavus, būtina patikrinti vandens, išėjimo naščio iš termostato, temperatūrą. Pakoreguokite vandens temperatūrą, jei būtina.



Techninis aptarnavimas (žr. psl. 66)

- Tam, kad būtų garantuotas tolygus temperatūros reguliavimas ir ilgas naudojimasis, būtina periodiškai temperatūros rankenėlę pasukti į karštesnį arba šaltesnį temperatūros padėtį.
- Termostatas yra su grįžtamąsios srovės sustabdymo vožtuvais. Atbulinio vožtuvo apsauga privalo būti tikrinama reguliariai (mažiausiai kartą per metus pagal DIN 1988) pagal DIN EN1717 arba pagal galiojančias nacionalines arba regionines normas.



Atsarginės dalys (žr. psl. 69)

XXX = Spalvos
000 = chrom
090 = chrominė (aukso optika)
820 = brushed nickel

Eksploatacija (žr. psl. 64)





Išmatavimai (žr. psl. 65)



Bandymo pažyma (žr. psl. 68)



Pralaidumo diagrama

(žr. psl. 68)



Valymas

žr. pridedamoje brošiūroje

Gedimas

Per mažą srovę

Priežastis

Priemonė

- Slėgis nepakankamas
- Užsikimšęs temperatūros reguliatoriaus filtras
- Dušo galvos filtras užsikimšęs

- Patikrinti vamzdžių spaudimą
- Išvalyti termostato ir temperatūros reguliatoriaus filtrus
- Išvalyti dušo galvos filtrą

Kryžminis tekėjimas, uždarčius maišytuvą, karštas vanduo popuola į šalto vandens vamzdį

- Atbulinis vožtuvas užsikimšęs / pažeistas
- Išvalyti arba pakeisti atbulinį vožtuvą

Vandens temperatūra nesutampa su nustatyta temperatūra

- Termostatas nereguliuotas
- Per mažą karšto vandens temperatūra
- Reguliuoti termostatą
- Karšto vandens temperatūrą pakelti nuo 42 °C bis 65 °C

Temperatūros reguliavimas neįmanomas

- Temperatūros reguliatorius užsikimšęs arba apkalbėjęs
- Išvalyti arba pakeisti temperatūros reguliatorių

- Neteisingai prijungti vamzdžiai: karštas turi būti katirėje, šaltas - dešinėje
- Sumontuoti funkcijos blokavimų

Ribotuvo mygtukas neveikia

- Spnyruoklė pažeista
- Užkalkeio / užsiteršę kontaktinis mygtukas
- Išvalyti spnyruoklę/mygtuką ir sutepti arba keisti

Ventilis sunkiai valdomas

- Pažeistas ventilis
- Pakeisti ventilį

Laša iš čiaupo arba dušo galvos arba pažeistas uždarymo dalis

- Nešvarumai, kalkės ant guminių dalių
- Išvalyti arba pakeisti ventilį



Montavimas žr. psl. 60



Sigurnosne upute

- ▶ Prilikom montaže se radi sprječavanja prignječanja i posjekotina moraju nositi rukavice.
- ▶ Proizvod se smije primjenjivati samo za kupanje, tuširanje i osobnu higijenu.
- ▶ Dieca, kao i tijelaso, mentarno i/ili senzorno hendikepirane odrasle osobe ne smiju se koristiti proizvodom bez nadzora. Osobe koje su pod utjecajem alkohola ili droga ne smiju se koristiti proizvodom.
- ▶ Velika razlika u pritisku između vruće i hladne vode mora biti izbalansirana.

Upute za montažu

- Gijevi moraju biti postavljene, isprane i testirane prema važećim normama!
- Obvezno se moraju uvaziti propisi o instalacijama koji vrijede u dotičnoj zemlji.
- Prije montaže mora se provjeriti je li proizvod oštećen prilikom transporta. Nakon ugradnje se ne priznaju nikakve reklamacije koje se odnose na površinska i transportna oštećenja.

Tehnički podaci

- Najveći dopušteni tlak: tlak 1 MPa
Preporučeni tlak: 0,1 - 0,5 MPa
Probni tlak: 1,6 MPa
(1 MPa = 10 bar = 147 PSI)
Temperatura vruće vode: tlak 80 °C
Preporučena temperatura vruće vode: 65 °C
Temtička dezinfekcija: tlak 70 °C / 4 min
- Funkcije samo-čišćenja
- Proizvod je koncipiran isključivo za pitku vodu!

Opis simbola



Nemojte koristiti silikon koji sadži octenu kiselinu!

max. ≈ 42 °C 63) **Safety Funkcija** (pogledaj stranicu

Zahvaljujući Safety funkciji može se podestiti željena maksimalna temperatura, npr. : 42 °C



Regulacija (pogledaj stranicu 62)

Nakon instalacije treba ispitati izlaznu temperaturu termostata. Korekcija je neophodna, ako izmjerena temperatura na mjestu uzimanja odstupa od temperature koja je namještena na termostatu.



Održavanje (pogledaj stranicu 66)

- Kako bi se olakšala prohodnost i produ-ljio vijek trajanja regulacijske jedinice, potrebno je s vremena na vrijeme podestiti termostat iz položaja maksimalno tople u položaj maksimalno hladne vode.
- Termostat je opremljen nepovratnim ventilom. Ispravnost nepovratnog ventila mora se redovito provjeravati prema standardu DIN EN 1717 i u skladu sa važećim propisima (najmanje jednom godišnje).



Rezervni dijelovi (pogledaj stranicu 69)

- XXX = Boje
- 000 = krom
- 090 = optika krom/zlato
- 820 = brushed nickel



Upotreba (pogledaj stranicu 64)



Mjere (pogledaj stranicu 65)



Oznaka testiranja (pogledaj stranicu 68)



Diagram protoka

(pogledaj stranicu 68)



Čišćenje

se u priloženoj brošuri

Greška

Nedovoljno vode

Uzrok

- Prenizak pritisak vode
- Očistite rešetkasti filter regulacijske jedinice
- Filter tuša je prljav
- Nepovratni ventil je prljav/neispravan
- Križni tok vode, kod zatvorene armature vruća voda ulazi u cijev s hladnom vodom i obrnuto

Otklanjanje

- Ispitajte tlak u cijevima
- Očistite rešetkasti filter ispred termostata i na regulacijskoj jedinici
- Očistite filter između tuša i cijeva
- Očistite ili zamijenite nepovratni ventil

Temperatura na slavini ne podudara se s podešenom temperaturom

- Termostat nije podešen

- Preniska temperatura tople vode

- Podesite termostat
- Povećajte temperaturu vruće vode na 42-65 °C

Reguliranje temperature nije moguće

- Regulator temperature je prljav ili obložen naslagama kamenca

- Očistite ili zamijenite regulator temperature.

- Pri ponovnoj instalaciji tijelo je pogrešno priključeno (potrebno je priključiti hladnu vodu desno, a vruću lijevo) ili je zakrenuto za 180 stupnjeva.

- Unutarnji blok okretne za 180 stupnjeva

Tipkalo sigurnosnog prekida je van funkcije

- Opruga je neispravna
- Gumb je začepljen naslagama kameca ili prljav

- Očistite i podmažite oprugu, tipkalo, u slučaju potrebe tipkalo možete zamijeniti novim

Ventil je neprohodan

- Gornji dio ventila za zatvaranje je oštećen

- Zamijenite gornji dio ventila za zatvaranje

Tuš ili slavina kaplje

- Prljavšina ili naslage kamenca na ventilima, gornji dio ventila za zatvaranje je oštećen

- Očistite, tj. zamijenite gornji dio ventila za zatvaranje



Sastavljanje pogledaj stranicu 60



Türkçe

⚠ Güvenlik uyarıları

- Montaj esnasında ezilme ve kesilme gibi yaralanmaların önlemek için eldiven kullanılmalıdır.
- Düş sistemi yalnızca banyo, hijyen ve beden temizliği amaçları doğrultusunda kullanılabilir.
- Bedensel, ruhsal ve/veya sensorik engelli çocuk ve yetişkinler gözetimsiz olarak düş sistemini kullanmamalıdır. Alkol veya uyuşturucu etkisinde olanlar düş sistemini kullanmamalıdır.
- Sıcak ve soğuk su bağlantıları arasında büyük basınç farklılıkları varsa, bu basınç farklılıklarının dengelenmesi gerekir.
- Batarya geçerli normlara göre monte edilmeli, yankonali ve kontrol edilmelidir!
- Ülkelerde geçerli kurulum yönetmeliklerine riayet edilmelidir.
- Montaj işleminden önce ürün nakliye hasarları yönünden kontrol edilmelidir. Montaj işleminden sonra nakliye veya yüzey hasarları için sorumluluk üstlenilmemektedir.

Montaj açıklamaları

- İşletme basıncı: azami 1 MPa
 - Tavsiye edilen işletme basıncı: 0,1 - 0,5 MPa
 - Kontrol basıncı: 1,6 MPa
 - (1 MPa = 10 bar = 147 PSI)
 - Sıcak su sıcaklığı: azami 80 °C
 - Tavsiye edilen su ısısı: 65 °C
 - Termik dezenfeksiyon: azami 70 °C / 4 dak
 - Geri emme önleyici
- Ürün sadece şebeke suyu için tasarlanmıştır!

Simge açıklaması



Asetik asit içeren silikon kullanmayınız!

max. ≈ 42 °C Safety Function (bakınız sayfa 63)

Emniyet fonksiyonu sayesinde, istenen maksimum sıcaklık Öm. maks. 42° C önceden ayarlanabilir.



Ayarlama (bakınız sayfa 62)

Montaj tamlandıktan sonra, termostatların çıkış sıcaklığı kontrol edilmelidir. Alma noktasında ölçülen sıcaklık termostatta ayarlanan sıcaklıktan farklıysa, bir düzeltme gereklidir.



Bakım (bakınız sayfa 66)

- Ayar ünitesinin kolay hareket etmesini sağlamak için, termostat belirli aralıklarla tamamen sıcak ve soğuk konuma getirilmelidir.
- Termostat, çek valflerle donatılmıştır. DIN EN 1717 ve ulusal standartlar doğrultusunda Çek valfler düzenli olarak kontrol edilmelidir. (en az yılda bir kez)



Yedek Parçalar (bakınız sayfa 69)

- XXX = Renkler
- 000 = krom
- 090 = krom/alın-optik
- 820 = brushed nickel

Kullanımı (bakınız sayfa 64)





Ölçüleri (bakınız sayfa 65)



Kontrol İşareti (bakınız sayfa 68)

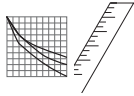

Akış diyagramı

(bakınız sayfa 68)



Temizleme

birlikte verilen broşür

arıza	sebep	yardım
Az su geliyor	- Besleme basıncı yeterli değil - Ayar ünitesinin filtresi kirlenmiş	- Hat basıncını kontrol edin - Termostatın önündeki ve ayar ünitesindeki filtreleri temizleyin
Çapraz akış, batarya kapalıyken sıcak su soğuk su hattına gönderiliyor ya da tam tersi	- Düşün süzgeci tıkanmış olabilir	- El düşü ile hortum arasındaki hortumu yıkayın
Çapraz akış, batarya kapalıyken sıcak su soğuk su hattına gönderiliyor ya da tam tersi	- Çek valf kirlenmiş / arızalı	- Çek valfi temizleyin ya da değiştirin
Çiğış sıcaklığı ayarlanan sıcaklıkla aynı değil	- Termostat ayarlanmadı - Sıcak suyun derecesi çok düşük	- Termostatı ayarlayın - Sıcak su sıcaklığını 42 °C'ile 65 °C'ye yükseltin
Sıcaklık ayarı mümkün değil	- Sıcaklık ayar ünitesi kirlenmiş ya da kireçlenmiş - Yeni montaj sırasında ana gövde yanlışı bağlanmış (Olmaması gereken: soğuk sağ tarafta, sıcak sol tarafta) ya da 180° döndürülerek takılmış	- Sıcaklık ayar ünitesini temizleyin, gerekirse değiştirin - Fonksiyon bloğunu 180° döndürerek takın
Emniyet kilitinin düğmesi çalışmıyor	- Yay arızalı - Düğme kireçlenmiş / kirlenmiş	- Yayı ya da düğmeyi temizleyin ve hafifçe gres sürün, gerekirse değiştirin
Valf zor hareket ediyor	- Kesici üst parçası zarar görmüş - Conta yuvasında kir ya da tortu, kesme üst parçası hasar görmüş	- Kesici üst parçasını değiştirin - Kesici üst parçasını temizleyin veya değiştirin



Montajlı bakımınız sayfa 60



Instrucțiuni de siguranță

- ▶ La montare utilizați mânuși pentru evitarea contuziunilor și tăierii mâinilor.
- ▶ Sistemul de duș poate fi utilizat doar pentru spălarea, menținerea igienei și curățarea corpului.
- ▶ Copiii și adulții cu dizabilități corporale, mintale și senzoriale nu pot utiliza sistemul de duș nesupravegheați. De asemenea este interzisă utilizarea sistemului de duș de către persoane, care se află sub influența alcoolului sau a drogurilor.
- ▶ Diferențele de presiune mari între alimentarea cu apă rece și apă caldă trebuie echilibrate.

Instrucțiuni de montare

- Bateria trebuie montată, clătită și verificată conform normelor în vigoare.
- Respectați reglementările referitoare la instalare valabile în țara respectivă.
- Înainte de instalare verificați, dacă produsul prezintă deteriorări de transport. După instalare garanția nu acoperă deteriorările de transport și cele de suprațea.

Date tehnice

Presiune de funcționare:	max. 1 MPa
Presiune de funcționare recomandată:	0,1 - 0,5 MPa
Presiune de verificare:	1,6 MPa
(1 MPa = 10 bar = 147 PSI)	
Temperatura apei calde:	max. 80 °C
Temperatura recomandată a apei calde:	65 °C
Dezinfecție termică:	max. 70 °C / 4 min

Asigurați-vă că apă caldă este disponibilă.

Produsul este destinat exclusiv pentru apă potabilă.

Descrierea simbolurilor



Nu utilizați silicon cu conținut de acid acetic!

max. 42 °C
≈ 42 °C (63) **Funcția de siguranță** (vezi pag.

Datorită funcției de siguranță puteți regla temperatura maximă, de ex. 42 °C.



Reglare (vezi pag. 62)

După montare verificați temperatura de ieșire la termosat. În cazul în care există o diferență între temperatura măsurată la goleră și temperatura reglată la termosat trebuie efectuată o corecție.



Întreținere (vezi pag. 66)

- Pentru garantarea mișcării ușoare a unității de reglare, vă recomandăm să setați termosatului pe pozițiile limită cald și rece.
- Termosatul este dotat cu supape antirotur. Supapele de reținere trebuie verificate regulat conform DIN EN 1717 și standardele naționale sau regionale (anual conform DIN 1988).



Piese de schimb (vezi pag. 69)

XXX = Coduri de culori
000 = crom
090 = crom/auriu optic
820 = nichel mat



Utilizare (vezi pag. 64)



Dimensiuni (vezi pag. 65)



Certificat de testare (vezi pag. 68)



Diagrama de debit

(vezi pag. 68)



Curățare

vezi broșura alăturată

Deranjament

Prea puțină apă

Cauza

Măsuri de remediere

- Presiune de alimentare insuficientă.
- Murdărie în sita de impurități a unității de reglare.

- Verificați presiunea din conducte.
- Curățați sitele de impurități la intrarea termostatalui și în unitatea de reglare.

- Sa murdărit garnitura de sită a capătului de dus.

- Curățați garnitura sită dintre capătul dus și furtun.

Curgere încălzită, apa caldă intră în conducta de apă rece sau invers, când bateria este închisă.

- Sa murdărit / sa defectat supapa anti-retur.

- Curățați sau schimbați supapa anti-retur dacă este cazul.

Temperatura apei la ieșire nu corespunde cu temperatura reglată.

- Termostatul nu a fost reglat.
- Temperatura apei calde este prea mică

- Reglați termostatul.
- Ridicați temperatura apei calde la o temperatură între 42 °C și 65 °C.

Temperatura nu poate fi reglată.

- Unitatea de reglare a temperaturii murdar sau cu depuneri de calcar.

- Curățați sau schimbați unitatea de reglare a temperaturii dacă este cazul.

- Bateria a fost racordată incorect la prima instalare. (Instalați rece - dreapta, cald - stânga) sau roțiți cu 180°.

- Montați invers blocul de funcții (roțiți cu 180°).

Butonul de pe întrerupătorul de siguranță nu funcționează.

- Arc defect
- Butonul de apăsare este calcificat sau înfundat

- Curățați și ungeți puțin arcul și butonul sau schimbați-l dacă este cazul.

Ventilul se mișcă greu.

- Piesa superioară de blocare este deteriorată.

- Schimbați piesa superioară de blocare.

Picură din capătul de dus sau pipă.

- Murdărie sau depuneri pe scaunul de garnitură, s-a deteriorat piesa superioară de oprire.

- Curățați sau schimbați piesa superioară de oprire.



Montare vezi pag. 60



Υποδείξεις ασφαλείας

- ▷ Για να αποφύγετε τραυματισμούς κατά τη συναρμολόγηση πρέπει να φοράτε γάντια.
- ▷ Το προϊόν επιτρέπεται να χρησιμοποιείται μόνο σαν μέσο λουτρού, υγιεινής και καθαρισμού του σώματος.
- ▷ Παιδιά ή ενήλικες με μειωμένες σωματικές, δυναμικές και/ή αισθητήριες ανθεκτικές δεν επιτρέπεται να χρησιμοποιούν το προϊόν χωρίς επίσημη Άδεια υποδοχής ή επίσημα οριζόμενες ή νομαρκατικές δεν επιτρέπεται να χρησιμοποιούν σε καμία περίπτωση το προϊόν.
- ▷ Οι διαφορές της πίεσης μεταξύ της σύνδεσης κρύου και ζεστού νερού θα πρέπει να αντισταθμίζονται.

Οδηγίες συναρμολόγησης

- Η κεντρική βίδα πρέπει να τοποθετηθεί, να πιυθεί και να ελεγχθεί με βάση τους ισχύοντες κανόνες υδραυλικής τέχνης!
- Θα πρέπει να πηλυνται οι οδηγίες εγκατάστασης που ισχύουν σε κάθε κράτος.

- Πριν τη συναρμολόγηση πρέπει να εξετασarı το προϊόν για ζημιές, μεταφορές. Μετά την εγκατάσταση δεν αναγνωρίζονται ζημιές από τη μεταφορά ή επιφανεακές ζημιές.

Τεχνικά Χαρακτηριστικά

Λειτουργία πίεσης:	έως 1 MPa
Συνιστώμενη λειτουργία πίεσης:	0,1 - 0,5 MPa
Πίεση ελέγχου:	1,6 MPa
(1 MPa = 10 bar = 147 PSI)	
Θερμοκρασία ζεστού νερού:	έως 80 °C
Συνιστώμενη θερμοκρασία ζεστού νερού:	65 °C
Θερμική αντοχήμπαση:	έως 70 °C / 4 min

Περιλαμβάνει βαλβίδα αντεπιστροφής.

Το προϊόν έχει σχεδιαστεί αποκλειστικά για πόσιμο νερό.

Περιγραφή συμβόλων



Μην χρησιμοποιείτε σιλικόνη που περιέχει οξικό οξύ!

max. 42 °C
Safety Function (Λειτουργία ασφαλείας) (βλ. Σελίδα 63)

Χάρη στη λειτουργία ασφαλείας, Safety Function, είναι δυνατή η προρύθμιση της επιθυμητής μέγιστης θερμοκρασίας (T_{max} 42 °C).

Ρύθμιση (βλ. Σελίδα 62)



Αφού το πραγματοποιηθεί η συναρμολόγηση, θα πρέπει να ελεγχθεί η θερμοκρασία του στομίου εκροής του θερμοστάτη. Μια διάρθωση είναι απαραίτητη όταν η μετρούμενη στο σημείο λήψης θερμοκρασία αποκλίνει από τη ρυθμιζόμενη στο θερμοστάτη θερμοκρασία.

Συντήρηση (βλ. Σελίδα 66)



- Για να διασφαλίσετε την καλή λειτουργία της μονάδας ρύθμισης, θα πρέπει να ρυθμίσετε το θερμοστάτη από καιρού εις καιρόν σε ενεώδως ζεστό ή ενεώδως κρύο.
- Ο θερμοστάτης είναι εξοπλισμένος με μια βαλβίδα αντεπιστροφής. Οι βαλβίδες αντεπιστροφής πρέπει να ελέγχονται τακτικά ως προς τη λειτουργία τους, σύμφωνα με τις οδηγίες DIN EN 1717, σε σχέση με τους ισχύοντες εθνικούς ή τοπικούς κανόνες (το εώχιστο μια φορά το χρόνο, σύμφωνα με το πρότυπο DIN 19881).

Ανταλλακτικά (βλ. Σελίδα 69)



XXX = Χρώματα
000 = Επιχρωμωμένο
090 = Επιχρωμωμένο/οπτική χρυσοί
820 = νικά ματ

Χειρισμός (βλ. Σελίδα 64)





Διαστάσεις (βλ. Σελίδα 65)



Σήμα ελέγχου (βλ. Σελίδα 68)

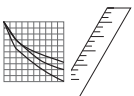

Ανίχνευση ροής

(βλ. Σελίδα 68)



Καθαρισμός

βλ. συνημμένο φυλλάδιο

ΒΑΔΒΗ

Ανεπαρκές νερό

Αρτία

- Η πίεση προχώρα δεν είναι επαρκής

Διάβρωση

- Ελέγξτε την πίεση των αγωγών αποχέυσης/ύδρευσης

- Βρώμικο φίλτρο συλλογής ακαθάρσιων της μονάδας ρύθμισης

- Καθαρίστε το φίλτρο συλλογής ακαθάρσιων προ του θερμοστάτη και επάνω στη μονάδα ρύθμισης

- Βρώμικη στεγανοποιητική σήρα του καταιονιστήρα

- Καθαρίστε και, εάν χρειαστεί, αλλάξτε τη στεγανοποιητική σήρα μετάξυ καταιονιστήρα και σπιδρά

Η σταυροειδής ροή και το ζεστό νερό ρυθμίζονται με κλειστή βάνα στον αγωγό κρύου νερού, πατώντας τη βάνα ή αντιστροφή

- Βρώμικη/εδαψιματική βαλβίδα αντιστροφής

- Καθαρίστε και, εάν χρειαστεί, αλλάξτε τη βαλβίδα αντιστροφής

Η θερμοκρασία εκροής δεν συμφώνει με τη ρυθμισμένη θερμοκρασία

- Ο θερμοστάτης δεν έχει ρυθμιστεί

- Ρυθμίστε το θερμοστάτη

Δεν είναι δυνατή η ρύθμιση της θερμοκρασίας

- Χαμηλή θερμοκρασία ζεστού νερού

- Αυξήστε τη θερμοκρασία του ζεστού νερού μετάξυ των 42°C και των 65°C

Δεν είναι δυνατή η ρύθμιση της θερμοκρασίας

- Η μονάδα ρύθμισης θερμοκρασίας είναι βρώμικη ή φέξει λάκκα

- Καθαρίστε και, εάν χρειαστεί, αλλάξτε τη μονάδα ρύθμισης θερμοκρασίας

- Σε νέα εγκατάσταση: Λάθος σύνδεση βασικού κορμού (θα πρέπει: κρύο δεξιά, ζεστό αριστερά) ή ο βασικός κορμός έχει εγκατασταθεί περιστρεφόμενο κατά 180°

- Εγκαταστήστε το σήμα λεπουργίας περιστρεφόντος το κατά 180°

- Εδαψιματικό ελατήριο ακάθαρτο

- Καθαρίστε και λιπάνετε ελαφρά, και, εάν χρειαστεί, αλλάξτε το ελατήριο ή και το πιεστικό κουμπι

Πιεστικό κουμπι ή διάταξη φραγής ασφαλείας, χωρίς λεπουργία

- Διατμηματικό ελατήριο ακάθαρτο

- Καθαρίστε και λιπάνετε ελαφρά, και, εάν χρειαστεί, αλλάξτε το ελατήριο ή και το πιεστικό κουμπι

Σκληρή βαλβίδα

- Βαλβή στο πάνω μέρος της διάταξης φραγής

- Αλλάξτε το πάνω μέρος της διάταξης φραγής

Ο καταιονιστής ή η αποχέτευση (πουξούλι) στάζουν

- Βρωμά ή καθιζήσεις στο στεγανοποιητικό φίλτρο, βαλβή στο πάνω μέρος της διάταξης φραγής

- Καθαρίστε ή/και αλλάξτε το πάνω μέρος της διάταξης φραγής



Συναρμολόγηση βλ. Σελίδα 60



Varnostna opozorila

- ▲ Pri montaži je treba nositi rokavice, da se preprečijo poškodbe zaradi zmečkanja ali urezov.
- ▲ Ta izdelek se sme uporabljati le z namenom umivanja, vzdrževanja higiene in telesne nege.
- ▲ Otroci kot tudi odrasle osebe z omejenimi telesnimi, duševnimi in/ali senzoričnimi sposobnostmi ne smejo nadzorovano uporabljati tega izdelka. Osebe, ki so pod vplivom alkohola ali drog, tega izdelka ne smejo uporabljati.

▲ Velike razlike v tlaku med priključkom za mrzlo in priključkom za toplo vodo je potrebno izravnati.

Navodila za montažo

- Armatura je potrebno montirati, sprati in testirati v skladu z veljavnimi normami
- Upoštevati je treba pravilnike o inštalacijah, ki veljajo v posamezni državi.
- Pred montažo je treba izdelek preveriti glede morebitnih transportnih poškodb. Po vgradnji transportne ali površinske poškodbe ne bodo več priznane.

Tehnični podatki

Delovni tlak:	maks. 1 MPa
Priporočeni delovni tlak:	0,1 - 0,5 MPa
Prekusni tlak:	1,6 MPa
(1 MPa = 10 bar = 147 PSI)	
Temperatura tople vode:	maks. 80 °C
Priporočena temperatura tople vode:	65 °C
Termična dezinfekcija:	maks. 70 °C / 4 min

Zaščita proti povratnemu toku

Proizvod je zasnovan izključno za sanitarno vodo!

Opis simbola



Ne smete uporabiti silikona, ki vsebuje oceno kislinol!

max. ≈ 42 °C 63) **Varnostna funkcija** • (glejte stran

Varnostna funkcija omogoča, da vnaprej nastavimo najvišjo željeno temperaturo npr. 42 °C.



Nastavitev (glejte stran 62)

Po opravljeni montaži je treba preveriti izočno temperaturo na termostatu. Če na odzvemnem mestu izmerjena temperatura odstopa od temperature, nastavljene na termostatu, je potreben popravek.



Vzdrževanje (glejte stran 66)

- Da bi zagotovili gladko delovanje enote za uravnavanje, je potrebno termostat občasno nastaviti popolnoma na toplo in popolnoma na mrzlo.
- Termostati je opremljen s protipovratnim ventilom. Delovanje protipovratnega ventila je potrebno v skladu z DIN EN 1717 in skladno z državnimi in regionalnimi določili (DIN 1988 enkrat letno) redno testirati.



Rezervni deli (glejte stran 69)

XXX = Barve
000 = krom
090 = krom/pozlačena
820 = brushed nickel



Upravljanje (glejte stran 64)



Mere (glejte stran 65)

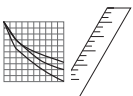

Diagram pretoka

(glejte stran 68)



Preskusni zrnk (glejte stran 68)



Čiščenje

glejte priloženi brošuri

Napaka

Malo vode

Vzrok

Pomoč

- Nezadosten oskrbovalni tlak
- Prevelike tlak v ceveh
- Filter enote za uravnavanje je umazan
- Očistite filtre pred termostatom in na enoti za uravnavanje
- Filtrirna mrežica prhe je umazana
- Očistite filtrirno mrežico med prho in globko cevijo

Križni tok, toplo vodo ob zaprti armaturi potiska v cevi mizle vode ali obratno

- Protipovratni ventil je umazan/pokvarjen
- Očistite oz. po potrebi zamenjajte protipovratni ventil

Temperatura vode pri izlivu ne ustreja temperaturi, ki ste jo nastavili.

- Termostat ni bil juštrian
- Justirajte termostat
- Prenizka temperatura tople vode
- Povišajte temperaturo tople vode na 42 °C do 65 °C

Uravnavanje temperature ni mogoče

- Enota za uravnavanje temperature je umazana ali poopnena
- Očistite oz. po potrebi zamenjajte enoto za uravnavanje temperature
- Pri novi inštalaciji je osnovni del napočno priključen (moralo bi biti: mizlo desno, toplo levo) ali vgrajen z zasúkom za 180°.
- Vgradite funkcijski blok za 180° obrnjeno

Gumb varnostne zapore ne deluje

- Pokvarjena vzmet
- Očistite in rahlo namasite oz. po potrebi zamenjajte vzmet oz. gumb
- Pritisni gumb je poopnen / umazan

Težko premikanje ventila

- Poškodovan gornji del zaporne enote
- Zamenjajte gornji del zaporne enote

Iz prha ali izliva kaplja

- Umazaniji ali usedline na sedežu ventila, gornji del zaporne enote je poškodovan
- Očistite oz. zamenjajte gornji del zaporne enote



Montaža glejte stran 60



⚠ Ohutusjuhised

- ⚠ Kandke paigaldamisel muljumis- ja löikevigastuste vältimiseks kindaid.
- ⚠ Toodet tohib kasutada ainult pesemis- hügieeni- ja kehaharustamiseseemäkitel.
- ⚠ lapsead, samuti kehaliste, vaimsete või tajupiirangu- tega töötajavahand ei tohi düsüüsteemi järelevalveks kasutada. Alkoholi või narkootikumide mõju all olevad isikud ei tohi düsüüsteemi kasutada.
- ⚠ Kui külma ja kuuma vee ühenduste surve on väga erinev, tuleb need tasakaalustada.

Paigaldamisjuhised

- Segisiti paigaldamine, loputamine ja kontroll peab toimuma vastavalt kehtivatele normidele!
- Vastavas riigis kehtivaid paigalduseeskirju tuleb järgida.
- Enne paigaldamist tuleb toodet kontrollida transport-dikahjustuste osas. Pärast paigaldamist ei tunnustata enam transporti- või pinnakahjustuste kaebuseid.

Tehnilised andmed

Töörõhk	maks. 1 MPa
Soovitatav töörõhk:	0,1 - 0,5 MPa
Kontrollsurve:	1,6 MPa
(1 MPa = 10 baari = 14,7 PSI)	
Kuuma vee temperatuur:	maks. 80 °C
Soovitatav kuuma vee temperatuur:	65 °C
Termiline desinfitseksioon:	maks. 70 °C / 4 min
Tagasivoolklapp	

Toode on ette nähtud eranditult joogivee jaoks!

Sümbolite kirjeldus



Ärge kasutage äädikhapet sisaldavat silikooni!

max. ≈ 42 °C Turvafunktsioon (vt lk 63)

Tänu ohutusfunktsioonile on võimalik soovitud maksimaaltemperatuuri eelnevalt sisestada (nt maks. 42 °C).



Reguleerimine (vt lk 62)

Paigaldamise järel tuleb kontrollida termostaadi väljundtemperatuuri. Kui väljavoolu kohas mõõdetud temperatuur erineb termostaadiga sisestatud, tuleb seda reguleerida.



Hooldus (vt lk 66)

- Termostaadi hea toimimise tagamiseks on tarvis termostaati keerata aeg-ajalt päris kuuma ja päris külma pedele.
- Termostaat on varustatud tagasilöögiklap- pidega. Tagasilöögiklappide toimimist tuleb koostöös riiklike ja regionaalsete määrustega regulaarselt kontrollida vastavalt standardile DIN EN 1717 (DIN 1988 - kard aastas).



Varuosad (vt lk 69)

XXX = Värvid
000 = kroon
090 = kroon/kuld optik
820 = brushed nickel



Kasutamine (vt lk 64)

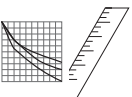

Mõõtmise (vt lk 65)

Läbivooludiagramm
(vt lk 68)



Kontrollsertifikaat (vt lk 68)



Puhastamine

vt kaasasolevast brošüürist

Rike

Vähe vett

Põhjus

- Surve ebapiisav

Lahendus

- Kontrollige vee survet torudes (kui pump on installeeritud, kontrollige kas pump töötab)

- Regulaatori filter on märdunud

- Puhastage termostaadi ees ja regulaatori peal olevad filtrid

- Duši söelühend must

- Puhastage duši ja vooliku vaheline söelühend

Ristvool, soe vesi surutakse suletud segisti korral külmaveetoru või vastupidu, kui segisti on suletud

- Tagasilöögiklapp märdunud/katki

- Tagasilöögiklapp puhastada ja vajadusel välja vahetada

Väljavoolava vee temperatuur ei vasta seadud temperatuurile

- Termostaati pole reguleeritud

- Reguleerige termostaati

- Sooja vee temperatuur liiga madal

- Tõstke sooja vee temperatuuri 42 °C kuni 65 °C

Termoregulaator pole võimalik

- Termoregulaator märdunud või lubjunud

- Termoregulaator puhastada või vajadusel välja vahetada

- Uuel paigaldusel põhikorpus valesti ühendatud (peab olema külm paremal, soe vasakul) või 180° pööratud

- Paigaldage funktsiooniblokk 180° pöördega

Ohutusnupp ei tööta

- Vedru on vigastatud või veeaga

- Puhastage ning määrige kergelt vedru või nuppu, vajadusel vahetage ära

Klapp käib raskelt

- Sulguri ülaosa on kahjustunud

- Vahetage ära sulguri ülaosa

Dušipihusti või väljavool lekib

- Thendli on mustust või setet; sulgurk-lapi ülaosa kahjustunud

- Puhastage või vahetage välja sulguri ülaosa



Paigaldamine vt lk 60



Drošības norādes

- ▶ Montāžas laikā, lai izvairītos no saspiedumiem un iegrīzumiem, nepieciešams nēsāt cimdus.
 - ▶ Šo produktu drīkst izmantot tikai, lai mazgātos, higiēnai un ķermeņa tīrīšanai.
 - ▶ Bērni, kā arī pleaugušie ar fiziskiem, garīgiem un / vai sensoriskiem ierobežojumiem nedrīkst lietot šo produktu bez uzraudzības. Personas, kas atrodas alkohola vai narkotisko vielu iespaidā, nedrīkst lietot šo dušas sistēmu.
 - ▶ Jāizliedzina spiediena atšķirības starp aukstā un karstā ūdens pievadim.
- ## Norādījumi montāžai
- Armatūra jāuzstāda, jāizskalo un jāpārbauda atbilstoši spēkā esošajām normām!
 - Jāievēro attiecīgās valsts spēkā esošās montāžas prasības.
 - Pirms montāžas nepieciešams pārbaudīt, vai produktam transportēšanas laikā nav radušies bojājumi. Pēc iebūvēšanas bojājumi, kas radušies transportēšanas laikā, vai virsmas bojājumi netiek atzīti.

Tehniskie dati

Darba spiediens:	maks. 1 MPa
Ieteicamais darba spiediens:	0,1 - 0,5 MPa
Pārbaudes spiediens:	1,6 MPa
(1 MPa = 10 bar = 147 PSI)	
Karstā ūdens temperatūra:	maks. 80 °C
Ieteicamā karstā ūdens temperatūra:	65 °C
Termiskā dezinfekcija :	maks. 70 °C / 4 min
Drošības vārstis	

Izstrādājums ir paredzēts tikai dzertamajam ūdenim!

Simbolu nozīme



Neizmantojiet silikonu, kas satur etiķskābi!

max. $\approx 42^{\circ}\text{C}$ Drošības funkcija (skat. lpp. 63)

Pateicoties drošības funkcijai, vēlamo augstāko temperatūru, piem., maks. 42° C, var iestatīt jau ierīkēs.



Ieregulēšana (skat. lpp. 62)

Pēc montāžas jāpārbauda termostato izteikta temperatūra. Korektūra ir nepieciešama gadījumā, ja temperatūra izteikas vietā atšķiras no termostatā iestatītās temperatūras.



Apkope (skat. lpp. 66)

- Lai nodrošinātu regulatora nevainojamu darbību, termostatu laiku pa laikam jāiesista uz maksimāli aukstu un maksimāli karstu ūdeni.
- Termostats ir aprīkots ar pretvārstu. Regulāri jāpārbauda pretvārsta funkcija saskaņā ar DIN EN 1717 saistībā ar nacionālajiem vai vietējiem noteikumiem (DIN 1988 vienreiz gadā).



Rezerves daļas (skat. lpp. 69)

XXX = Krāsu kodi
000 = hroma
090 = hroma/zelta
820 = brushed nickel



Lietošana (skat. lpp. 64)



Izmērus (skat. lpp. 65)

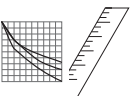

Caurplūdes diagramma

(skat. lpp. 68)



Pārbaudes zīme (skat. lpp. 68)



Trīrīšana

skatiet pievienotajā brošūrā

Traucējums

Maz ūdens

Iemesls

- Problēmas ar ūdens apgādi
- Neīters regulatora filtrs

Bojājumu novēršana

- Pārbaudīt spiedienu ūdenvadā
- Trīrīt filtrus pirms termostata un uz regulatora

- Neīters dušas filtra bīvējums

- Iztrīrīt filtra bīvējumu starp dušu un šļūteni

Ūdens sjaucukšānās, karstais ūdens slēgtā stāvoklī tiek spiests aukstā ūdens caurplūvdos un otrādi.

- Preītvārsts ir neīters / bojāts

- Trīrīt, nepieciešamības gad. nomaiņī preītvārstu

Ūdens temperatūra nesaskan ar iestatīto temperatūru

- Termostats nav pīreguleīts

- Pīreguleīr termostatu

- Pārāk zema ūdens temperatūra

- Paaugstīnāt karstā ūdens temperatūru no 42 °C līdz 65 °C

Nav iespējama temperatūras regulāšana

- Termoregulators ir aizkalķojies vai neīters

- Iztrīrīt filtra bīvējuma gad. nomaiņī termoregulatoru

- Jaunas instalācijas gadījumā pamat- elements ir nepareīzi pieslēgts (īābūt: aukstais ūdens pa labi, karstais pa kreīsl) vai ir pārgriezts par 180°.

- Pagriezt par 180° īekšājo bloku

Nestrādā sarkana poga, kas pasargā pret apdedzināšanos

- Bojāta dispere
- Poga aizkalķojies / aizsērēīusi

- Iztrīrīt un īeīlloīt, ja nepieciešams, nomaiņī atspereī vai pogu

Ventīlis ir nekustīgs

- Bojāta noslēdzēīvienība

- Nomaiņī noslēdzēīvienību

Dūša vai izteka pīl

- Neītrīrumī vai nogulsnes uz bīlvīrsmas, bojāta noslēdzēīvienība
- Noītrīrīt vai nomaiņī noslēdzēīvienību



Montāža skat. lpp. 60



Sigurnosne napomene

- ▶ Prilikom montaže se radi sprečavanja prignječenja i posekoina moraju nositi rukavice.
- ▶ Proizvod sme da se koristi samo za kupanje, tuširanje i ličnu higijenu.
- ▶ Deca, kao i telesno, mentalno i/ili senzorno hendikepirane odrasle osobe ne smeju da koriste proizvod bez nadzora. Osobe koje su pod uticajem alkohola ili droga ne smeju da koriste proizvod.
- ▶ Velika razlika u pritisku između vruće i hladne vode mora biti izbalansirana.

Instrukcije za montažu

- Armatura mora biti postavljena, ispravna i testirana prema važećim normama!
- Treba se pridržavati propisa koji u određenim zemljama važe za instalacije.
- Pre montaže se mora proveriti da li je proizvod oštećen pri transportu. Nakon ugradnje se ne priznaju nikakve reklamacije koje se odnose na površinska i transportna oštećenja.

Tehnički podaci

Radni pritisak:	maks. 1 MPa
Preporučeni radni pritisak:	0,1 - 0,5 MPa
Probni pritisak:	1,6 MPa
(1 MPa = 10 bar = 147 PSI)	
Temperatura vruće vode:	maks. 80 °C
Preporučena temperatura vruće vode:	65 °C
Termička dezinfekcija:	maks. 70 °C / 4 min

Zaštita od povratnog toka

Proizvod je koncipiran isključivo za pijaću vodu!

Opis simbola



Nemojte koristiti silikon koji sadrži sircetnu kiselinu!

max. $\approx 42^{\circ}\text{C}$
Safety funkcija (vidi stranu 63)

Zahvaljujuću Safety funkciji, može se podesiti željena maksimalna temperatura, npr. maks. 42 °C.



Podšavanje (vidi stranu 62)

Nakon instalacije potrebno je ispitati izlaznu temperaturu termostata. Korekcija je neophodna, ako izmerena temperatura odstupa od temperature koja je nameštena na termostatu.



Održavanje (vidi stranu 66)

- Kako bi se olakšala prohodnost i produžila vek trajanja regulacione jedinice, potrebno je s vremena na vreme podesiti termostat na položajne za maksimalno toplu i maksimalno hladnu vodu.
- Termostat je opremljen nepovratnim ventilom. Ispravno funkcionisanje nepovratnog ventila se mora redovno proveravati prema standardu DIN EN 1717 i u skladu s važećim nacionalnim ili regionalnim propisima (DIN 1988 jednom godišnje).



Rezervni delovi (vidi stranu 69)

XXX = Oznake boja
000 = hrom
090 = dezen hrom/zlatna
820 = brushed nickel



Rukovanje (vidi stranu 64)



Mere (vidi stranu 65)

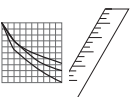

Dijagram protoka

(vidi stranu 68)



Ispitni znak (vidi stranu 68)



Čišćenje

vidi priloženoj brošuri

Smetnja

Nedovoljno vode

Uzrok

- Prenizak pritisak vode

Pomoć

- Ispitajte pritisak u cevima

- Očistite mrežicu za hvatanje
priljavštine regulacione jedinice

- Očistite mrežice za hvatanje
priljavštine ispred termostata i na
regulacionoj jedinici

- Mrežasta zaprtivka tuša je prljava

- Očistite mrežastu zaprtivku između
tuša i crijeva

Ukšteni tok vode, kod zatvorene
armature vruća voda ulazi u cev s
hladnom vodom i obrnuto

- Nepovratni ventil je prljav /
neispravan

- Očistite ili, po potrebi, zamenite
nepovratni ventil

Temperatura na slavini se
ne podudara s podešenom
temperaturom

- Termostat nije podešen
- Preniska temperatura tople vode

- Podestite termostat
- Povećajte temperaturu vruće vode
na 42-65 °C

Regulisanje temperature nije moguće

- Regulator temperature je prljav ili
obložan naslagama kamenca

- Očistite ili zamenite regulator
temperature.

- Pri ponovnoj instalaciji telo je
pogrešno priključeno (potrebno je
priključiti hladnu vodu desno, a vruću
levo) ili je zakrenuto za 180 stepeni.

- Unutrašnji blok okrenite za 180
stepeni

Dugme sigurnosnog prekida je van
funkcije

- Opruga je neispravna
- Dugme je zacepljeno slojem kamenca
ili prljava

- Očistite i podmažite oprugu, tj.
dugme, u slučaju potrebe dugme
možete zameniti novim

Ventil je neprohodan

- Gornji deo ventila za zatvaranje je
oštećen

- Zamenite gornji deo ventila za
zatvaranje

Tuš ili slavina kaplje

- Priljavština ili naslage kamenca na
ventilima, gornji deo ventila za
zatvaranje je oštećen

- Očistite, tj. zamenite gornji deo
ventila za zatvaranje



Montaža vidi stranu 60



Sikkerhetshenvisninger

- ▶ Bruk hansker under montasjonen for å unngå klem- og kuttskader.
- ▶ Dusjsystemet skal kun brukes for bade-, hygiene- og kroppshygiene.
- ▶ Barn og voksne med fysiske og psykiske og/eller sensoriske handikap skal ikke bruke dusjsystemet uten oppsyn. Personer som er påvirket av alkohol eller narkotika skal ikke bruke dusjsystemet.
- ▶ Store trykkdifferanser mellom kaldt- og varmtvannstilkoblinger skal unngås.

Montagehenvisninger

- Armaturen skal monteres iht. gyldige standarder. De skal spyles og sjekkes!
- Gjeldende retningslinjer for rørleggerarbeid i de enkelte land skal følges.
- Før montasen skal produktet sjekkes for transportskader. Etter monteringen aksepteres ikke noen transport- eller overflateskader.

Tekniske data

Driftstrykk	maks. 1 MPa
Anbefalt driftstrykk:	0,1 - 0,5 MPa
Prøvetrykk	1,6 MPa
(1 MPa = 10 bar = 147 PSI)	
Varmtvannstemperatur	maks. 80 °C
Anbefalt temperatur for varmt vann	65 °C
Termisk desinfisering:	maks. 70 °C / 4 min

Egenskter mot tilbakeflyt

Produktet er utelukkende designet for drikkevann!

Symbolbeskrivelse



Ikke bruk silikon som inneholder eddiksyre!

max. ≈ 42 °C
Safety Function (se side 63)

Takket være egenskapen "Safety Function" kan det forhåndsinnstilles en ønsket maks. temperatur, f.eks. 42 °C.



Justering (se side 62)

Etter avsluttet montering skal termostatens utløpstemperatur kontrolleres. Det er nødvendig med korrektur når temperaturen målt ved uttaksstedet avviker fra temperaturen som er innstilt på termostaten.



Vedlikehold (se side 66)

- For å holde regulerings-enheten bevegelig, skal termostaten stilles fra tid til annen på helt varmt og helt kaldt.
- Termostaten er utstyrt med returløps-spørre. Funksjonen til returløpsspørren skal iht. DIN EN 1717 og i samsvar med de nasjonale og lokale forskrifter sjekkes regelmessig (DIN 1988 en gang i året).



Serviceledet (se side 69)

XXX = Forgekode
000 = krom
090 = krom/gull-optikk
820 = børstet nikkel



Betjening (se side 64)



Mål (se side 65)



Prøvemærke (se side 68)

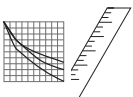

Gjennomstrømningsdiagram

(se side 68)



Rengjøring

se vedlagt brosjyre

Feil

	Årsak	Feilrettelse
<p>Lite vann</p>	<ul style="list-style-type: none"> - Forsyningstrykk er ikke tilstrekkelig - Smussfangersil til reguleringsenheten skitten. - Dusjens silpakkning er skitten 	<ul style="list-style-type: none"> - Ledningstrykk sjekkes - Smussfangersil før termostaten og på reguleringsenheten rengjøres - Silpakkning mellom dusj og slangen rengjøres
<p>Kryssstrøming, varmt vann presseses ved lukket armatur inn i kaldtvannsledning eller omvendt</p>	<ul style="list-style-type: none"> - Returløpstopper skitten / defekt 	<ul style="list-style-type: none"> - Returløpstopper rengjøres, byttes hvis nødvendig
<p>Utløpstemperatur samsvarer ikke med innstilt temperatur</p>	<ul style="list-style-type: none"> - Termostat ble ikke justert - For lav varmvannstemperatur 	<ul style="list-style-type: none"> - Termostat justeres - Varmtvannstemperatur økes til mellom 42 °C og 65 °C
<p>Temperaturregulering er ikke mulig</p>	<ul style="list-style-type: none"> - Reguleringsenhet for temperatur er skitten eller forkalket - Ved nyinstallasjon: basisselement feilaktig tilkoblet (riktig: kaldt høyre, varmt venstre) eller bygd inn 180° forvrent 	<ul style="list-style-type: none"> - Reguleringsenhet for temperatur rengjøres og byttes hvis nødvendig - Funksjonsblokk bygges inn 180° forvrent
<p>Trykknapp til sikkerhetsperren uten funksjon</p>	<ul style="list-style-type: none"> - Fær defekt - Trykknapp forkalket/ forurenset 	<ul style="list-style-type: none"> - Fær hv. Trykknapp rengjøres og smøres lett inn, byttes hvis nødvendig
<p>Ventil er ikke lett bevegelig</p>	<ul style="list-style-type: none"> - Avsperrings-overdel skadet 	<ul style="list-style-type: none"> - Bytte avsperrings-overdel
<p>Dusj eller utløp drypper</p>	<ul style="list-style-type: none"> - Smuss eller avleiringer på teiningen, avsperrings-overdel skadet 	<ul style="list-style-type: none"> - Avsperrings-overdel rengjøres hv. byttes



Montasje se side 60



Указания за безопасност

- При монтажа трябва да се носят ръкавици, за да се избегнат норманявния породи приликсакне или порязване.
- Позволено е използването на продукта само за къпане, хигиена и цели на почистване на тялото.
- Не е позволено деца, както и възрастни с физически, умствени и / или сензорни ограничения да използват продукта без надзор. Не е позволено използването на системата на продукта от лица, употребили алкохол или дрога.
- Големите разлики в налягането между изводите за студентата и топлата вода трябва да се изравняват.

Указания за монтаж

- Арматурата трябва да се монтира, промие и провери в съответствие с валидните норми!
- Трябва да бъдат спазвани валидните в съответните страни предписания за инсталлиране.
- Преди монтажа продуктът трябва да се провери за транспортни щети. След монтажа не се признават транспортни или повърхностни щети.

Технически данни

Работно налягане:	макс. 1 МПа
Препоръчително работно налягане:	0,1 - 0,5 МПа
Контролно налягане:	1,6 МПа
(1 МПа = 10 bar = 147 PSI)	
Температура на горещата вода:	макс. 80 °С
Препоръчителна температура на горещата вода:	65 °С
Термична дезинфекция:	макс. 70 °С / 4 мин

Самозащитен против обратен изтичане

Продуктът е разработен само за питейна вода!

Описание на символите



Не използвайте силкон, съдържащ оцветители на киелини!

max. $\approx 42^{\circ}\text{C}$
Safety Function (Функция за безопасност) (вижте стр. 63)

Благотворение на Safety Function (функция за безопасност) желаната максимална температура може да се настрои предвагително напр. на макс. 42 °С.



Юстиране (вижте стр. 62)

След извършен монтаж трябва да се провери температурата на крайника на термостата. Ако измерената температура на мястото на водоземане се различава от настроената на термостата температура, е необходима корекция.



Поддръжка (вижте стр. 66)

• За да се гарантира лекоподвижността на регулиращото звено, от време на време термостатът трябва да се поставя на максимално топло и на максимално студено.

• Термостатът е оборудван с предпазител за обратен поток. Съгласно DIN EN 1717 редовно трябва да се проверява функционирането на приспособленията за предотвратяване на обратния поток в съответствие с националните или регионални изисквания (DIN 1988 веднъж годишно).



Сервизни части (вижте стр. 69)

XXX = Цветово кодиране
000 = хром
090 = хром/оптика за злато
820 = надраскан никел

Обслужване (вижте стр. 64)





Размери (вижте стр. 65)

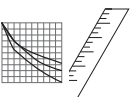

Диаграма на потока

(вижте стр. 68)



Контролен знак (вижте стр. 68)



Почистване

от приложената брошура

Неизправност

Причина

Помощ

Малко вода

- Захранващото налягане не е достатъчно

- Проверете налягането на тръбопровода

- Цедката за улавяне на замърсяванията на регулиращия елемент е замърсена

- Почистете цедките за улавяне на замърсяванията преди термостата и на регулиращия елемент

- Замърсено е уплътнението с цедка на разпръсквателя

- Почистете уплътнението с цедка между разпръсквателя и мръкуча

Кръгосване на потока, при загрявена арматура топлата вода навлиза в линията на студения вода или обратно

- Замърсено / дефектно приспособление за предотвратяване на обратния поток

- Почистете респ. сменете приспособлението за предотвратяване на обратния поток

Изходящата температура не съвпада с настроената температура

- Термостатът не е остриран
- Твърде ниска температура на водата

- Остриране на термостата
- Повишете опреничението за топлата вода на 42 °C до 65 °C

Не е възможно регулиране на температурата

- Припособлението за регулиране на температурата е замърсено или покрито с варовик

- Почистете респ. сменете приспособлението за регулиране на температурата

- При нова инсталация основното тяло е свързано погрешно (Зад.: студено отдясно, топло отляво или монтирайте със завъртане от 180°

- Монтирайте функционалния блок със завъртане на 180°

Копчето на предпозната блокировка не функционира

- Дефектна пружинка
- Копчето е покрито с варовик / замърсено

- Почистете пружината респ. копчето и ги смажете леко, при необх. ги сменете

Трудно подвижен клапан

- Повредена горна част на блок-роеквата

- Смяна на горната част на блок-роеквата

Разпръсквателът или изходящият накрайник капел

- Мръсотия или отлагания на уплътняващата повърхност, повредена горна част на блокировката

- Почистете респ. сменете горната част на блокировката



Монтаж вижте стр. 60



Udhëzime sigurie

- ▶ Për të evituar lëndimet e pickimeve ose të prerjeve gjatë procesit të montimit duhet që të vishni dorëza.
 - ▶ Produkti duhet të përdoret vetëm qëllimët e bërta dhe të higjienës dhe të larjes së trupit.
 - ▶ Fëmijët dhe të rriturit me afësi të kufizuara fizike, mendore dhe/ose ndijëse nuk duhet ta përdorin produktin pa qenë nën mbikëqyrje. Përsnat që janë nën ndikimin e drogave ose të alkoolit nuk duhet ta përdorin produktin.
 - ▶ Ndryshimet e mëdha të presionit mes lidhjeve të ujit të ftohtë dhe atij të ngrohtë duhen ekulibruar.
- ### Udhëzime për montimin
- Armatura duhet montuar, shpërndarë dhe kontrolluar në bazë të normave të vlefshme!
 - Duhet të respektohen linjat udhëzuese të instalimit, të vlefshme për vendet respektive.
 - Përpara montimit duhet që produkti të kontrollohet për dëmtime nga transporti. Pas instalimit nuk do të njihet asnjë dëmtim nga transporti ose dëmtim i sipërfaqes.

Të dhëna teknike

Presioni gjatë punës	maks. 1 MPa
Presioni i rekomanduar:	0,1 - 0,5 MPa
Presioni për provë:	1,6 MPa
(1 MPa = 10 bar = 147 PSI)	
Temperatura e ujit të ngrohtë	maks. 80 °C
Temperatura e rekomanduar e ujit të ngrohtë:	65 °C
Dëzinfektim Termik:	maks. 70 °C / 4 min

Siguresa kundër rrijedhies në drejtim të kundërt

Produkti është projektuar ekskluzivisht për ujë të pijshëm!

Përshkrimi i simbolit



Mos përdorni silikon që në përbërje ka acid acetik.

max. ≈ 42 °C **63)** **Funksionet e sigurisë** (shih faqen

Falë Safety Function mund të përcaktohet temperatura maksimale e dëshinuar, p.sh. 42 °C.



Justimi (shih faqen 62)

Pas montimit duhet kontrolluar temperatura në dalje e termostatit. Korrigjimet janë të nevojshme, nëse temperatura e matur në pikën e rrijedhies së ujit nuk është e njëjtë me temperaturatën e përcaktuar në termostat.



Mirëmbajtja (shih faqen 66)

- Për të lehtësuar përdorimin e njësisë rregulluese, termostati do të dhuhet çfar herë pas here nga shumë i ngrohtë në shumë të ftohtë.

- Termostati është i pajisur me pengues të rrijedhies në drejtim të kundërt. Penguesit e rrijedhies në drejtim të kundërt duhen kontrolluar rregullisht në bazë të normave DIN EN 1717 konform normave nacionale dhe regjionale (DIN 1988 një herë në vit).



Pjesët e servisit (shih faqen 69)

XXX = Kodimi me anë të ngjyrave
000 = krom
090 = krom/i arte-optike
820 = nikeli i furçuar

Përdorimi (shih faqen 64)





Përmaset (shih faqen 65)



Shenja e kontrollit (shih faqen 68)

Diagrami i qarkullimit

(shih faqen 68)



Pastrimi

shikoni broshurën bashkëngjitur

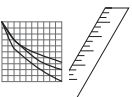

Demtim

Shkaku

Ndihme

Pak ujië

- | | |
|--|---|
| - Presioni ushqyes jo limitivueshem | - Kontrolloni presionin e tubacionit |
| - Sita qe mbledh papasteritë tek njesia rregulluese eshte me papasteri | - Pastroni siten para termostatit dhe mbi njesine rregulluese |
| - Gominat hermetizuese e pajisjes me papasteri | - Pastroni gominen e sites midis pajisjes dhe tubit |

Rriedhje e kryqezuor, uji i ngrrohte do te cohet tek tubacioni i ujit te ftohte kur armatura eshte e mbyllur ose anastelltas

- | | |
|---|---|
| - Penguesi i rriedhjes mbrapsht te ujit me papasteri ose me defekti | - Pastroni ose kembeni penguesim e rriedhjes mbrapsht te ujit |
|---|---|

Temperatura reade nuk perputhet me temperaturën e regjistruar

- | | |
|---|---|
| - Termostati nuk eshte rregulluar | - Rregulloni termostatin |
| - Temperaturë e ujit e ujit të ngrrohtë | - Krisni temperaturën e ujit te ngrrohte nga 42 °C deri 65 °C |

Rregullimi i temperaturës nuk eshte i mundur

- | | |
|--|--|
| - Njesia rregulluese e temperaturës me papasteri ose me kalk | - Pastroni ose kembeni njesine rregulluese te temperaturës |
| - Tek instalimi i ri karkasa baze eshte lidhur gabim(Duhet: ftohte djathtas, ngrrohte majtas) ose eshte montuar 180grade ndryshe | - Montoni bllokun e funksioneve ne 180 grade mbrapsht |

Butoni i bllokuesit te sigurise pa funksion

- | | |
|--------------------|--|
| - Susta me defekti | - Pastroni butonin ose susten dhe grastrocileni pak, ose nderrojeni është bllokuar |
|--------------------|--|

Ventili punon rende

- | | |
|--|---|
| - Pjesa e sipërme e bllokuesit e demtuar | - Ndërroni pjesën e sipërme te bllokuesit |
|--|---|

Pajisja ose shkarkimi pikon

- | | |
|--|---|
| - Papasteri ose depozilime mbi hermetizuesit, pjesa e sipërme e bllokuesit e demtuar | - Pastroni ose kembeni pjesën e sipërme te bllokuesit |
|--|---|



Montimi shih faqen 60



شهادة اختيار (راجع صفحة 68)



التنظيف

راجع والكتيب الرفق

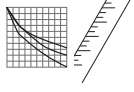

أبعاد (راجع صفحة 65)

رسم للمصرف
(راجع صفحة 68)

العلاج والإصلاح

السبب

العطل

- افحص ضغط الواسير	- ضغط الإمداد ليس كافياً	- الماء غير كافٍ
- نظف مرشحات الانساخت إلى الترموستات والنظم	- مرشح الانساخت الخاص بالنظم متسخ	
- نظف سحادة المصفاة بين الدش والخرطوم	- سحادة مصفأة الدش متسخة	
- قم بتنظيف صمام منع الرجوع أو تغييره إذا لزم الأمر	- صمام منع الرجوع متسخ / تالف	- تدفق منعكس للمياه الماء الساخن يندفع في ماسورة البارد أو العكس والخلاط مغلق.
- اضبط الترموستات	- لم يتم ضبط الترموستات	- حرارة المياه لا تتوافق مع درجة الحرارة المضبوطة
- ارفع حد الماء الساخن إلى 42° - 65° درجة مئوية	- درجة حرارة الماء الساخن منخفضة للغاية	
- قم بتنظيف منظم الحرارة أو تغييره إذا لزم الأمر	- منظم الحرارة متسخ أو عليه جبر	- تنظيم الحرارة غير ممكن
- قم بترييب الكنتاكة بالعكس 180 درجة	- تم ترييب الجزء الرئيسي من الخلاط بشكل خاطيء (يتبعي أن يكون البارد جيلاً. والساخن يساراً) أو تم عكسه 180 درجة	
- قم بتنظيف اليان زر المضط مع تشحيمهما بشكل خفيف، أو قم بتغييرهما إذا لزم الأمر	- زر الضغط به جبر / متسخ	- زر الضغط الخاص يقفل الأمان لا يعمل
- تغيير جزء الغلق العلوي	- جزء الغلق العلوي تالف	- الصمام يقبل الحركة
- تنظيف أو تغيير جزء الغلق العلوي	- انساخت أو ترسبات على جزء الإحكام، جزء الغلق العلوي تالف	- تساقط قطرات مياه من الدش أو الخلاط





وصف الرموز

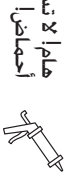

هام! لا تستخدم السليكون الذي يحتوي على أحماضاً

وظيفة الأمان (راجع صفحة 63)

يجب إجراء ضغط مسبق للحد الأقصى لدرجة الحرارة المزعومة. على سبيل المثال بحد أقصى 42° بفضل وظيفة الأمان.

الضغط (راجع صفحة 62)



بعد التركيب يجب فحص درجة حرارة الترموستات. يلزم إجراء تصحيح إذا اختلفت درجة الحرارة المقاسة عند موقع القياس عن درجة حرارة الترموستات.

⚠ تنبيهات الأمان

- ⚠ يجب ارتداء قفازات للحد أثناء التركيب لتجنب حدوث أخطار الإنحنسار أو الجروح.
- ⚠ لا يجب استخدام نظام الدش، إلا في أعراض الاستخدام والأعراض الصحية وأعراض تنظيف الجسم.
- ⚠ لا يسمح لأي أطفال أو أفراد بالغين يعانون من إعاقات بدنية أو ذهنية أو حسية أو يعانون من جميع هذه الإعاقات باستخدام المنتج إلا تحت إشراف آخرين. كما أنه لا يسمح لأي شخص تحت تأثير تناول الكحول أو المخدرات باستخدام نظام الدش.

⚠ يجب أن يكون تيار الماء الساخن والماء البارد متعادلين في الضغط.

تعليمات التركيب

- يجب تركيب الوصلة، وغمرها بالماء واختبارها وفقاً للمعايير السابقة
- يجب مراعاة القواعد الخاصة بالتركيب وأعمال السباكة وفقاً للوائح الخاصة بكل بلد.

- قبل القيام بعملية التركيب، يجب فحص المنتج للتأكد من خلوه من أية تلفيات ناتجة عن النقل. بعد القيام بعملية التركيب، لن يتم الاعتراف بوجود أية تلفيات سطحية أو تلفيات ناتجة عن عملية النقل.

المواصفات الفنية

- ضغط التشغيل: الحد الأقصى 1 ميجاباسكال
- ضغط الاختبار الموصى به: 0,1 - 0,5 ميجاباسكال
- صنف الاختبار: 1 ميجاباسكال
- (1 ميجاباسكال = 10 بار = 147 PSI)
- درجة حرارة الماء الساخن: الحد الأقصى 80° C
- درجة الحرارة الموصى بها للماء الساخن: 65° C
- تعقيم حراري: الحد الأقصى 70° C / 4 الدقيقة

خاصية عدم التحقق العكسي

المنتج مخصص فقط للماء الشرب!



قطع الغيار (راجع صفحة 69)

- XXX = الألوان
- 000 = كروم
- 090 = كروم / لون ذهبي
- 820 = نيكل مُفْرِش



التشغيل (راجع صفحة 64)

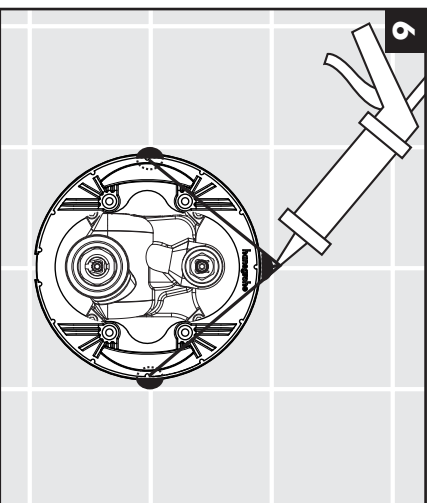
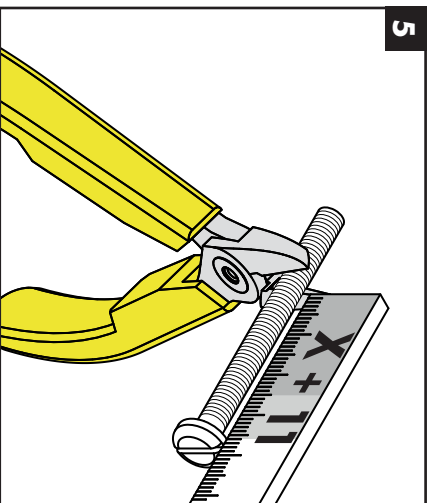
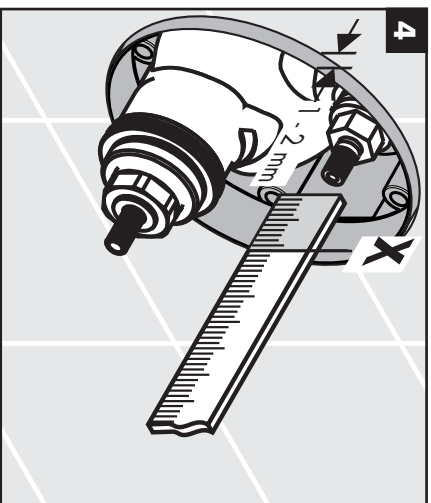
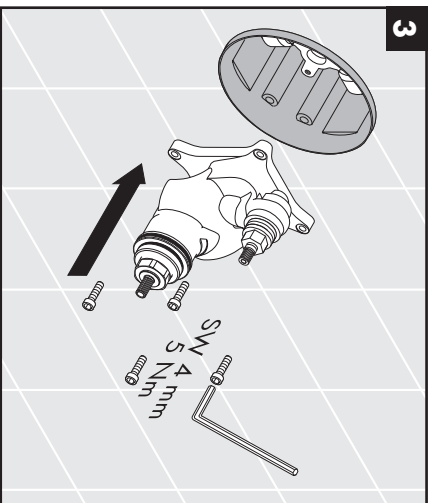
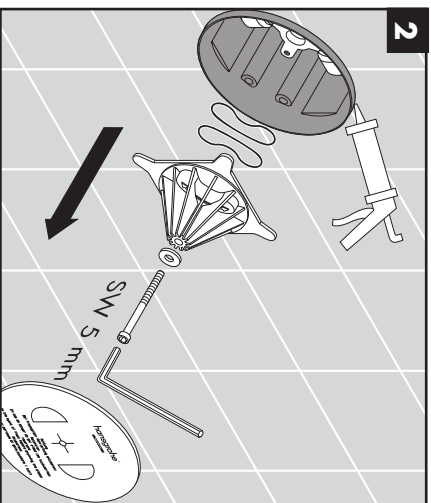
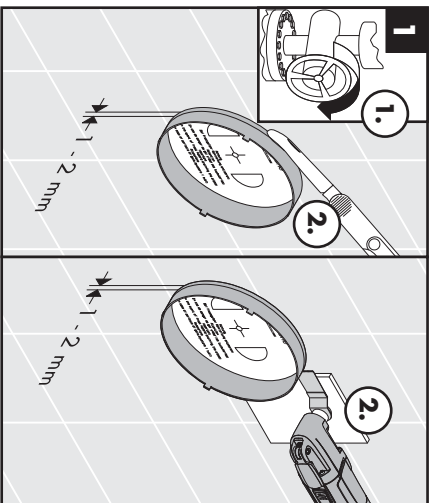

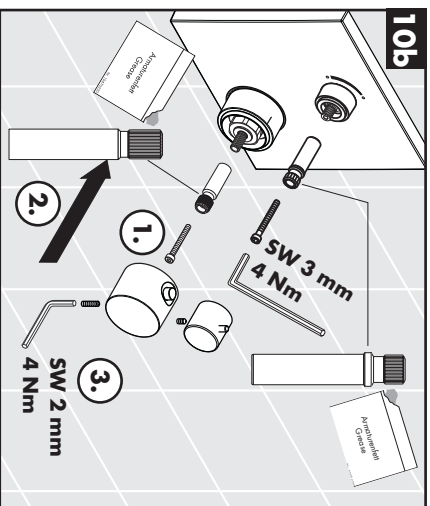
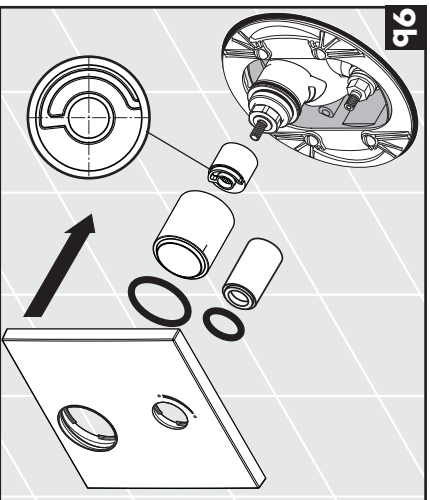
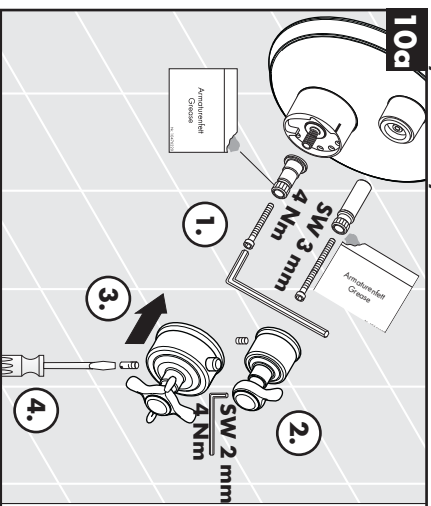
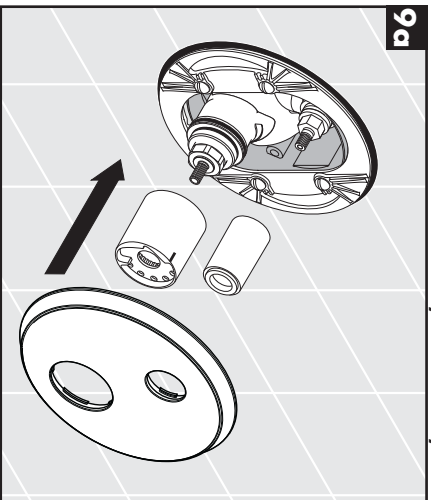
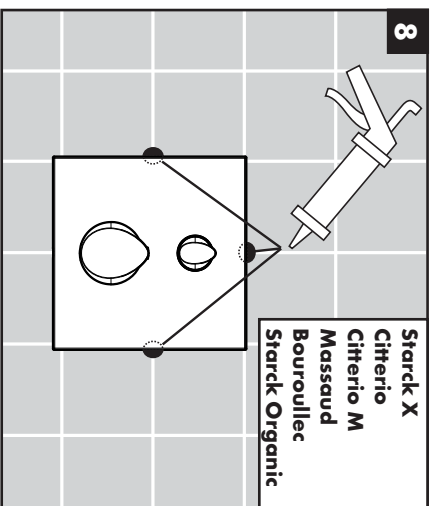
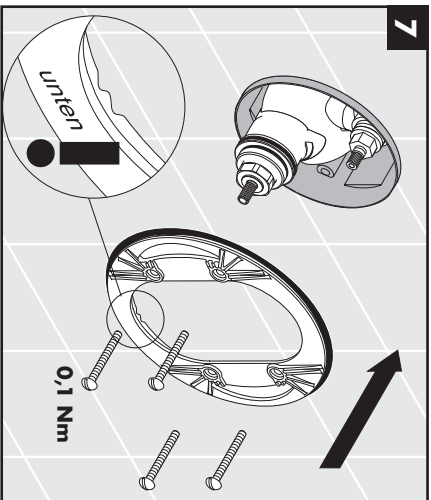



Stark Organic / Citteriom / Uno

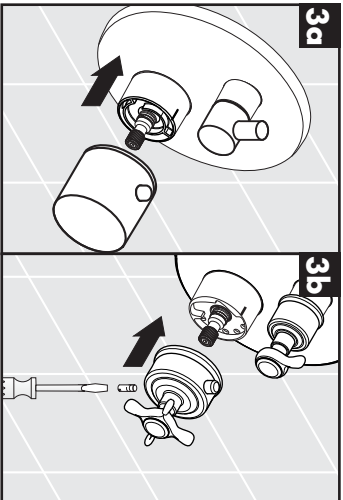
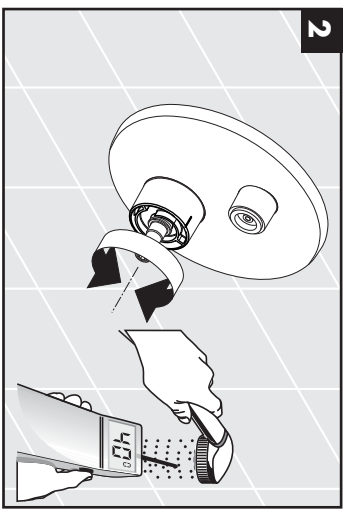
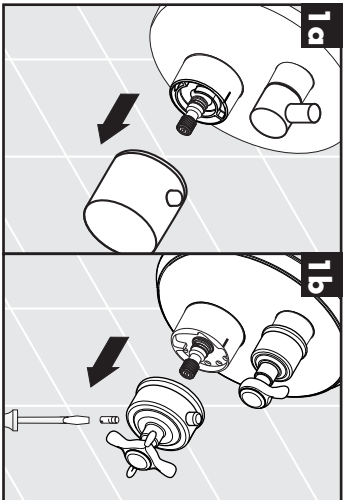
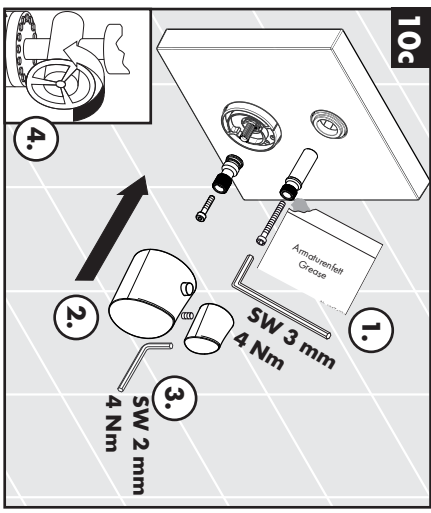
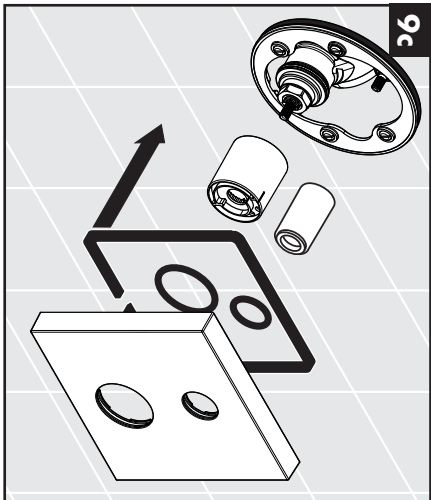

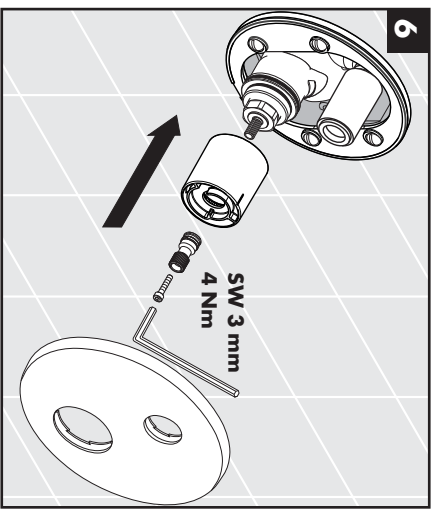
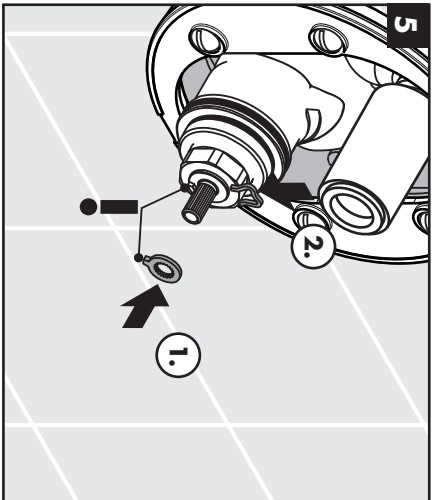
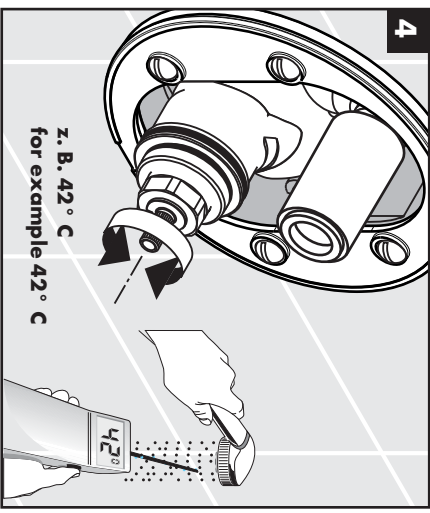
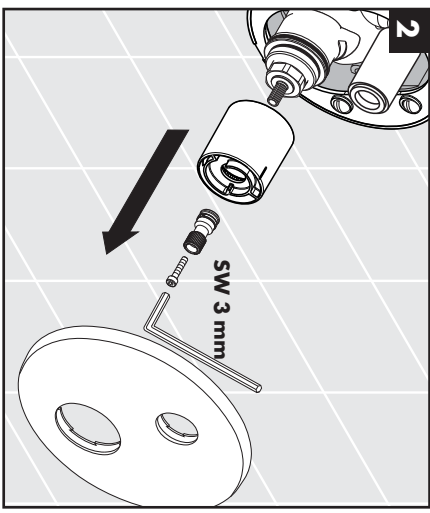
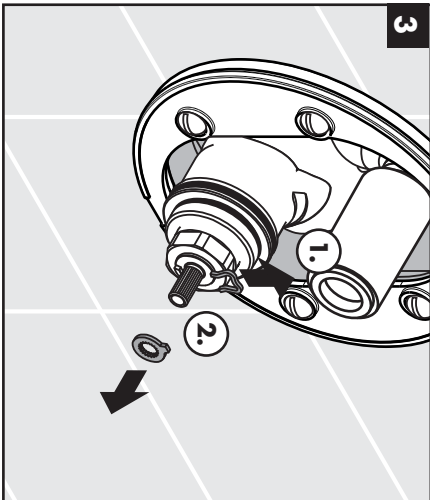
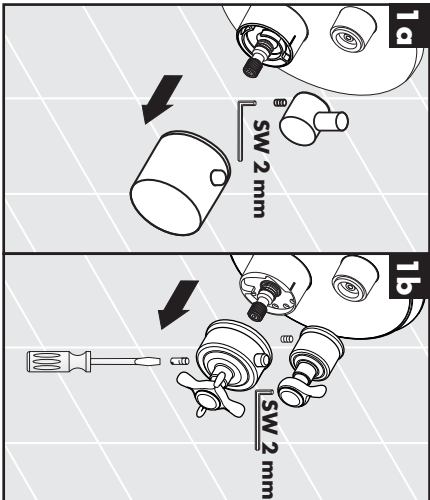

max.
≈ 42 °C

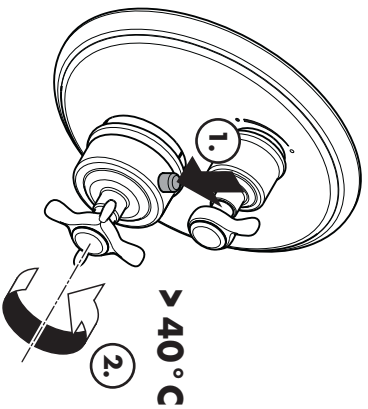
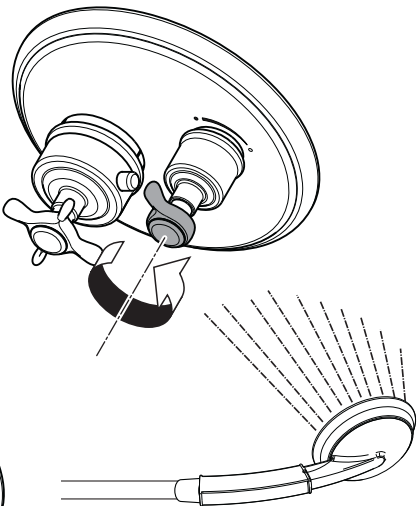
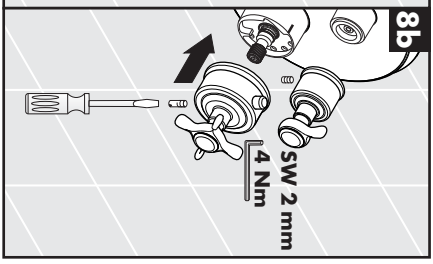
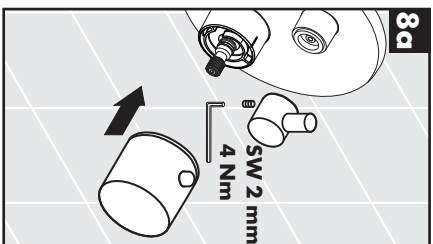
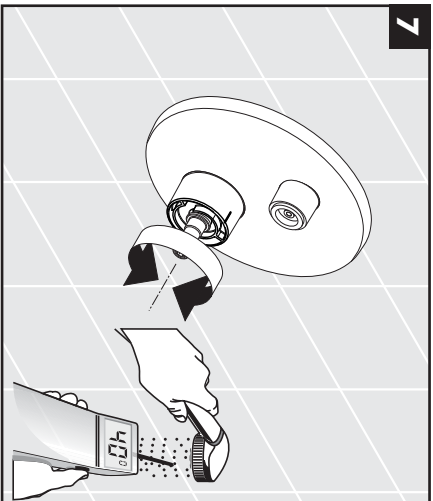



Starck
107000000

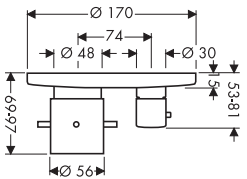

Starck X
107060000

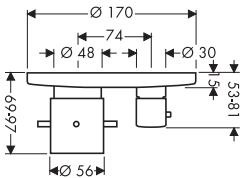

Carlton
177000000

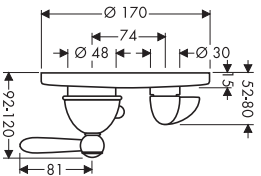

Carlton
177050000

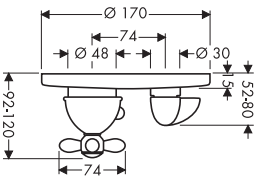

Citterio
397000000

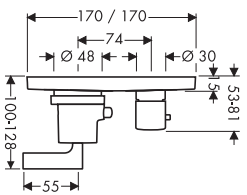

Massaud
187450000

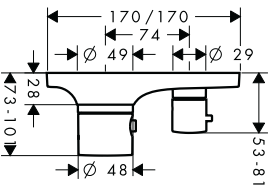

Citterio M
347050000

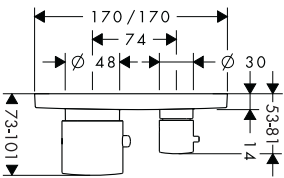

Uno
387000000

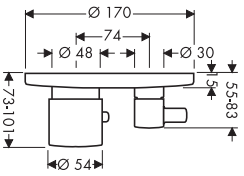

Citterio
397050000

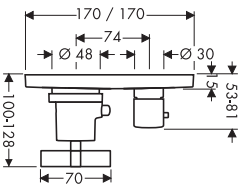

Starck Organic
127150000

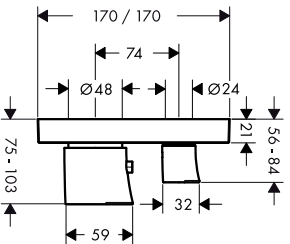

Montreux
168000000

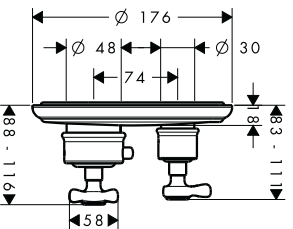

Bouroullec
197040000

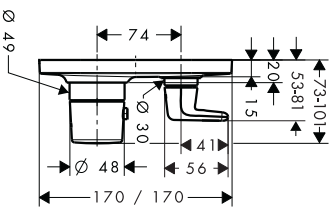

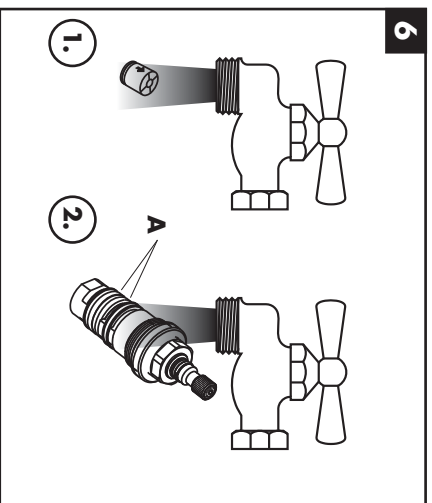
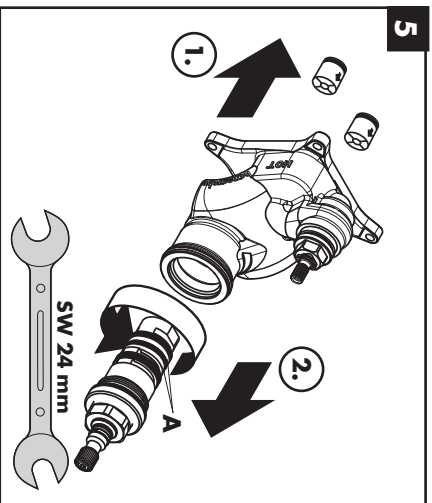
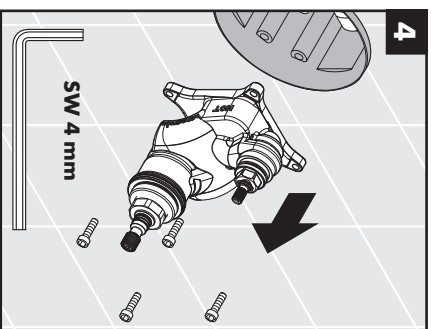
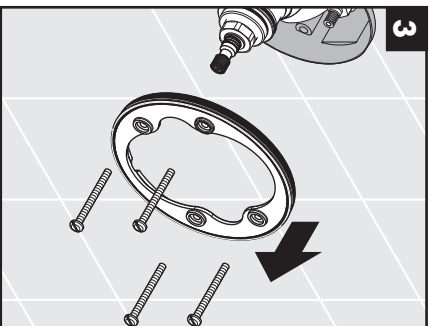
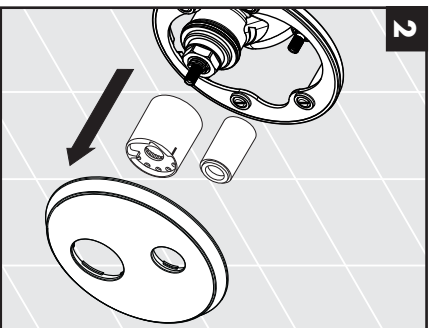
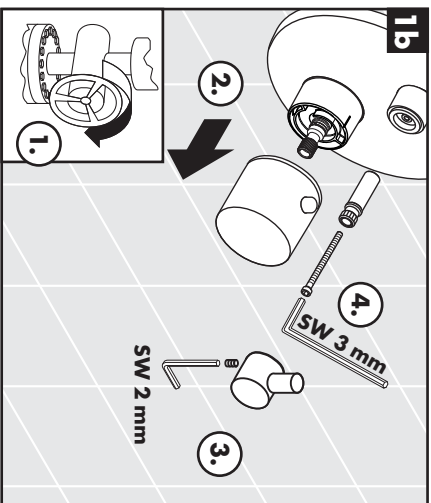
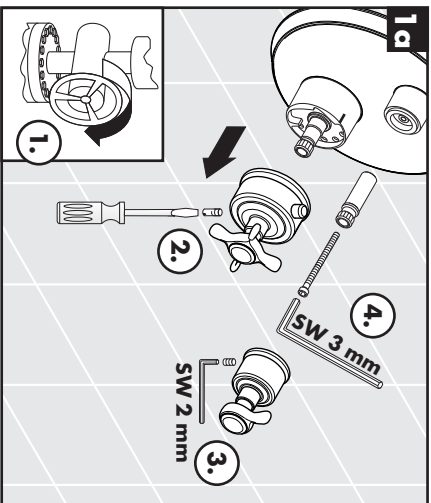

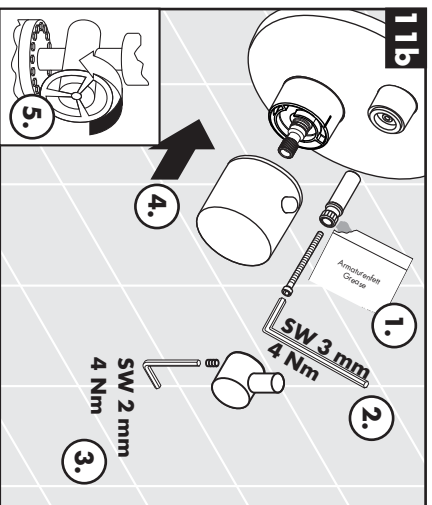
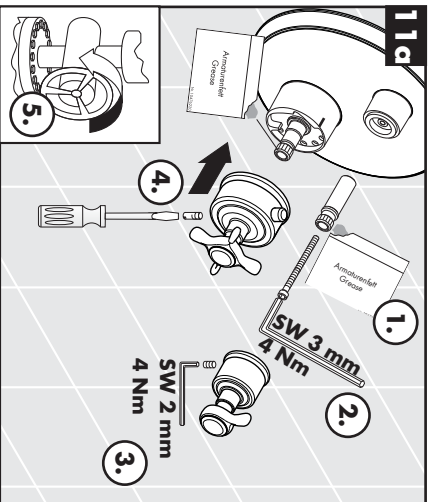
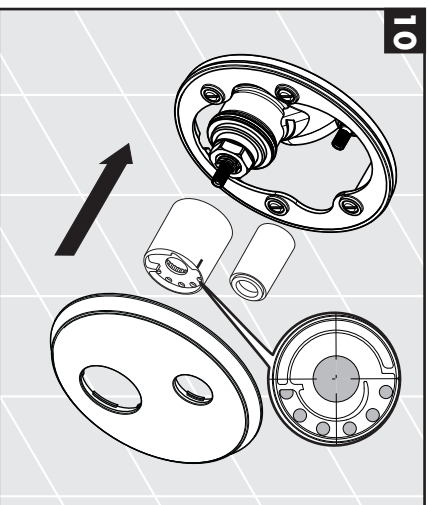
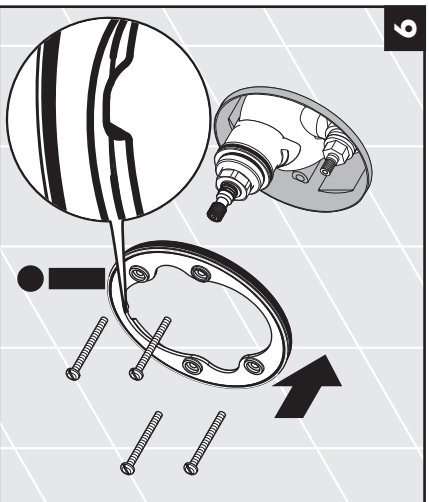
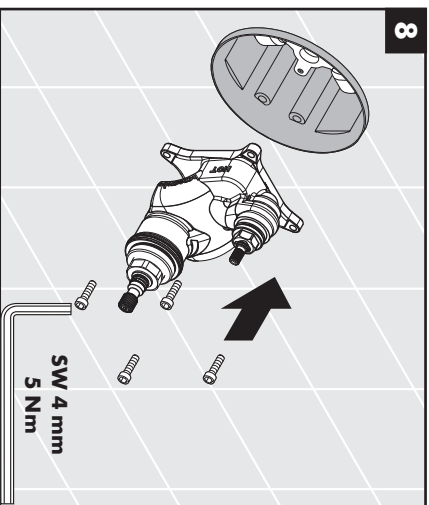
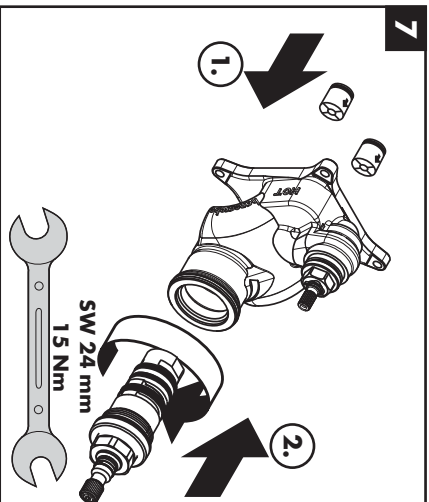

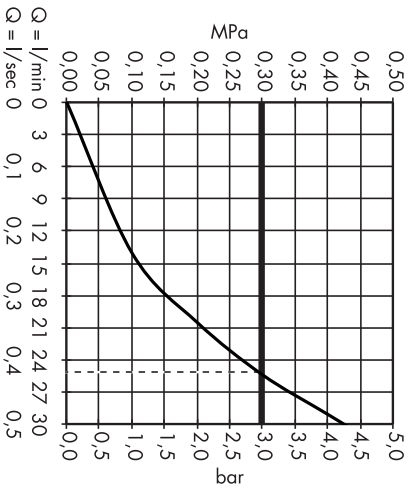

	P-IX	DVGW	MCA	SVGW	WRAS	KIWA	NF	ACS	ETA
10700000	PA-IX 9711/ID	X	X	X	X	X	X	X	Va1.43/18753
10706000	PA-IX 9711/ID	X	X	X	X	X	X	X	Va1.43/18753
12715000	PA-IX 9711/ID		X					X	
16800XXX	PA-IX 9711/ID	X	X	X	X	X	X	X	Va1.43/18753
17700XXX	PA-IX 9711/ID	X	X	X	X	X	X	X	Va1.43/18753
17705XXX	PA-IX 9711/ID	X	X	X	X	X	X	X	Va1.43/18753
18745000	PA-IX 9711/ID	X	X	X	X	X	X	X	Va1.43/18753
19704000	PA-IX 9711/ID	X	X	X	X	X	X	X	Va1.43/18753
34705000	PA-IX 9711/ID	X	X	X	X	X	X	X	Va1.43/18753
38700000	PA-IX 9711/ID	X	X	X	X	X	X	X	Va1.43/18753
39700000	PA-IX 9711/ID	X	X	X	X	X	X	X	Va1.43/18753
39705000	PA-IX 9711/ID	X	X	X	X	X	X	X	Va1.43/18753



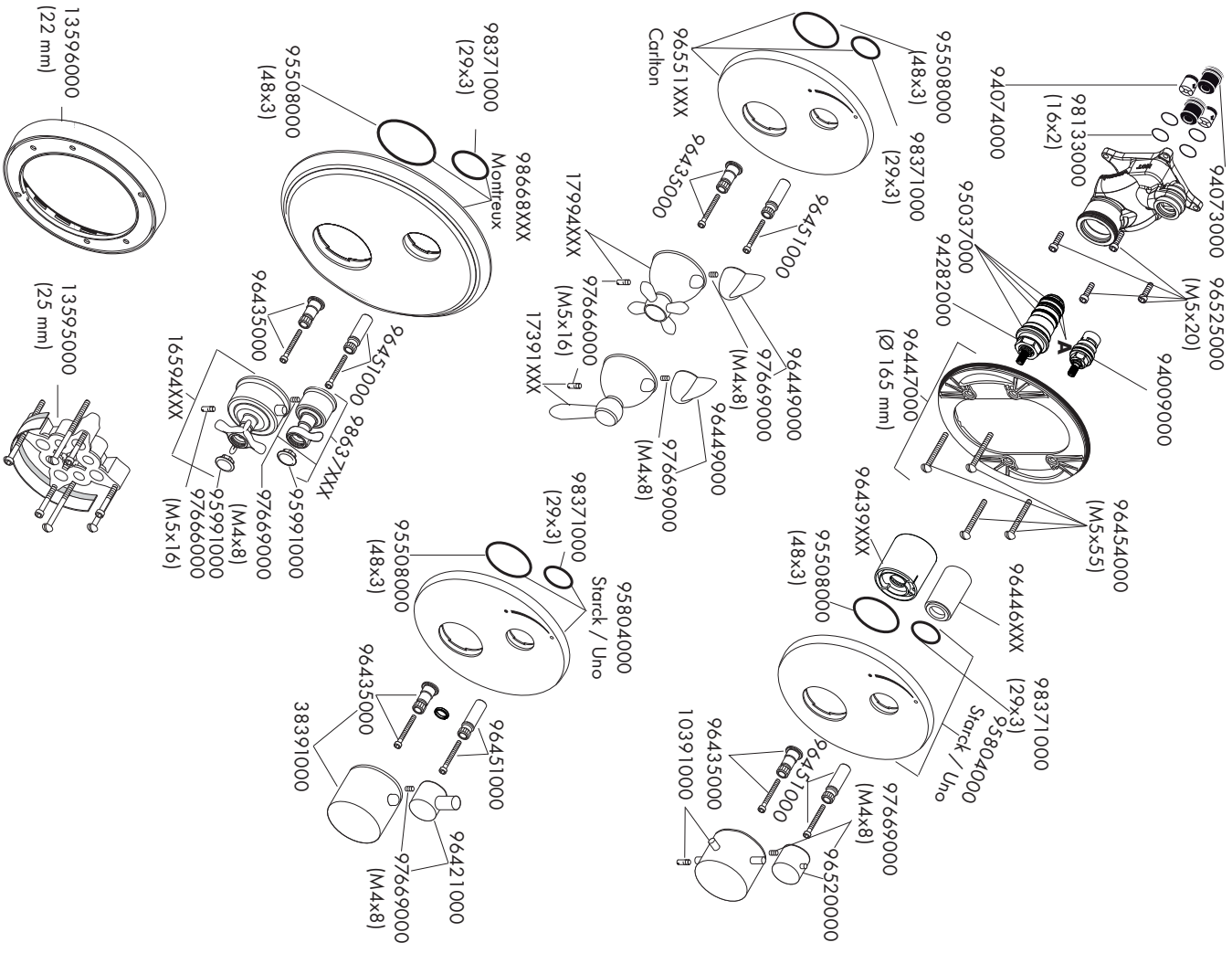



Starck X 10706000 / Citherio 39700000 / Citherio 39705000

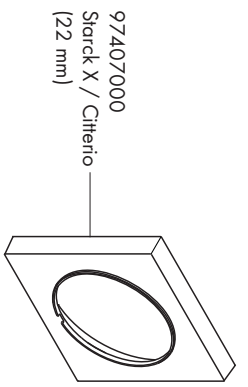
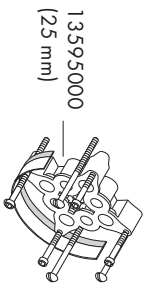
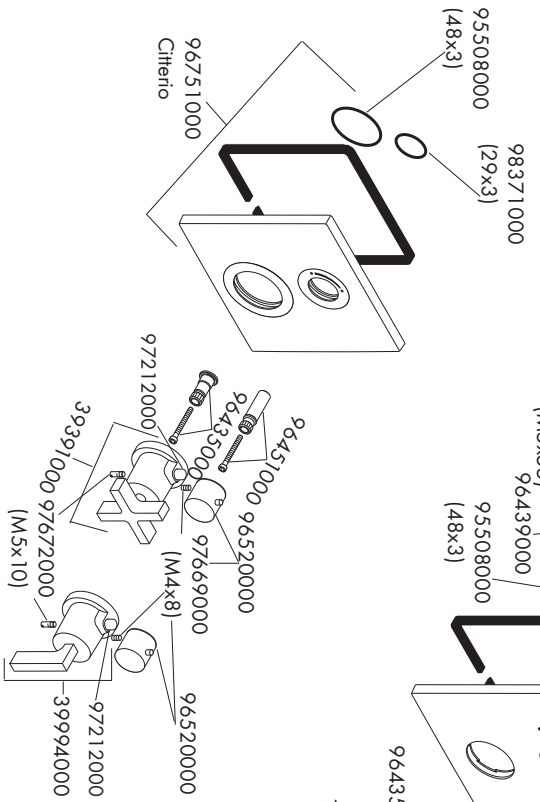
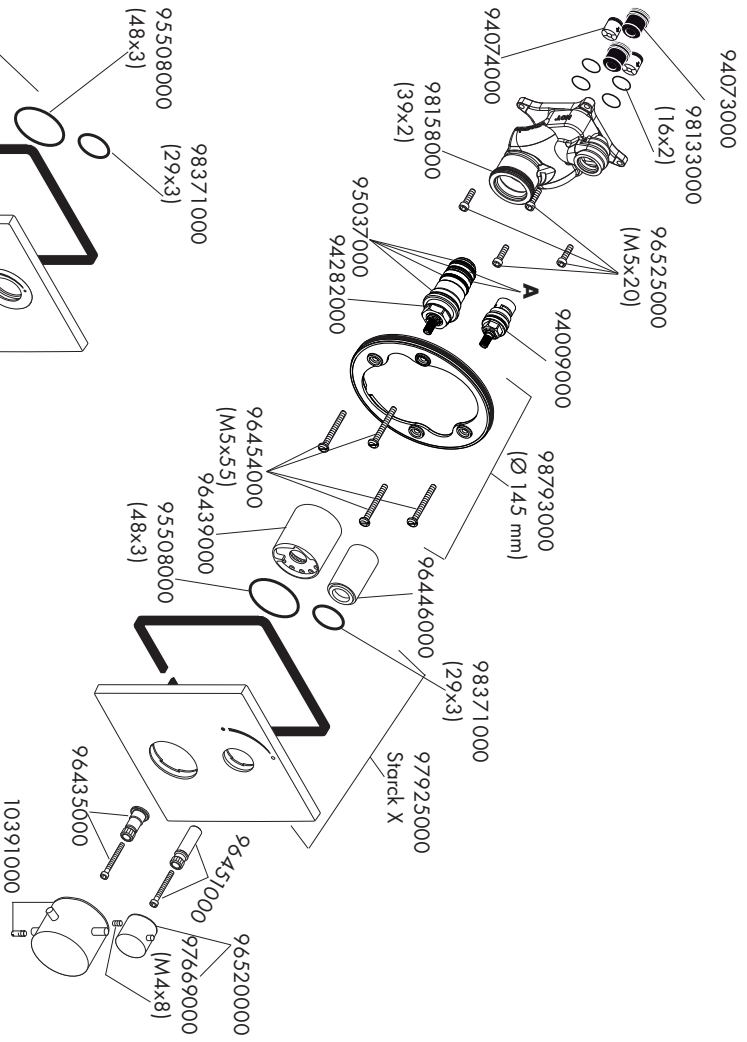

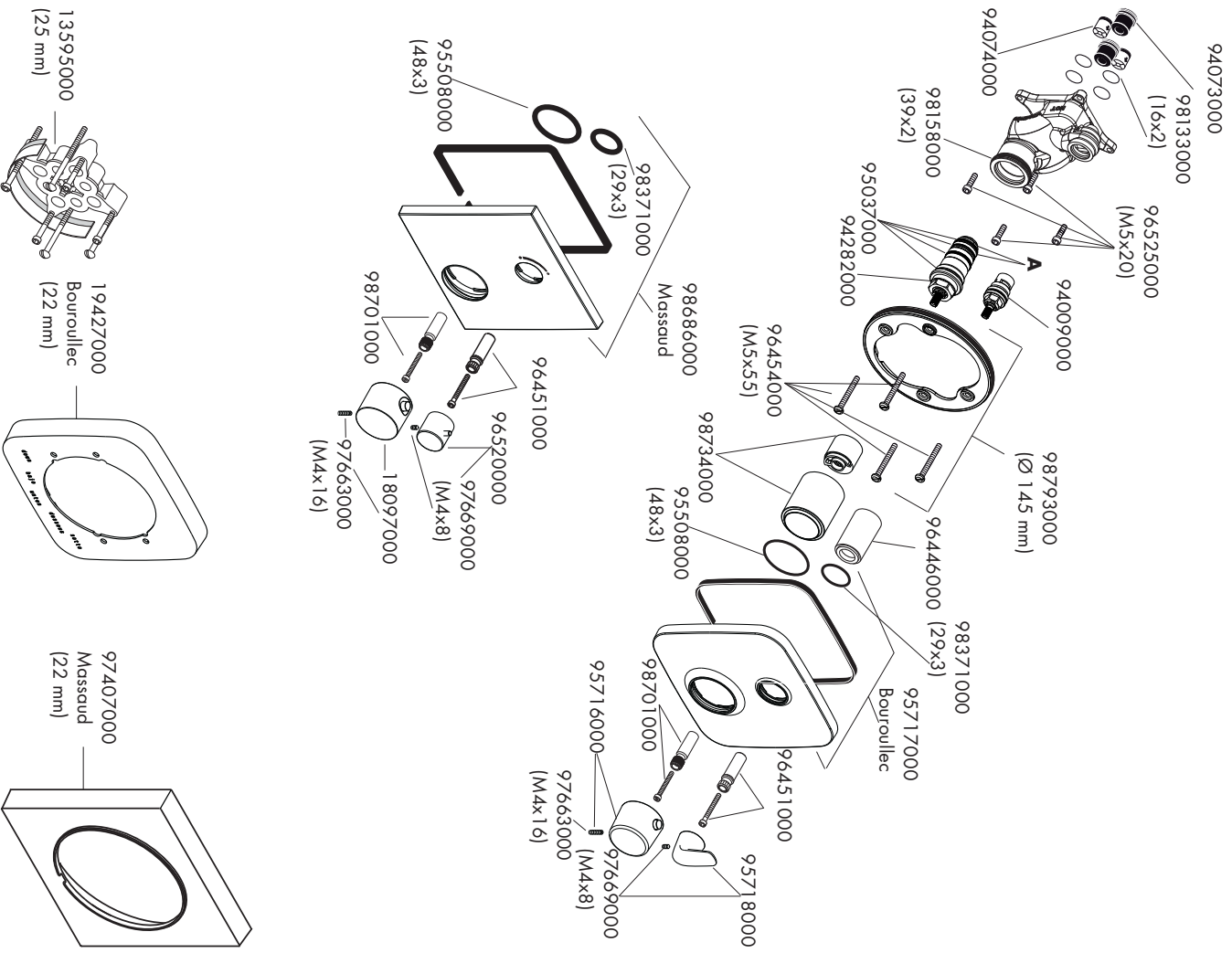



Citterio M 34705000 / Starck Organic 12715000

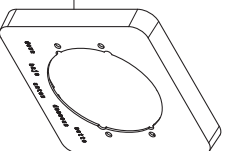
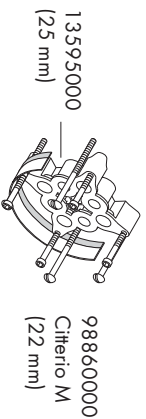
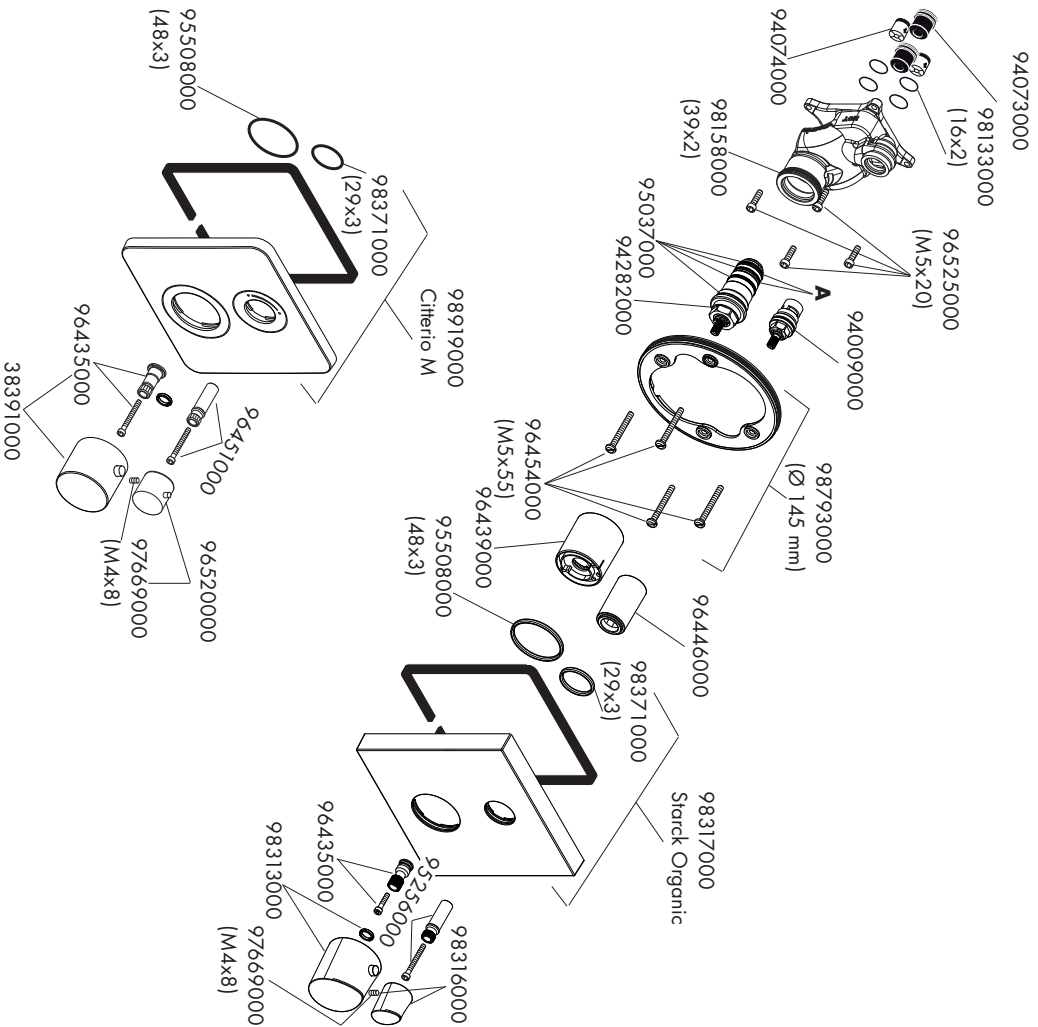

97407000 Starck Organic (22 mm)

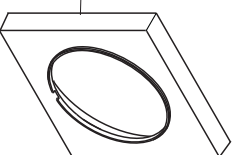



On the following pages 73 - 78 you can find important information only for the installation in UK

Safety and Important Information

Hansgrohe products are safe provided they are installed, used and maintained in accordance with these instructions and recommendations.

Please read these instructions thoroughly and retain for future use.

The plumbing installation of this thermostat mixing valvemust comply with the requirements of UK Water Regulations/Bylaws (Scotland), Building Regulations or any other regulations specified by the local Water Authority and supplier.

The installation of thermostatic mixing valves must comply with the requirements of the Water Supply (Water Fittings) Regulations 1999.

We strongly recommend that you use a plumber registered with or a member of an Association:

Chartered Institute of Plumbing and Heating Engineering (CIPHE)
Water Industry Approved Plumber Scheme (WIAPS)

Dispose of plastic bags carefully

Keep children well away from the work area.

Check for hidden pipes and cables in the wall before drilling holes.

The unit must be mounted on a finished waterproofed wall surface (usually tiles).

If you are using power tools (e.g. to drill holes) wear safety glasses and always disconnect tools from the power supply after use.

Do not operate the shower unit if the hand shower or spray hose has been damaged or is blocked.

Do not block the flow of water from the hand shower, by placing it on your hand or any other part of your body or foreign object.

The thermostatic unit should be serviced annually by a qualified person to ensure maximum safety during use.

The mixer is fitted with check valves (page 69 - 72 pos. 94074000). There are filters on the thermostatic element too (page 69 - 72 pos. A).

The fitting of isolation valves is required (preferred location page 75 Installation Requirements)

Technical Data

This thermostatic valve will suit supplies of:
HIGH PRESSURE (HP-S)

Operating pressure:	max. 10 bar
Recommended operating pressure:	1 - 5 bar
Test pressure:	16 bar
Hot water temperature:	max. 80 °C
Recommended hot water temp.:	65 °C
Rate of flow:	25 l/min. @ 3 bar
Maximum outlet temperature:	43 °C +/-*
Safety check:	40 °C
Hot water connection:	Left hand
Cold water connection:	Right hand
Minimum difference between hot water and mixed water temperature:	6 K
Hot and cold supply pressure should be balanced	

Mixed water temperature

Application Mixed water temperature
(at point of discharge).

Shower	41 °C max.
Washbasin	41 °C max.
Bath (44 °C fill)	44 °C max.
Bath (46 °C fill)	46 °C max.

* For preset outlet temperature adjustment – See page 63.

NB. If a water supply is fed by gravity, then the supply pressure should be verified to ensure the conditions of use are appropriate for the valve. Valves operating outside of these supply conditions cannot be guaranteed to operate as a TMV2 or TMV3 valve.

Recommended outlet temperatures

The BuildCert TMV scheme recommends the following set maximum mixed water outlet temperatures for use in all premises:

- 44 °C for bath fill but see notes below;
- 41 °C for showers;
- 41 °C for washbasins;

The mixed water temperatures must never exceed 46 °C. The maximum mixed water temperature can be 2 °C above the recommended maximum set outlet temperatures.

Note: 46 °C is the maximum mixed water temperature from the bath tap. The maximum temperature takes account of the allowable temperature tolerances inherent in thermostatic mixing valves and temperature losses in metal baths. It is not a safe bathing temperature for adults or children. The British Burns Association recommends 37 to 37.5 °C as a comfortable bathing temperature for children. In premises covered by the Care Standards Act 2000, the maximum mixed water outlet temperature is 43 °C

Supply Conditions TMV2

Operating pressure range

High pressure

Maximum static pressure - bar	10
Flow pressure, hot and cold - bar	0.5 to 5
Hot supply temperature - °C	55 to 65
Cold supply temperature - °C	5 to 25

Supply Conditions TMV3

Operating pressure range

High pressure

Maximum static pressure - bar	10
Flow pressure, hot and cold - bar	1 to 5
Hot supply temperature - °C	52 to 65
Cold supply temperature - °C	5 to 20

Installation Requirements

This thermostatic mixer valve must be installed in compliance with current Water Regulations. If you have any doubts about the Water Regulation requirements contact your local water services provider or use the services of a professional plumber.

This mixer valve is suitable for use with the following water supply systems:

- Gas Combination Boiler (multi-point) 1.0 - 10 bar*
- Unvented System (pressure balanced) 1.0 - 10 bar
- Pumped System 1.0 - 10 bar

IMPORTANT: If you install this mixer with a gravity fed system, there must be a minimum head (vertical distance) from the underside of the cold water storage tank to the showerhead position of at least 5 metre.

Before connecting the mixer, water should be flushed through the system to remove all debris that might otherwise damage the valve.

* If pressure is in excess of 3.5 bar, a pressure-reducing valve should be fitted.

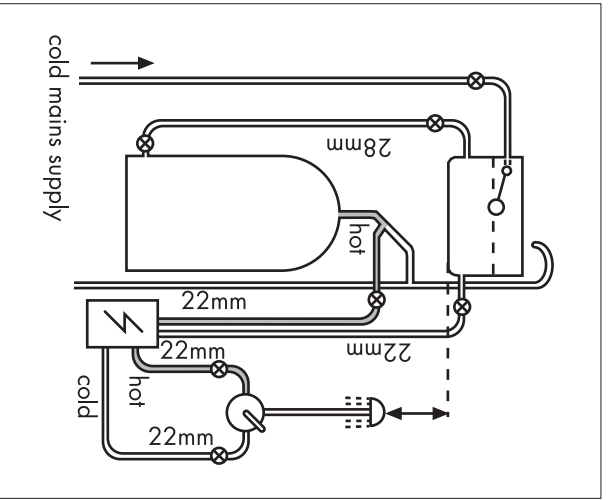
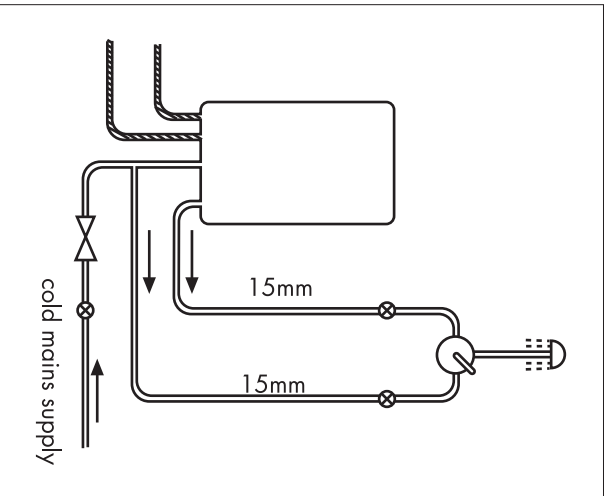
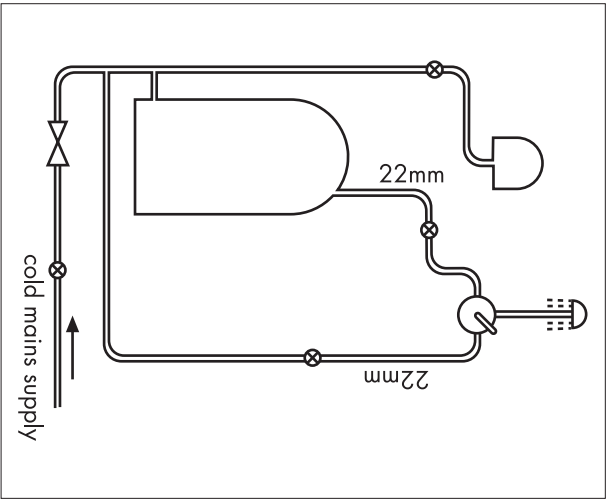
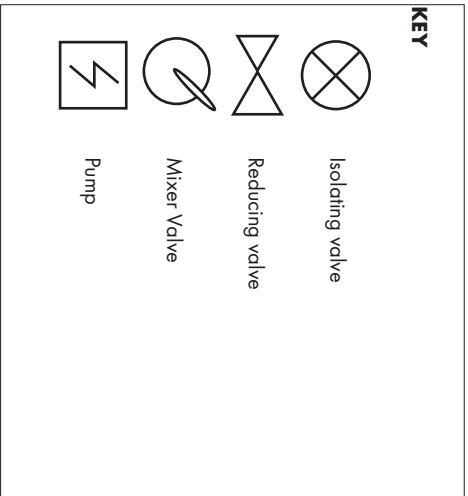

Commissioning and in-service tests

Commissioning

Purpose

Since the installed supply conditions are likely to be different from those applied in the laboratory tests it is appropriate, at commissioning, to carry out some simple checks and tests on each mixing valve to provide a performance reference point for future in-service tests.

Procedure

1. Check that:

- a) the designation of the thermostatic mixing valve matches the intended application
- b) the supply pressures are within the range of operating pressures for the designation of the valve
- c) the supply temperatures are within the range permitted for the valve and by guidance information on the prevention of legionella etc.

2. Adjust the temperature of the mixed water in accordance with the manufacturer's instructions (page 63) and the requirement of the application and then carry out the following sequence:

- a) record the temperature of the hot and cold water supplies
- b) record the temperature of the mixed water at the largest draw-off flow rate
- c) record the temperature of the mixed water at a smaller draw-off flow rate, which shall be measured
- d) isolate the cold water supply to the mixing valve and monitor the mixed water temperature
- e) record the maximum temperature achieved as a result of (d) and the final stabilised temperature

NOTE: The final stabilised mixed water temperature should not exceed the values in Table A.

- f) record the equipment, thermometer etc. used for the measurements

Table A: Guide to maximum stabilised temperatures recorded during site tests

Application	Mixed water temperature
Shower	43 °C
Washbasin	43 °C
Bath (44 °C fill)	46 °C
Bath (46 °C fill)	48 °C

The mixed water temperature at terminal fitting should never exceed 46°C.

If there is a residual flow during the commissioning or the annual verification (cold water supply isolation test), then this is acceptable providing the temperature of the water seeping from the valve is no more than 2 °C above the designated maximum mixed water outlet temperature setting of the valve.

Temperature readings should be taken at the normal flow rate after allowing for the system to stabilise.

The sensing part of the thermometer probe must be fully submerged in the water that is to be tested.

Any TMV that has been adjusted or serviced must be re-commissioned and re-tested in accordance with the manufacturer's instructions.

In-service tests

Purpose

The purpose of in-service tests is to regularly monitor and record the performance of the thermostatic mixing valve. Deterioration in performance can indicate the need for service work on the valve and/ or the water supplies.

Procedure

1. Carry out the procedure **2.** (a) to (e) on page 76 using the same measuring equipment, or equipment to the same specifications.
2. If the mixed water temperature has changed significantly from the previous test results (e.g. > 1 K), record the change and before re-adjusting the mixed water temperature check:
 - a) that any in-line or integral strainers are clean
 - b) any in-line or integral check valves or other anti-backsiphonage devices are in good working order
 - c) any isolating valves are fully open
3. With an acceptable mixed water temperature, complete the procedure **2.** (a) to (e) on page 76.
4. If at step **2.** (e) on page 76 the final mixed water temperature is greater than the values in Table A and / or the maximum temperature exceeds the corresponding value from the previous test results by more than about 2 K, the need for service work is indicated.

NOTE: In-service tests should be carried out with a frequency which identifies a need for service work before an unsafe water temperature can result. In the absence of any other instruction or guidance, the procedure described in „Frequency of in-service tests“ may be used.

Frequency of in-service tests TMV3*

General

In the absence of any other instruction or guidance on the means of determining the appropriate frequency of in-service testing, the following procedure may be used:

1. 6 to 8 weeks after commissioning carry out the tests given in **2.** on page 76.
2. 12 to 15 weeks after commissioning carry out the tests given in **2.** on page 76.

3. Depending on the results of **1.** and **4.** several possibilities exist:

- a) If no significant changes (e.g. ≤ 1 K) in mixed water temperatures are recorded between commissioning and **1.**, or between commissioning and **4.** the next in-service test can be deferred to 24 to 28 weeks after commissioning.
- b) If small changes (e.g. 1 to 2 K) in mixed water temperatures are recorded in only one of these periods, necessitating adjustment of the mixed water temperature, then the next in-service test can be deferred to 24 to 28 weeks after commissioning.
- c) If small changes (e.g. 1 to 2 K) in mixed water temperatures are recorded in both of these periods, necessitating adjustment of the mixed water temperature, then the next in-service test should be carried out at 18 to 21 weeks after commissioning.
- d) If significant changes (e.g. > 2 K) in mixed water temperatures are recorded in either of these periods, necessitating service work, then the next in-service test should be carried out at 18 to 21 weeks after commissioning.

4. The general principle to be observed after the first 2 or 3 in-service tests is that the intervals of future tests should be set to those which previous tests have shown can be achieved with no more than a small change in mixed water temperature.

***TMV2: The frequency of performing the in-service tests is 1 year maximum.**

Thermostatic Adjustment

Temperature Limitation

The temperature is limited by the safety stop to 40° C. If a higher temperature is required, it is possible to override the safety stop by depressing the safety button.

NB. It is recommended that for **private domestic use** the maximum mixed water temperature be set at the following factory set values:

Shower Mixer 43° C
Bath/Shower 43° C

Temperatures can be set by following the procedures on page 63. This ensures that after correct installation the outlet temperature of the water can never exceed 43° C.

To guarantee a smooth running of the thermostatic element, it is necessary from time to time to turn the thermostat from total hot to total cold. The thermostatic mixer valve should be checked annually by a qualified person to ensure correct operation.

The mixer is fitted with check valves (page 69 - 72 pos. 94074000) and filters (page 69 - 72 pos A). If the water flow drops the filters need to be cleaned. For that purpose please follow the steps 1 - 11 on page 66.

Calibrating Thermostat

If the temperature reading is different to the showering temperature, follow the steps 1 - 3 on page 62.

Technical Hotline

0 870 7701975

E-mail

Technical@hansgrohe.co.uk



hansgrohe

Hansgrohe · Auestraße 5 · 9 · D-77761 Schiltach · Telefon +49 (0) 78 36/51-1282 · Telefax +49 (0) 7836/511440
EMail: info@hansgrohe.com · Internet: www.hansgrohe.com

01/2014
9.09121.12