

hansgrohe

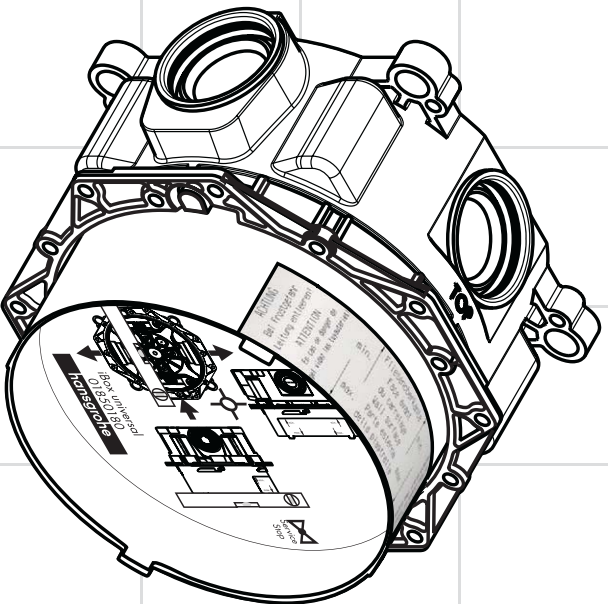

iBox universal

01850180

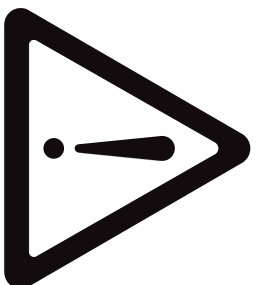
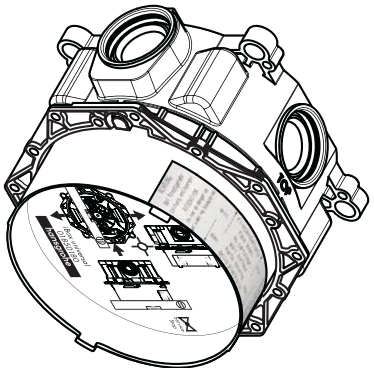

Vordsperrung pointeau d'arrêt Isolation valve Rubineth arresto Válvula de cierre Vóratstülper Forspærre Válvula de isolamento Oddzielacz wstępny izolaci ni venili Uzatvárací venilí 隔離閥 Предварительная блокировка Előlezáras Esisukkuventiili	Säkerhetspörr Uzdatumo vozilvas Predhna izolacija On kesme Venilí de închidere la intrare Διπαράη προκαταβολικής φραγής Izolacijski venilí eellökkesti Izolācijas vārstis Pretlodna blokada Förhåndsperre Предварительно блокиране Blökiimi ratararak
-------------------------------------------------------------------------------------------------------------------------------------------------------------------------------------------------------------------------------------------------------------------------------------------	-------------------------------------------------------------------------------------------------------------------------------------------------------------------------------------------------------------------------------------------------------------------------------------------

صمام العزل

schließen / termé / close / chiudere /
cerrar / shtien / lukke / fechar /
zamykatć / zavřít / uzavriet / 关 /
закрыть / bezárás / sulkeminen /
stänga / uždaryti / Zshvanen /
kapatmak / închide / κλειστό / zapretí /
sulgege / aizvērt / zavřiti / lukke /
zastvarnē / mbylle / علق

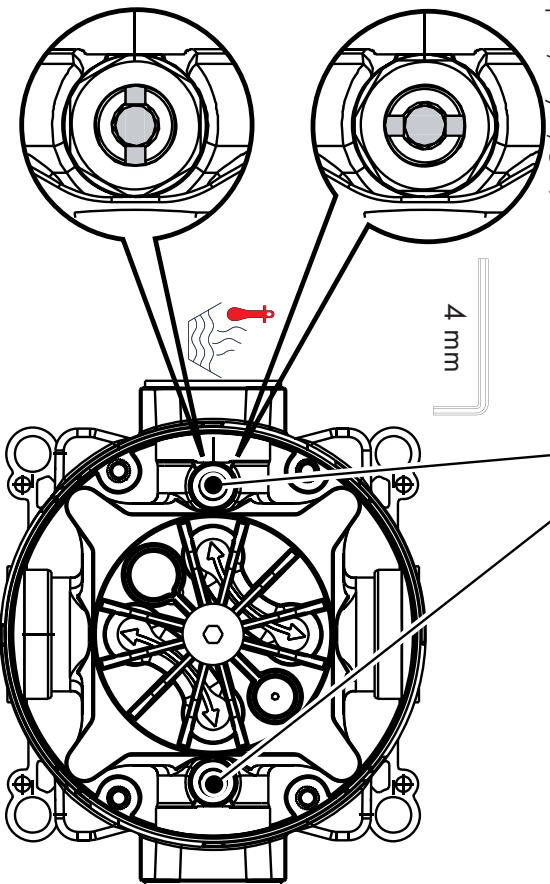

öffnen / ouvert / open / aperto / abierto / open / åbne /
dbiri / otkrytć / otevřít / otvorit / 开 / otкрыt / nyitás /
avaaminen / öppna / atidaryti / Otvoranje / açmak /
deschide / avakto / odgřeti / avage / åbvert /
otvoriti / åpne / otvarnē / høre / فتح

Rohmontage

Der rotationsymmetrische Grundkörper der iBox ist universell einsetzbar, horizontal wie vertikal. Ausgenommen bei der Montage der Wannennarmatur mit Sicherungskombination, hier ist nur der vertikale Einbau möglich. Da bei einem Defekt der Funktionsteile Wasser an der iBox austreten kann, muss die iBox über der Wanne montiert werden, damit austretendes Wasser in die Wanne abfließen kann!

Die iBox ist sowohl für Warmen- als auch für Brauseninstallation geeignet. Bei Einhand Wannemischer / Thermostat mit Absper- und Umstellventil ist der untere Abgang vorrangig. Bei Brauseninstallation muss der nicht benötigte Abgang mit einem Stopfen abgedichtet werden.

Große Druckunterschiede zwischen den Kalt- und Warmwasserschläüssen müssen ausgeglichen werden.

Grundkörper so einbauen, daß sich der Warmwasseranschluß links und der Kaltwasseranschluß rechts befindet. Einbautiefe 80 mm bis 108 mm.

Verlängerung 25 mm Artikelnummer 13595000

Verlängerung 22 mm (bei geringer Einbautiefe)

Artikelnummer 13593000 / 13596XXX / 13597XXX / 15597000 / 19427000 / 97407XXX / 98860000

Der Grundkörper kann entsprechend der baulichen Gegebenheiten montiert werden (Montagebeispiele siehe Seite 91 und 92).

- A** Installation auf die Wand.
- B** Installation auf die Wand. Hier mit flexiblem Abstandshalter durch 10er Stockschrauben.
- C** Montage auf Trägersystem.
- D** Installation auf Fertighaus-Montageplatten oder Fertiggelände.
- E** Installation direkt in die Wand.
- F** Installation mit Montageschlenkset #92615000.

Installationsbeispiele mit Maßangaben und Leitungsschemen sind ab Seite 96 zu finden. Die Erläuterung der verwendeten Symbole auf Seite 3 und 4.

Die in der Montageanleitung angegebenen Montagemaße sind ideal für Personen von ca. 1800 mm Körpergröße und müssen gegebenenfalls angepasst werden. Hierbei ist darauf zu achten, dass sich bei geänderter Montagehöhe die Mindesthöhe ander und die Änderung der Anschlussmaße berücksichtigt werden müssen.

Montage-Tipp

Um Anschlussstücke einzudrehen, die iBox mittels eines Rohstücks in den Schraubstock einspannen.

Spülen

Komplette Installation gemäß DIN 1988 / EN 1717 spülen. Die Peile auf dem Spülblock zeigen, welcher Zulauf mit welcher Abgangseitung verbunden ist, z. B. Kaltwasser mit Abgang 1 und Warmwasser mit Abgang 2. Falls nur ein Abgang benötigt wird, muß nach dem ersten Spülvorgang der Spülblock um 90° gedreht werden.

iBox in Kombination mit einer Exfill Wanneneinlauf mit Ab- und Überlaufgarnitur (siehe Seite 95)

Technische Daten

Betriebsdruck:	max. 1 MPa
Empfohlener Betriebsdruck:	0,1 - 0,5 MPa
Prüfdruck:	1,6 MPa
(1 MPa = 10 bar = 147 PSI)	
Heißwassertemperatur:	max. 80°C
Empfohlene Heißwassertemperatur:	65°C
Anschlussmaße:	G ¾
Anschlüsse:	kalt rechts - warm links
Freier Durchfluss bei 0,3 MPa:	31 l/min // 24 l/min
Warnmischer:	25 l/min // 24 l/min
Wannemischer mit integrierter Sicherungskombination:	32 l/min
Brausemischer:	32 l/min
Thermostat:	43 l/min
Thermostat mit Absperventil:	26 l/min
Thermostat mit Absper- und Umstellventil:	26 l/min
Thermostat High Flow:	58 l/min
iControl:	30 l/min

Deutsch

X

Mitte Bodewanne / Mitte Duschwanne



Unterputz-Ventil

Y

Maß Y – Mitte Schlauchanschlussbogen bis Mitte Wanneneinlauf dividiert durch 2 (eventuell dem Fliesenraster anpassen).



Quattro Verwegeumstellung

Quattro

Warmwasser

Trio Universal Absperr- und Umstellventil

Kaltes Wasser



Trio

Ab • ist die Funktion gewährleistet.

Wanneneinlauf



In diesem Bereich ist eine Wandverstärkung notwendig.



Nur ein Verbraucher möglich, nicht zwei gleichzeitig.



Wasserleitungen für Seitenbrausen mit Gefälle verlegen.



Der nicht benötigte Abgang muss mit einem Blindstopfen abgedichtet werden. (DN 20 3/4")

Die Ablaufleistung muss mehr als 50 l/min betragen.



> 50 l/min

Ablauf



Spülblock kpl. #15956000, nicht im Lieferumfang enthalten



Raindrain



iBox in Kombination mit einer Exofill Wanneneinlauf mit Ab- und Überlaufgarnitur (siehe Seite 95)

DVGW



Wannemischer mit integrierter Sicherungskombination (siehe Seite 96)



Brausemischer (siehe Seite 104, 106, 110, 124)



Wanneneinlauf (siehe Seite 98, 102, 114, 116)

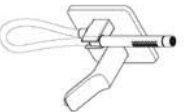

Wanneneinlauf (siehe Seite 102)

Thermostat
(siehe Seite 118, 122, 126)



High Flow Thermostat
(siehe Seite 128 - 138, 142, 144,
150 - 158)



Thermostat mit Absperrenventil
(siehe Seite 104, 106, 110, 124)



Thermostat mit Absperren- und Umstellventil
(siehe Seite 98, 114, 116, 120)



High Flow Thermostat mit Absperrenventil
(siehe Seite 140, 146, 148)

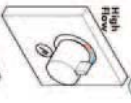

Thermostat mit Absperrenventil
(siehe Seite 104, 106, 110)



Thermostat mit Absperrenventil
(siehe Seite 98, 114, 116, 120)

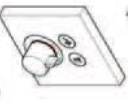

Thermostat mit Absperrenventil
(siehe Seite 100, 112)



ShowerSelect Brausenischer
(siehe Seite 104, 106, 110)

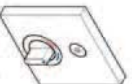

ShowerSelect Wannensischer
(siehe Seite 98, 114, 116, 120)



!Kontrolle
Absperren- und Umstellventil (siehe Seite 150)



ShowerSelect
3 x Absperrenventil (siehe Seite 144,
146 - 150, 158)

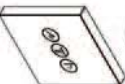

Raindance Showerpepe
(siehe Seite 108)



Raindance Rainfall 240
(siehe Seite 140, 142)



Raindance Rainfall 180
(siehe Seite 154 - 158)



Raindance E 420
(siehe Seite 150, 152)



Raindance Select E 300
(siehe Seite 148)

Montage de base

La pièce de base rotative symétrique de l'iBox a une possibilité de montage universel, horizontal comme vertical. Sauf pour le montage d'un mitigeur bain-douche avec disconnecteur ou la le montage vertical seulement est possible. Parceque l'eau pourrait fuir de l'iBox en cas de défaillance des pièces de fonctionnement, l'iBox doit être monté au dessus de la baignoire pour que la fuite puisse s'écouler dans la baignoire.

L'iBox est appropriée aussi bien pour les baignoires que pour les douches. Pour un mitigeur bain/douche / mitigeur thermostatique avec robinet d'arrêt et inverseur, la sortie inférieure est prioritaire. Pour une installation de douche, la sortie non utilisée doit être condamnée avec un bouchon.

Il est conseillé d'équilibrer les pressions de l'eau chaude et froide.

Monter la pièce de base pour que l'eau chaude arrive sur le côté gauche et l'eau froide sur le côté droit.

Profondeur d'encastrement: 80 mm à 108 mm.

Jeau de rallonge 25 mm référence 13595000

Rallonge de 22 mm (pour profondeur de montage trop faible)

référence 13593000 / 13596XXX / 13597XXX / 1597000 / 19427000 / 97407XXX / 988600000

La pièce de base peut être installée selon les différentes possibilités voir pages 91 et 92).

- A** Installation au mur.
- B** Installation au mur avec une vis de distance.
- C** Montage sur système support.
- D** Installation sur des panneaux de montage préfabriqués.
- E** Installation directement dans le mur.
- F** Installation avec rail de fixation #76615000.

Des exemples d'installation avec indication de cotes et dimensions des conduites sont fournis à partir de la page 96. Les symboles utilisés sont expliqués à la page 6 et 7.

Les dimensions d'installation indiquées dans la notice de montage sont idéales pour des personnes d'une taille de 1800 mm environ et doivent être ajustées selon le cas. Tenir compte pour cela du fait qu'un changement de hauteur modifie la hauteur minimum et que la modification des cotes de raccord doit entrer en ligne de compte.

Exemple de montage

Pour monter les différents raccords, on peut fixer l'iBox grâce à un tuyau et un étou.

Rinçage

Rincer l'installation complète conformément à la réglementation et aux normes. Les flèches sur le bloc de rinçage indiquent l'arrivée et la sortie qui doivent être raccordés, par exemple eau froide avec sortie 1 et eau chaude avec sortie 2. Si on utilise seulement une sortie, on devra après le premier rinçage tourner de 90° le bloc de rinçage.

iBox en combinaison avec un remplissage exafill avec mécanisme de vidage et de trop-plein (voir page 95)

Informations techniques

Pression de service autorisée:	max. 1 MPa
Pression de service conseillée:	0,1 - 0,5 MPa
Pression maximum de contrôle: (1 MPa = 10 bar = 147 PSI)	1,6 MPa
Température d'eau chaude:	max. 80°C
Température recommandée:	65°C
Dimension d'arrivée:	G¾
Raccordement:	froide à droite - chaude à gauche
Débit libre à 0,3 MPa:	31 l/min // 24 l/min
Mitigeur bains-douches:	
Mitigeur bains-douches avec disconnecteur:	25 l/min // 24 l/min

Mitigeur douche:	32 l/min
Mitigeur thermostatique:	43 l/min
Mitigeur thermostatique avec robinet d'arrêt:	26 l/min
Mitigeur thermostatique avec robinet d'arrêt et inverseur:	26 l/min
Mitigeur thermostatique High Flow:	58 l/min
Control:	30 l/min

X Centre de la baignoire / Centre cuvette de douche



Robinet d'arrêt encastré

Y Dimension Y = du centre raccord coudé de douche au centre bec déverseur divisé par 2 (éventuellement s'adapter au carrelage).



Quattro Inverseur quatre voies

Eau chaude



Trio Robinet d'arrêt avec inverseur

Eau froide



A partir de • le fonctionnement est garanti.



Bec déverseur

Le mur n'a pas besoin d'être renforcé à cet endroit



La sortie non utilisée doit être condamnée avec un bouchon lation. (DN 20 3/4")

Une seule utilisation possible, pas les deux ensemble.



Le débit de vidage doit être supérieur à 50 l/min.

La tuyauterie des douchettes latérales à installer avec une pente.



Vidage



bloc d'essai # 159,56000, ne fait pas partie de la fourniture



Box en combinaison avec un remplissage exaill avec mécanisme de vidage et de trop plein (voir page 95)

DVGW

Mitigeur bains-douches avec disjoncteur (voir pages 96)



Mitigeur douche (voir pages 104, 106, 110, 124)

Mitigeur bains-douches (voir pages 98, 102, 114, 116)

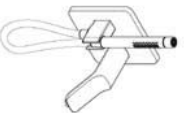

Bec déverseur (voir pages 102)

Mitigeur thermostatique
(voir pages 118, 122, 126)



High Flow Mitigeur thermostatique
(voir pages 128 - 138, 142, 144,
150 - 158)



Mitigeur thermostatique avec robinet
d'arrêt
(voir pages 104, 106, 110, 124)



Mitigeur thermostatique avec robinet
d'arrêt et inverseur
(voir pages 98, 114, 116, 120)



High Flow Mitigeur thermostatique
avec robinet d'arrêt
(voir pages 140, 146, 148)

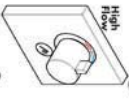

Mitigeur thermostatique avec robinet
d'arrêt
(voir pages 104, 106, 110)

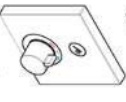

Mitigeur thermostatique avec robinet
d'arrêt
(voir pages 98, 114, 116, 120)

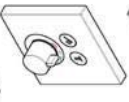

Mitigeur thermostatique avec robinet
d'arrêt
(voir pages 100, 112)



Shower>Select Mitigeur douche
(voir pages 104, 106, 110)

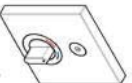

Shower>Select Mitigeur bains-douchas
(voir pages 98, 114, 116, 120)

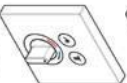

iControl
Robinet d'arrêt et inverseur (voir pages
150)



Shower>Select
3 x robinet d'arrêt (voir pages 144,
146 - 150, 158)

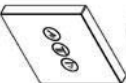

Raindance Showerpipe
(voir pages 108)



Raindance Rainfall 240
(voir pages 140, 142)



Raindance Rainfall 180
(voir pages 154 - 158)

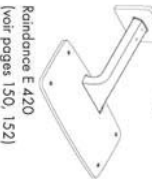

Raindance E 420
(voir pages 150, 152)

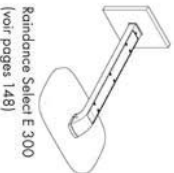

Raindance Select E 300
(voir pages 148)

Concealed installation

The rotation symmetrical body is horizontal and vertical usable. Only exception installing the bath-shower mixer with integrated safety combination. In this case only a vertically installation is possible. Install the iBox always above the bath-tub. If parts of the iBox will broken, the water can flow in there!

The iBox is suitable for both bath and shower applications. When using the bath-shower mixer / thermostatic mixer with shut off and diverter unit outlet, the lower outlet must have priority. For shower applications, plug the unused outlet with a plug.

The hot and cold supplies must be of equal pressures.

The hot body with the hot water supply left and cold water supply right.

Depth of fitting: 80 mm to 108 mm.

extension 25 mm article number 13595000

Extension Set 22 mm (when wall is not deep enough).

article number 13593000 / 13596XXX / 13597XXX / 15597000 / 19427000 / 97407XXX / 98860000

The iBox can depending on the building application be mounted in different ways. Installation examples please see page 91 and 92.

- A** Direct wall installation.
- B** Direct wall installation with 10 mm adjustable mounting studs.
- C** Installation on carrier system.
- D** Hollow wall installation.
- E** Brick wall installation.
- F** Installation with fixation set #96615000.

Installation examples with measurements and pipe dimensions can be found starting on page 96. The used symbols are explained on pages 9 and 10.

The installation dimensions stated in these installation instructions are ideal for people of approximately 1800 mm in body height. The dimensions can be altered if required. In this case, pay attention to the fact that a change of installation height will also change the minimum height, and that the altered mounting dimensions must be taken into consideration.

Installation tip

To install the supply pipes, fix the iBox with a pipe in a vice.

Flush piping system

To complete the installation flush out both hot and cold water supply. The arrows on the flush body are showing, which inlet is connected with which outlet, for example cold water supply with outlet 1 and hot water supply with outlet 2. If only one outlet is in use, after first flushing the flush body must turned about 90°.

iBox in combination with an Exafill bath filler with overflow and waste (see page 95)

Technical Data

Operating pressure:	max. 1 MPa
Recommended operating pressure:	0,1 - 0,5 MPa
Test pressure:	1,6 MPa
(1 MPa = 10 bar = 147 PSI)	
Hot water temperature:	max. 80°C
Recommended hot water temp.:	65°C
Centre distance:	G ¾
Connections:	cold right - hot left
Rate of flow by 0,3 MPa:	31 l/min // 24 l/min
Bath-shower mixer:	25 l/min // 24 l/min
Bath-shower mixer with integrated safety combination:	
Shower mixer:	32 l/min
Thermostatic mixer:	43 l/min
Thermostatic mixer with shut off unit:	26 l/min
Thermostatic mixer with shut off and diverter unit:	26 l/min
Thermostatic mixer High Flow:	58 l/min
iControl:	30 l/min

X

Center bath tub / Center shower tub



Shut off valve

Y

Dimension Y = center of hose wall outlet elbow to centre of bath filler divided by 2 (match to tile layout if applicable).

Quattro 4-Way Diverter Valve



Quattro

Warm water

Trio 2-Way Diverter Valve with integrated

Cold water

Shut-off valve



Trio



From • the function is guaranteed.

Bath Spout



The wall must be reinforced in this area.

Plug the unused outlet. [DN 20 3/4"]



Only one function is possible.

The waste drain performance must be more than 50 l/min.



Install water pipes for body showers with a gradient.



Waste



> 50 l/min

Raindrain

Flushing unit complete #15956000, order as an extra



Exofill

!Box in combination with an Exofill both filler with overflow and waste [see page 95]



DVGW

Both-shower mixer with integrated safety combination (see page 96)

Shower mixer (see page 104, 106, 110, 124)



Both-shower mixer (see page 98, 102, 114, 116)

Bath Spout (see page 102)

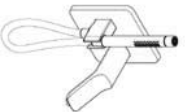



Thermostatic mixer
(see page 118, 122, 126)



High Flow Thermostatic mixer
(see page 128 - 138, 142, 144,
150 - 158)



Thermostatic mixer with shut off unit
(see page 104, 106, 110, 124)



Thermostatic mixer with shut off and
diverter unit
(see page 98, 114, 116, 120)



High Flow Thermostatic mixer with shut
off unit
(see page 140, 146, 148)

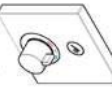

Thermostatic mixer with shut off unit
(see page 104, 106, 110)



Thermostatic mixer with shut off unit
(see page 98, 114, 116, 120)



Thermostatic mixer with shut off unit
(see page 100, 112)



ShowerSelect Shower mixer
(see page 104, 106, 110)



ShowerSelect Bath-shower mixer
(see page 98, 114, 116, 120)



iControl
Shut off and diverter unit (see page
150)



ShowerSelect
3 x stop valve (see page 144, 146 -
150, 158)



Raindance Showerpipe
(see page 108)



Raindance Rainfall 240
(see page 140, 142)



Raindance Rainfall 180
(see page 154 - 158)



Raindance E 420
(see page 150, 152)



Raindance Select E 300
(see page 148)

Installazione della tubazione

La rotazione simmetrica del corpo permette di raccordarsi agli attacchi sia verticalmente che orizzontalmente. Set vasca/doccia con valvola antiriflusso, è obbligatorio. Solo in caso di installazione del raccordarsi agli attacchi verticalmente. Installare sempre l'Box sopra alla vasca o al piatto doccia, poiché in caso di fuoriuscita d'acqua questa verrà convogliata allo scarico.

L'Box è adatto tanto ad installazioni per vasca quanto per doccia. Per i miscelatori monocomando per vasca / termostatico con rubinetto di arresto e deviatore l' uscita inferiore ha la prevalenza. Nelle installazioni per doccia l' uscita non utilizzata deve essere chiusa con un tappo. Attenzioni! Compensare le differenze di pressione tra i collegamenti dell'acqua fredda e dell'acqua calda.

Installare il corpo incasso in modo tale che il raccordo dell' acqua calda si trovi a sinistra e il raccordo dell' acqua fredda a destra.

Profondità d'installazione: da 80 mm a 108 mm.

Prolunga 25 mm codice articolo 13595000

Prolunga 22 mm x set esterno (in caso di incasso troppo esterno al muro).

codice articolo 13593000 / 13596XXX / 13597XXX / 15597000 / 19427000 / 97407XXX / 98860000

Il corpo incasso può essere installato conformemente alle condizioni edilizie, vedi esempi di installazione alle pagg. 91 e 92.

- A** Installazione a muro.
- B** Installazione a muro. Qui con la regolazione della distanza (vite nr 10).
- C** Montaggio su struttura portante.
- D** Installazione per bagni prefabbricati.
- E** Installazione diretta a muro.
- F** Installazione con pareti in cartongesso #96615000.

Esempi per l'installazione con indicazioni delle misure e per le dimensioni delle tubature sono riportati a partire dalla pagina 96. Per il significato dei simboli impiegati si vedano le pagine 12 e 13.

Le quote di montaggio indicate nelle istruzioni di montaggio sono ideali per persone grandi circa 1800 mm e eventualmente vanno adattate. A ciò bisogna fare attenzione, che ad altezza di montaggio cambiati l'altezza minima necessaria indica cambia e che bisogna considerare la modifica delle quote di collegamento.

Suggerimento per l'installazione

Per avvitare i raccordi bloccare l'Box nella morsa come illustrato.

Lavaggio della tubazione

Eeguire il lavaggio della tubazione come suggerisce la normativa DIN 1988 / EN 1717. Indicare sulla copertura del corpo quale alimentazione è collegata a quale tubo di uscita (ad es. acqua fredda con uscita 1 e acqua calda con uscita 2). Nel caso in cui si sia utilizzata una sola uscita, dopo il primo processo di lavaggio la copertura deve essere ruotata di 90° per eseguire il secondo processo di lavaggio.

l'Box in combinazione con Exafill scarico con erogazione al troppo pieno (vedi pagg. 95)

Dati tecnici

Pressione d'uso:	max. 1 MPa
Pressione d'uso consigliata:	0,1 - 0,5 MPa
Pressione di prova:	1,6 MPa
(1 MPa = 10 bar = 147 PSI)	
Temperatura dell'acqua calda:	max. 80°C
Temp. dell'acqua calda consigliata:	65°C
Distanza di raccordo:	G ¾
Raccordi:	fredda a destra - calda a sinistra
Portata a 0,3 MPa:	
Miscelatore vasca/doccia:	31 l/min // 24 l/min
Miscelatore vasca incasso con sicurezza (valv. antiriflusso):	

Miscelatore doccia:	25 l/min // 24 l/min
Termostatico:	32 l/min
Termostatico con rubinetto di arresto:	43 l/min
Termostatico con rubinetto di arresto e deviatore:	26 l/min
Termostatico High Flow:	58 l/min
i/Control:	30 l/min

X

Centro vasca / Centro piatto doccia



Rubinetto di arresto

Y

Valore Y = Dal centro del raccordo a muro al centro della bocca di erogazione vasca diviso 2 (eventualmente adattare alla dimensione delle piastrelle).



Quattro Valvola a quattro vie

Acqua calda

Quattro

Trio arresto/deviatore

Acqua fredda



Trio

Dal • si garantisce la funzionalità.

Bocca di erogazione



In questa zona è necessario un rinforzo della parete.



Chiudere con un tappo l'uscita non utilizzata. [DN 20 3/4"]



Non è possibile utilizzare due utenze in contemporanea.



> 50 l/min

La portata di scarico deve essere superiore a 50 l/min.



Posizionare i tubi alle doccette laterali con una leggera pendenza.



Raindrain

iBox in combinazione con Exafill scarico con erogazione di troppo pieno (vedi pagg. 95)



piacca frontale # 159256000, non contenuto nel volume di fornitura



Exafill

DVGW

Miscelatore vasca incasso con sicurezza (valv. antiriflusso) (vedi pagg. 96)



Miscelatore doccia (vedi pagg. 104, 106, 110, 124)



Miscelatore vasca/doccia (vedi pagg. 98, 102, 114, 116)

Bocca di erogazione (vedi pagg. 102)

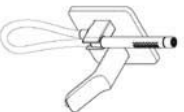



Termostatico
(vedi pagg. 118, 122, 126)



High Flow Termostatico
(vedi pagg. 128 - 138, 142, 144, 150 - 158)



Termostatico con rubinetto di arresto
(vedi pagg. 104, 106, 110, 124)



Termostatico con rubinetto di arresto e deviatore
(vedi pagg. 98, 114, 116, 120)

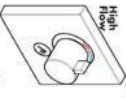

High Flow Termostatico con rubinetto di arresto
(vedi pagg. 140, 146, 148)



Termostatico con rubinetto di arresto
(vedi pagg. 104, 106, 110)



Termostatico con rubinetto di arresto
(vedi pagg. 98, 114, 116, 120)



Termostatico con rubinetto di arresto
(vedi pagg. 100, 112)

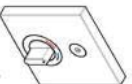

ShowerSelect Miscelatore doccia
(vedi pagg. 104, 106, 110)

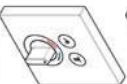

ShowerSelect Miscelatore vasca/
doccia
(vedi pagg. 98, 114, 116, 120)

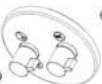

iControl
Rubinetto di arresto e deviatore (vedi
pagg. 150)

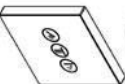

ShowerSelect
3 x rubinetto d'arresto (vedi pagg.
144, 146 - 150, 158)

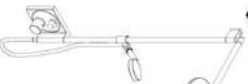

Raindance Showerpipe
(vedi pagg. 108)



Raindance Rainfall 240
(vedi pagg. 140, 142)



Raindance Rainfall 180
(vedi pagg. 154 - 158)



Raindance E 420
(vedi pagg. 150, 152)



Raindance Select E 300
(vedi pagg. 148)

Montaje del cuerpo empotrado

El cuerpo base del iBox universal se puede montar en plano horizontal y vertical. La única excepción se da al instalar el mezclador de baño/ducha con combinación de seguridad integrada. En tal caso, solo la instalación vertical es posible. Instalar el iBox siempre por encima de la bañera ya que, si se rompiera alguna pieza del iBox, el agua estaría contenida.

El iBox universal puede ser utilizado para una grifería baño/ducha o ducha. En combinación con una instalación de baño/ducha / termostato con llave de paso y distribuidor tiene prioridad la salida inferior. En combinación con un monomando ducha debe taparse la salida que no se utiliza.

Grandes diferencias de presión en servicio entre agua frío y agua caliente deben equilibrarse.

Montar el cuerpo de tal manera que el agua caliente esté a la izquierda y el agua frío esté en la derecha.

Profundidad de montaje 80 mm a 108 mm.

Prolongación 25 mm artículo número 13595000

Alargo 22 mm (en caso de pared delgada)

artículo número 13593000 / 13596XXX / 13597XXX / 15597000 / 19427000 / 97407XXX / 98860000

El cuerpo empotrado puede ser colocado según los ejemplos expuestos en las páginas 91 y 92.

A Instalación directamente sobre la pared.

B Instalación sobre la pared. Aquí con soportes de distanciamiento y tornillos de acero de 10.

C Montaje en el sistema portante.

D Instalación en placas murales prefabricados.

E Instalación directa en la pared.

F Instalación con set de guías de fijación #96615000.

A partir de la página 96 puede consultar ejemplos de instalación y dimensionamiento de la conducción. La aclaración de los símbolos utilizados en las páginas 15 y 16.

Las medidas indicadas en las instrucciones de montaje resultan ideales para personas de 1800 mm de altura, por lo que deberán ajustarse siempre que sea necesario. En este sentido, es importante tener en cuenta que, en caso de modificación de la altura de montaje, cambia la altura mínima y habrá que adaptar las medidas de conexión.

Recomendación

Para entrosacar los codos de conexión, fijar el iBox universal mediante un trozo de tubería en un tornillo de banco.

Purga de la tubería

Purgar la instalación según la normativa DIN 1988/ EN 1717. Las flechas en el bloque de purgar indican qué entrada está conectada con qué salida. Si solamente utilizará una salida se ha de girar el bloque de purgar en 90° después del primer proceso de purgar.

iBox universal en combinación con Exafill, vaciador automático con chorro incorporado y rebosadero (ver página 95)

Datos técnicos

Presión en servicio:	max. 1 MPa
Presión recomendada en servicio:	0,1 - 0,5 MPa
Presión de prueba:	1,6 MPa
(1 MPa = 10 bar = 147 PSI)	
Temperatura del agua caliente:	max. 80 °C
Temp. recomendada del agua caliente:	65 °C
Racores excéntricos:	G ¾
Racores excéntricos:	o la derecha frío - o la izquierda caliente

Caudal con 0,3 MPa

Monomando baño/ducha:	31 l/min // 24 l/min
Monomando baño ducha con válvula anti-retorno:	25 l/min // 24 l/min

Monomando ducha:	32 l/min
Termostato:	43 l/min
Termostato con llave de paso:	26 l/min
Termostato con llave de paso y distribuidor:	26 l/min
Termostato High Flow:	58 l/min
iControl:	30 l/min

X Centro de la bañera / Centro la plato de ducha



Llave de paso

Y Medida Y – Desde el centro del racor de empuñe hasta el centro de la boca de entrada a la bañera dividido por 2 (si fuera necesario, adaptar a la trama de los azulejos).

Medida Y – Desde el centro del racor de empuñe hasta el centro de la boca de entrada a la bañera dividido por 2 (si fuera necesario, adaptar a la trama de los azulejos).



Cuatro válvula de 4 vías

Quatro

Agua caliente

Trio llave de paso y distribuidor

Agua fría



Trio



Mínimo • para el correcto funcionamiento.

Caño de bañera



En este sector es necesario un refuerzo del muro.



La salida que no se utiliza debe ser tapada. (DN 20 3/4")



Solo una función posible, no dos funciones al mismo tiempo.



El caudal de desagüe debe ser como mínimo de 50 l/min



Desagüe

Tubería hacia las duchas laterales con pendiente.



Raindrain



Carcaso para purgar #15956000, no incluido en el suministro



¡Box universal en combinación con Exofill, vaciador automático con chorro incorporado y rebosadero (ver página 95)

DVGW



Monomando baño ducha con válvula anti-retorno (ver página 96)



Monomando ducha (ver página 104, 106, 110, 124)



Monomando baño/ducha (ver página 98, 102, 114, 116)

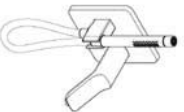

Caño de bañera (ver página 102)



Termostato
(ver página 118, 122, 126)



High Flow Termostato
(ver página 128 - 138, 142, 144,
150 - 158)



Termostato con llave de paso y
distribuidor
(ver página 98, 114, 116, 120)



High Flow Termostato con llave de
paso
(ver página 140, 146, 148)

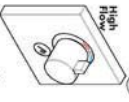

Termostato con llave de paso
(ver página 104, 106, 110)

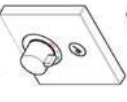

Termostato con llave de paso
(ver página 98, 114, 116, 120)

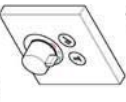

Termostato con llave de paso
(ver página 100, 112)

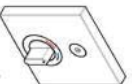

ShowerSelect Monomando ducha
(ver página 104, 106, 110)

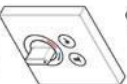

ShowerSelect Monomando baño/
ducha
(ver página 98, 114, 116, 120)

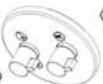

iControl
Llave de paso y distribuidor (ver
página 150)

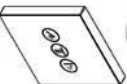

ShowerSelect
3 x Llave de paso (ver página 144,
146 - 150, 158)



Raindance Showerpipe
(ver página 108)



Raindance Rainfall 240
(ver página 140, 142)



Raindance Rainfall 180
(ver página 154 - 158)



Raindance E 420
(ver página 150, 152)



Raindance Select E 300
(ver página 148)

Ruwbouw

Het symmetrische basisgarnituur iBox universeel is zowel horizontaal als verticaal toe te passen. Uitgezonderd bij montage van een badmengkraan met zekerheidscombinatie, deze kan alleen verticaal worden ingebouwd. Bij een defect onderdeel kan mogelijkerwijs water uit de iBox weglagen. Daarom moet de iBox boven het bad gemonteerd worden. Het lekwater wordt dan in het bad afgevoerd!

De iBox is zowel geschikt voor installatie bij het bad als bij de douche. Bij de ééngreeps badmengkraan / thermostaat met stop- en omstelkraan heeft de onderste uitgang voorrang. Bij installatie in de douche moet de onbenodigde uitgang met een blindstop worden afgedicht. Grote drukverschillen tussen de koud- en warmwatertoevoer dienen vermeden te worden.

Basisgarnituur zo inbouwen, dat de aansluiting voor warm water links en voor koud water rechts zit. Inbouwdiepte 80 mm tot 108 mm.

Verlengstuk 25 mm Artikelnummer 13595000
verlengset 22 mm (bij geringe inbouwdiepte)

Artikelnummer 13593000 / 13596XXX / 13597XXX /
15597000 / 19427000 / 97407XXX / 98860000

Het basisgarnituur kan overeenkomstig de situatie ter plaatse worden ingebouwd. Montagevoorbeelden zie pag. 91 en 92.

- A** Installatie voor de wand.
- B** Installatie voor de wand.
- C** Montage op houdersysteem.
- D** Installatie in pletob systemen.
- E** Installatie in de wand.
- F** Installatie met montageset #96615000.

Installatievoorbeelden met massagegevens en capaciteitsdimensionering staan op pagina 96. De toelichting bij de gebruikte symbolen op pagina 18 en 19.

De in de handleiding aangegeven montagematen richten zich op personen van ca. 1800 mm groot en moeten indien nodig aangepast worden. Daarbij moet in acht genomen worden dat bij een gewijzigde montagehoogte ook de minimumhoogte verandert en dat de aansluitmaten overeenkomstig moeten worden aangepast.

Montage tip

Om aansluitingen in te draaien de iBox door middel van een koppeling in de bank Schroef vastzetten.

Spoelen

De complete installatie overeenkomstig DIN 1988/ EN 1717 spoelen. De pinnen op het speelblok geven aan welke ingang met welke uitgang verbonden is, bijv. koud water met uitgang 1 en warm water met uitgang 2. Wanneer slechts 1 uitgang wordt gebruikt, moet men na de eerste spoeling het speelblok 90° draaien.

iBox in combinatie met Exafill badvul-, afvoer- en overloopgarnituur (zie blz. 95)

Technische gegevens

Werkdruk: max.	max. 1 MPa
Aanbevolen werkdruk:	0,1 - 0,5 MPa
Gelast bij:	1,6 MPa
(1 MPa = 10 bar = 147 PSI)	
Temperatuur warm water:	max. 80°C
Aanbevolen warm water temp.:	65°C
Aansluitmaten:	G ¾
Aansluitingen:	koud rechts - warm links
Vrije doorstroom bij 0,3 MPa:	31 l/min // 24 l/min
Badmengkraan met geïntegreerde zekerheidscombinatie:	25 l/min // 24 l/min
Douchemengkraan:	32 l/min
Thermostaat:	43 l/min
Thermostaat met stopkraan:	26 l/min
Thermostaat met stop- en omstelkraan:	26 l/min
Thermostaat High Flow:	58 l/min
Control:	30 l/min

X

Midden bad / Midden Douchebak



Inbouwstopkraan

Y

Maat Y – afstand tussen muuraansluitbochi enbaduitloop hart op hart, gedeeld door 2 (eventueel rekening houden met de wandtegels).



Quattro 4-weg omstelkraan

Quattro

Warm water

Trio stop- en omstelkraan

Koud water



Trio

Vanaf • is het functioneren gegarandeerd.

Beduitloop



In dit bereik is een wandversterking noodzakelijk.

De niet benodigde uitgang moet met een blindstop worden afgedicht. (DN 20 3/4")



Slechts 1 functie mogelijk: geen 2 functies tegelijkertijd.

De afvoer capaciteit moet meer dan 50 l/min bedragen.



Waterleidingen voor zijdouches aflopend plaatsen.



Raindrain



Afvoer

spoelblok kompl. # 15926000, behoort niet tot het leveringspakket

iBox in combinatie met Exfill bodkuf, afvoer- en overloopgarnituur (zie blz. 95)



Exfill

DVGW

Bodemengkraan met geïntegreerde zekerheidscombinatie (zie blz. 96)

Douchemengkraan (zie blz. 104, 106, 110, 124)



Bodemengkraan (zie blz. 98, 102, 114, 116)

Beduitloop (zie blz. 102)

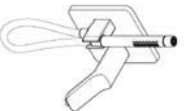

Thermostaat
(zie blz. 118, 122, 126)



High Flow Thermostaat
(zie blz. 128 - 138, 142, 144, 150 - 158)



Thermostaat met stopkraan
(zie blz. 104, 106, 110, 124)



Thermostaat met stop- en omselkroan
(zie blz. 98, 114, 116, 120)



High Flow Thermostaat met stopkraan
(zie blz. 140, 146, 148)

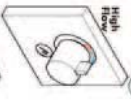

Thermostaat met stopkraan
(zie blz. 104, 106, 110)



Thermostaat met stopkraan
(zie blz. 98, 114, 116, 120)

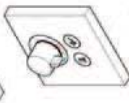

Thermostaat met stopkraan
(zie blz. 100, 112)



ShowerSelect Douchemengkraan
(zie blz. 104, 106, 110)

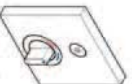

ShowerSelect Bodmengkraan
(zie blz. 98, 114, 116, 120)



iControl
Stop- en omselkroan (zie blz. 150)



ShowerSelect
3 x inbouwstopkranen (zie blz. 144,
146 - 150, 158)

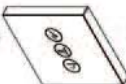

Raindance Showerpep
(zie blz. 108)



Raindance Rainfall 240
(zie blz. 140, 142)



Raindance Rainfall 180
(zie blz. 154 - 158)



Raindance E 420
(zie blz. 150, 152)



Raindance Select E 300
(zie blz. 148)

Råmontage

Iboxens grundrop er universel – kan monteres horisontalt og vertikalt. Undtagelsen er dog ved montering af kar/brusearmaturer med integreret sikkerhedskombination, her er kun den vertikale montering mulig. Da der ved evt. defekt vil komme vand i iboxen, skal denne monteres over karret, således at vandet ledes ned i karret!

Iboxen er egnet til såvel kar- som til bruseinstallation. Ved 1-grebs kararmatur / termostat med afspæringsventil og omskifter er afgang foruden primæragang. Ved bruseinstallation skal den overfløede afgang afproppes.

Større trykforstælle mellem koldt og varmt vand bør udlæsvnes.

Grundkroppen indbygges således, at varmvandsslutningen er til venstre og koldvandsslutningen er til højre.

Monteringsdybde 80 mm til 108 mm.

Forlængersæt 25 mm art. nr. 13595000

Forlænger 22 mm (ved for stor indbygningdybde)

art. nr. 13593000 / 13596XXX / 13597XXX / 13597000 / 19427000 / 97407XXX / 98860000

For monteringseksempler se s. 91 og 92.

- A** Installation på væggen.
- B** Installation på væggen. Her med fleksibel afstandsholder med 10 mm justerbar monteringskrave.
- C** Montering på skinesystemet.
- D** Installation på montageplade.
- E** Installation direkte i væggen.
- F** Installation med monterings-skinesæt #92615000.

Installationseksempler med mål og ledningsdimensioner kan efterlæses fra side 96. Forklaringer til symbolerne findes på side 21 og 22.

Målene i monteringsanvisningen er ideel til personer med en størrelse på 1800 mm og skal i givet fald tilpasses. Herved skal der tages hensyn til, at den mindste højde i tilfælde af en ændret monteringshøjde ændres og at der skal tages hensyn til de ændrede tilslutningsmål.

Monterings-tips

For montering af tilslutningsvinkler, kan Iboxen fastspændes i en skruetvinge ved hjælp af et rørstyrkke.

Gennemskylning

Den komplette installation skal gennemskyldes efter DIN 1988 / EN 1717. Pløene på tegningen viser, hvilke tilgange og afgange der er forbundet med hinanden, f.eks. koldt/vand med afgang 1 og varmt/vand med afgang 2. I tilfælde hvor kun én afgang benyttes, skal skylleblokken drejes 90° efter første gennemskylning.

IBox i kombination med Exafill påfyldnings- og overløbsgarniture (se s. 95)

Tekniske data

Drifttryk:	max. 1 MPa
Anbøtlet drifttryk:	0,1 - 0,5 MPa
Prøvetryk:	1,6 MPa
(1 MPa = 10 bar = 147 PSI)	
Varmtvandstemperatur:	max. 80°C
Anbøtlet varmtvandstemperatur:	65°C
Tilslutningsmål:	G ¾
Tilslutninger:	Koldt højre - varmt venstre
Fri gennemstrømning ved 0,3 MPa:	31 l/min // 24 l/min
Kararmatur med integreret sikkerhedskombination::	25 l/min // 24 l/min
Brusearmaturer:	32 l/min
Termostat:	43 l/min
Termostat med afspæringsventil:	26 l/min
Termostat med afspæringsventil og omskifter:	26 l/min
Termostat High Flow:	58 l/min
iControl:	30 l/min

X

Midt badekar / Midt brusekar



Alspæringsventil

Y

Mål Y = Midt slangeudgang til midt kartud divideret med 2 (evt. tilpas med fuger i fliserne).



Quattro 4-vejs ventil



Varmt vand

Trio dbspæringsventil og omskifter

Koldt vand



Trio

Fra • er funktionen anvendelig.

Kartud



I dette område er en forstærkning af væggen nødvendig!

Alngangen, der ikke benyttes, skal afpropes. (DN 20 ¾")



Det er kun muligt at benytte én funktion ad gangen.

Allebskopocleten skal være mere end 50 l/min.



Vandledningerne til sidebruserne med fold.



> 50 l/min

Alløb



Skylleblok kpl. # 15956000, ikke med i leveringsomfang



Rainrain

!Box i kombination med Exafill pøtylednings- og overløbsgarniture (se s. 95)



Exafill

DVGW



Kararnatur med integreret sikkerhedskombination, (se s. 96)



Brusearmaturer (se s. 104, 106, 110, 124)



Kararnaturer (se s. 98, 102, 114, 116)

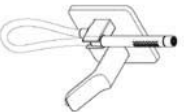

Kartud (se s. 102)



Termostat
(se s. 118, 122, 126)



High Flow Termostat
(se s. 128 - 138, 142, 144, 150-158)



Termostat med afspæringsventil
(se s. 104, 106, 110, 124)



Termostat med afspæringsventil og omskifter
(se s. 98, 114, 116, 120)

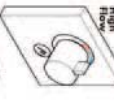

High Flow Termostat med afspæringsventil
(se s. 140, 146, 148)

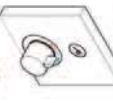

Termostat med afspæringsventil
(se s. 104, 106, 110)

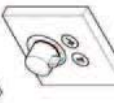

Termostat med afspæringsventil
(se s. 98, 114, 116, 120)



Termostat med afspæringsventil
(se s. 100, 112)



ShowerSelect Brusearranger
(se s. 104, 106, 110)



ShowerSelect Karamander
(se s. 98, 114, 116, 120)



Kontrol
Afspæringsventil og omskifter (se s. 150)

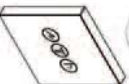

ShowerSelect
3 x Afspæringsventil (se s. 144, 146-150, 158)



Raindance Showerpipe
(se s. 108)



Raindance Rainfall 240
(se s. 140, 142)



Raindance Rainfall 180
(se s. 154 - 158)



Raindance E 420
(se s. 150, 152)

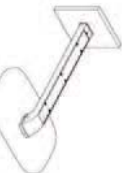

Raindance Select E 300
(se s. 148)

Instalação embutida na parede

O corpo de rotação simétrica pode ser instalado quer na horizontal quer na vertical. A única exceção é ao instalar uma misturadora de banheira/chuveiro com combinação de segurança. Neste caso, apenas é possível uma instalação vertical. Instalar a iBox sempre sobre a banheira. No caso de haver algum defeito nas peças da iBox a água pode fluir para lá.

A iBox é aplicável numa instalação de banheira e de chuveiro. Na misturadora de monobloco para banheira / misturadora termostática com inversor/válvula de corte, a saída inferior é prioritária. Na instalação num chuveiro é necessário vedar a saída desnecessário com um tampo.

Grandes diferenças entre as pressões das águas quente e fria devem ser compensadas.

Instalar o corpo com a ligação para água quente à esquerda e a ligação para a água fria à direita.

Profundidade de montagem 80 mm até 108 mm.

Crescente 25 mm referência 13595000

Crescente 22 mm (quando instalado demonstrado longe da parede)

referência 13593000 / 13596000 / 13597000 / 15597000 / 19427000 / 97407000 / 98860000

O corpo pode, dependendo da construção, ser instalado de diferentes maneiras, ver nas páginas 91 e 92 exemplos de instalação

A Instalação sobre a parede.

B Instalação sobre a parede com colçao ajustáveis de 10 mm.

C Montagem no sistema de suporte.

D Instalação em paredes ocas.

E Instalação em paredes de tijolo.

F Instalação com sel de fixação #96615000.

Exemplos de instalação com indicações dimensionais e dimensionamento das tubagens, podem ser encontrados a partir da página 96. A explicação dos símbolos empregues, encontra-se na página 24 e 25.

As dimensões de montagem indicadas nas instruções de montagem são ideais para passasas com uma altura aprox. 1800 mm e têm que ser eventualmente adaptadas. Neste contexto deve ter-se em atenção que alterações na altura de montagem obrigam a alterações na altura mínima, bem como alterações nas dimensões de ligação.

Conselho para montagem

Para instalar as curvas de ligação na iBox coloque um tubo na iBox e prendo-o num torno.

Purgar as tubagens

Para completar a instalação purgar as tubagens de água quente e da água fria. As setas no corpo de descarga estão a mostrar que entrada está ligada com que saída, por exemplo, água fria com saída 1 e água quente com saída 2. Se apenas estiver em uso uma saída, após a 1ª purgagem o corpo de descarga deve ser rodado cerca de 90°.

iBox em combinação com Exafill com bica e avisador (ver página (ver página 95)

Dados Técnicos

Pressão de funcionamento:	max. 1 MPa
Pressão de func. recomendada:	0,1 - 0,5 MPa
Pressão testado:	1,6 MPa
(1 MPa = 10 bar = 147 PSI)	
Temperatura da água quente:	max. 80 °C
Temp. água quente recomendado:	65 °C
Distância entre eixos:	G ¾
Ligações:	frio à direita - quente à esquerda
Caudal a 0,3 MPa:	
Misturadora de banheira/chuveiro:31 l/min //	24 l/min
Misturadora de banheira/duche com combinação de segurança integrada:	
	25 l/min //
Misturadora de chuveiro:	32 l/min
Misturadora termostática:	43 l/min
Misturadora termostática com válvula de corte: 26 l/min	
Misturadora termostática com inversor/válvula de corte:	
26 l/min	
Misturadora termostática High Flow:	58 l/min
iControl:	30 l/min

X

Meio da banheira / Meio do boste de duche



Torneira de passagem

Y

Medida Y=Centro da curva de ligação até ao centro da bica da banheira dividida por 2 (conjugar com os azulejos, se for o caso).



Quatro válvula de diverção de 4 vias

Água quente

Trio universal inversor/válvula de corte

Água fria



Trio



• A partir deste ponto inicia-se o funcionamento correcto.



Entrada de banheira



Nesta zona é necessário um reforço na parede.

Tamponar a saída não utilizada. (DN 20 3/4")



Apenas uma saída de cada vez, não duas simultaneamente.

Capacidade de escoamento tem que ser superior a 50 l/min.



Instalar os tubos para os chuveiros laterais com ligeira inclinação.



Escoamento

> 50 l/min

Raindrain

Corpo de descarga compl. #15956000, não incluído no volume de fornecimento



!Box em combinação com Exafill com bico e visador (ver página 95)



Exafill

DVGW



Misturadora de banheira/duche com combinação de segurança integrada (ver página 96)



Misturadora de chuveiro (ver página 104, 106, 110, 124)



Misturadora de banheira/chuveiro (ver página 98, 102, 114, 116)

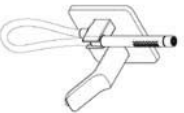

Entrada de banheira (ver página 102)



Misturadora termostática
(ver página 118, 122, 126)



High Flow Misturadora termostática
(ver página 128 - 138, 142, 144,
150 - 158)



Misturadora termostática com válvula
de corte
(ver página 104, 106, 110, 124)



Misturadora termostática com inver-
sor/válvula de corte
(ver página 98, 114, 116, 120)

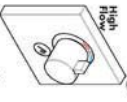

High Flow Misturadora termostática
com válvula de corte
(ver página 140, 146, 148)

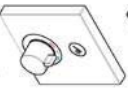

Misturadora termostática com válvula
de corte
(ver página 104, 106, 110)

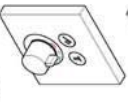

Misturadora termostática com válvula
de corte
(ver página 98, 114, 116, 120)



Misturadora termostática com válvula
de corte
(ver página 100, 112)

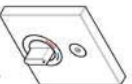

ShowerSelect Misturadora de
chuveiro
(ver página 104, 106, 110)

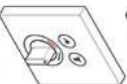

ShowerSelect Misturadora de banhei-
ro/chuveiro
(ver página 98, 114, 116, 120)

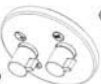

Control
Inversor / válvula de corte (ver página
150)

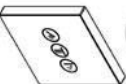

ShowerSelect
3 x Válvula de corte (ver página 144,
146 - 150, 158)

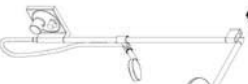

Raindance Showerpipe
(ver página 108)



Raindance Rainfall 240
(ver página 140, 142)



Raindance Rainfall 180
(ver página 154 - 158)



Raindance E 420
(ver página 150, 152)



Raindance Select E 300
(ver página 148)

Montaż przyłączy

Uniwersalny okrągły kształt korpusu iBox pozwala na dowolny sposób montażu i zabudowy, zarówno pionowy jak i poziomy. Z wyjątkiem montażu armatury wannowej ze zintegrowanym systemem zabezpieczającym do wylewki, możliwy jest tylko montaż pionowy. W przypadku uszkodzenia jakichkolwiek elementów przepływającej woda może kapnąć z iBoxa, dlatego też należy zamontować go nad wanną, dzięki czemu woda będzie mogła spływać do wanny.

iBox można wykorzystać zarówno jako baterię wannową jak i jako baterię natryskową. Przy jednoczesnym mieszaniu wannowym / termostat z zaworem odcinającym/przełączającym dolne wyjście ma pierwszeństwo. Przy instalacji przysilnicowej niepotrzebne wyjście musi zostać zamknięte korkiem uszczelniającym.

Znaczne różnice ciśnień na dopływach ciepłej i zimnej wody muszą zostać wyrównane.

Korpus zabudować w taki sposób, aby przyłącza zimnej wody znajdowały się po prawej stronie, a ciepłej po lewej.

Głębokość montażu 80 - 108 mm

Przedłużka 25 mm nr art. 13595000

Rozeta maskująca 22 mm (przy mojej głębokości zabudowy)

nr art. 13593000 / 13596XXX / 13597XXX / 15597000 / 19427000 / 97407XXX / 98860000

Korpus może zostać zabudowany w różnych stadiach budowlanych, przykłady montażowe patrz str. 91 i 92.

A Instalacja na ścianie.

B Instalacja przed ścianą. Na śrubach gwintowanych M10 jako elementy dystansowe.

C Montaż na systemie stelaży.

D Instalacja gotowych płyt montażowych albo gotowych kabin.

E Instalacja w ścianie.

F Instalacja z szynami mocującymi #96615000.

Przykłady instalacji z podaniem ciężarów i rozmiarów przewodów, patrz od strony 96. Wyjaśnienie używanych symboli, patrz strona 27 i 28.

Wymiary montażowe podane w instrukcji montażowej są idealne dla osób o wzroście sięgającym ok. 1800 mm i w razie konieczności należy je dostosować. Należy przy tym zwrócić uwagę na fakt, iż przy zmiennej wysokości montażu zmienia się minimalna wysokość, a także ulegają zmianie wymiary przyłączy.

Wskazówki montażowe

Aby dokręcić przyłącza, zamocować iBox w imadle.

Płukanie

Przeplukac gotową instalację zgodnie z normą. Znaczące szralki jakże doprowadzenie instalacji odpowiada kolejniemu przyłączu np. zimna woda z odpływem 1, ciepła woda z odpływem 2. W przypadku gdy wykonywane jest tylko jedno wyjście, należy obrócić po pierwszym przeplukaniu o 90° przeplukiwany blok.

iBox w kombinacji z odpływem wannowym Exafill posiadającym możliwość napełniania i opróżniania wanny (patrz strona 95)

Dane techniczne

Cisnienie robocze:	maks. 1 MPa
Zalecane ciśnienie robocze:	0,1 - 0,5 MPa
Cisnienie próbne:	1,6 MPa
(1 MPa = 10 bary = 147 PSI)	
Temperatura wody gorącej:	maks. 80 °C
Zalecana temperatura wody gorącej:	65 °C
Wymiary przyłącza:	G ¾
Przyłącza:	Zimno pravo - ciepła lewo
Swobodny przepływ przy 0,3 MPa:	31 l/min // 24 l/min
Mieszacz wannowy:	
Mieszacz wannowy ze zintegrowanym systemem zabezpieczającym do wylewki:	25 l/min // 24 l/min
Mieszacz przysilnicowy:	32 l/min
Termostat:	43 l/min
Termostat z zaworem odcinającym:	26 l/min
Termostat z zaworem odcinającym/przełączającym: 26 l/min	
Termostat High Flow:	58 l/min
iControl:	30 l/min

X Środek wanny / Środek brodzika



Zawór podłynkowy

Y

Wymiary Y – środek mocowania węzła przysznycowego do środka wylewki napełniającej wannę podzielony przez 2 (ewentualnie do posuwoc do układu płytek ceramicznych).



Regulator czterodrożny Quattro

Ciepła woda



Zawór odcinający i regulacyjny Trio

Zimna woda



Universal

Od • możliwe jest funkcjonowanie.

Wylewka wannowa



W tym obszarze konieczne jest wzmocnienie ściany.



Niewykorzystany wylot należy zakorkować dołożonym w dostawie korkiem. [DN 20 3/4"]



Wydatność odpływu musi być wyższa niż 50 l/min.



Odpływ



Przewody doprowadzające do przysznyców bocznych położyć z nachyleniem.



Raindrain



iBox w kombinacji z odpływem wannowym Exafill posiadającym możliwość napełnienia i opróżnienia wanny (patrz strona 95)



Blok puszczący #15956000. Nie jest częścią dostawy

DVGW



Mieszacz wannowy ze zintegrowanym systemem zabezpieczającym do wylewki (patrz strona 96)



Mieszacz przysznycowy (patrz strona 104, 110, 124)



Mieszacz wannowy (patrz strona 98, 102, 114, 116)

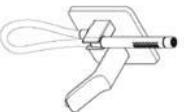

Wylewka wannowa (patrz strona 102)

Termoświat
(patrz strona 118, 122, 126)



High Flow Termoświat
(patrz strona 128 - 138, 142, 144, 150, 158)



Termoświat z zaworem odcinającym
(patrz strona 104, 106, 110, 124)



Termoświat z zaworem odcinającym-prze-
łączającym
(patrz strona 98, 114, 116, 120)



High Flow Termoświat z zaworem
odcinającym
(patrz strona 140, 146, 148)

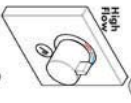

Termoświat z zaworem odcinającym
(patrz strona 104, 106, 110)

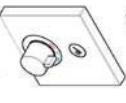

Termoświat z zaworem odcinającym
(patrz strona 98, 114, 116, 120)

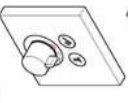

Termoświat z zaworem odcinającym
(patrz strona 100, 112)



ShowerSelect Mieszacz Prysznicowy
(patrz strona 104, 106, 110)

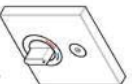

ShowerSelect Mieszacz wannowy
(patrz strona 98, 114, 116, 120)

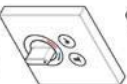

iControl
Zawór odcinający i regulacyjny (patrz
strona 150)



ShowerSelect
3 x Zawór odcinający (patrz strona
144, 146 - 150, 158)

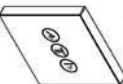

Raindance Showerpipe
(patrz strona 108)



Raindance Rainfall 240
(patrz strona 140, 142)



Raindance Rainfall 180
(patrz strona 154 -
158)



Raindance E 420
(patrz strona 150, 152)



Raindance Select E 300
(patrz strona 148)

Hrubá montáž

Rotačně symetrické základní těleso iBox je univerzálně použitelné, horizontálně i jakož i vertikálně. Nepřítí pro montáž vanové armatury s bezpečnostní kombinací, zde je možná pouze vertikální montáž. Protože v případě závodny funkčních dílů může začít z jednotky iBox vytékat voda, musí být iBox instalován nad vanou, která vytékající vodu odvede.

iBox je vhodný jak pro vanovou, tak i pro sprchovou instalaci. U vanové / termostat s uzavíracím a přeplínacím ventilem jednoruční pákové batérie je prioritní spodní vývod. U sprchové instalace musí být nepoužitý vývod ušněn a zasklepovací zátkou

Je nutné vyrovnat velké rozdíly tlaku mezi přípoji studené a teplé vody.

Základní těleso zabudovat tak, aby se přípoj teplé vody nacházel vlevo a přípoj studené vody vpravo.

Hloubka zabudování 80 mm až 108 mm.

prodloužení 25 mm kat.č. 13595000

prodloužení 22 mm (př malé hloubce zabudování)

kat.č. 13593000 / 13596XXX / 13597XXX /

15597000 / 19427000 / 97407XXX / 98860000

Základní těleso může být namontováno v souladu s požadovanými mříkami na stěbě, příklady montáže viz strana 91 a 92.

A Instalace na stěnu.

B Instalace před stěnu. Zde s vavřabílními rozpěrkami pomocí šroubu M 10.

C Montáž na nosný systém.

D Instalace na montážní panely nebo prefabrikované burky.

E Instalace přímo do stěry.

F Instalace se sodou montážních lišt #96615000.

Příklady instalace s údaji o rozměrech a dimenzování potřebu jsou uvedeny od strany 96. Vysvětlivky k použitým symbolům naleznete na straně 30 a 31.

Montážní rozměry uvedené v návodu pro montáž jsou ideální pro osoby s výškou postavy přibližně 1800 mm a v případě potřeby je nutné je přizpůsobit. Při tom je zapotřebí dbát nato, že se při změněné výšce montáže změni požadovaná minimální výška a že je třeba brát ohled na přípojovací rozměry.

Montážní tip

Abyste bylo možno zatáčet přípojovací tvorky do iBoxu, upněte iBox pomocí častí trubky do světlíku.

Propláchnutí

Kompletní instalaci propláchnout podle normy DIN 1988. Šipka na propláchnovacím bloku ukazuje, kterým proudem je spojen se kterým vedením vývodu, např.

studená voda s vývodem 1 a teplá voda s vývodem 2.

Jeli potřebný pouze jeden vývod, musí být po prvním vypláchnutí propláchnovací blok otočen o 90 stupňů.

iBox v kombinaci s vanovým napouštěním Exafill s odpadovou garniturou (viz strana 95)

Technické údaje

Provozní tlak:	max. 1 MPa
Doporučený provozní tlak:	0,1 - 0,5 MPa
Zkušební tlak:	1,6 MPa
(1 MPa = 10 bar = 147 PSI)	
Teplota horké vody:	max. 80 °C
Doporučená teplota horké vody:	65 °C
Rozteč připojení:	G ¾
Přípoje:	studená vpravo - teplá vlevo
Volný průtok při 0,3 MPa	31 l/min // 24 l/min
Vanová batérie s integrovanou bezpečnostní kombinací:	25 l/min // 24 l/min
Sprchová armatura:	32 l/min
Termostat:	43 l/min
Termostat s uzavíracím ventilem:	26 l/min
Termostat s uzavíracím a přeplínacím ventilem:	26 l/min
Termostat High Flow:	58 l/min
iControl:	30 l/min

X Sříd koupací vany / Sříd sprchové vany



Podomítkový uzavírací ventil

Y

Rozměr Y – vzdálenost sřídů připojení sprchové hadice od sředu vanového napouštění dělítelná 2 (eventuelně přizpůsobit rozměru obkladů).



Quattro

Quattro čtyřcestné přestavování

Teplá voda

Trio Universal - Uzavírací a přepínací ventil

Studená voda



Trio

Od • je zaručená funkce

Vanový vtok



V této oblasti je potřebné zesílení stěny.



Nepoužijte vývod musí být utěsněn zaskle povodí zdíkou. (DN 20 3/4")



Je možné použít pouze jeden spotřebič, ne dva současně.



Odkokový výkon musí být vyšší než 50 l/min.



Vodovodní potrubí pro boční sprchový nainstalovat se spodem.



> 50 l/min

Odkok



výplachový blok kompl. #15956000, není součástí dodávky



Raindrain



Exallit

!Box v kombinaci s vanovým napouštěním Exallit s odpádnutí a přepravovou garniturou (viz strana 95)

DVGW



Vanová baterie s integrovanou bezpečnostní kombinací (viz strana 96)



Sprchová armatura (viz strana 104, 106, 110, 124)



vanová baterie (viz strana 98, 102, 114, 116)

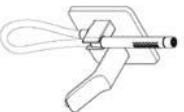

Vanový vtok (viz strana 102)



Termostat
(viz strana 118, 122, 126)



High Flow Termostat
(viz strana 128 - 138, 142, 144,
150 - 158)



Termostat s uzavíracím ventilem
(viz strana 104, 106, 110, 124)



Termostat s uzavíracím a přeplňovacím
ventilem
(viz strana 98, 114, 116, 120)

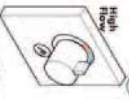

High Flow Termostat s uzavíracím
ventilem
(viz strana 140, 146, 148)

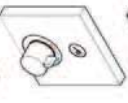

Termostat s uzavíracím ventilem
(viz strana 104, 106, 110)

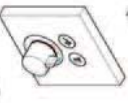

Termostat s uzavíracím ventilem
(viz strana 98, 114, 116, 120)



Termostat s uzavíracím ventilem
(viz strana 100, 112)

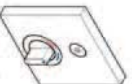

ShowerSelect Sprchová armatura
(viz strana 104, 106, 110)



ShowerSelect vanová baterie
(viz strana 98, 114, 116, 120)



iControl
Uzávěrcí a přeplňovací ventil (viz strana
150)

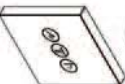

ShowerSelect
3 x uzavírací ventili (viz strana 144,
146 - 150, 158)



Raindance Showerpipe
(viz strana 108)



Raindance Rainfall 240
(viz strana 140, 142)



Raindance Rainfall 180
(viz strana 154 - 158)



Raindance E 420
(viz strana 150, 152)



Raindance Select E 300
(viz strana 148)

Hrubá montáž

Rotačne symetrické základné teleso iBox je univerzálne použiteľné, horizontálne aj vertikálne. Neplatí pri montáži vanové armatúry s bezpečnostnou kombináciou, zde je možné použiť vertikálnu montáž. Pretože v prípade poruchy funkčných častí môže začať z jednotky iBox vytekať voda, musí byť iBox namontovaný nad vaňou, ktorá vytekajúcu vodu odvedie.

iBox je vhodný tak pre vaňovú ako aj sprchovú inštaláciu. Pre jednotučnú pákovú vaňovú batériu / termostatická batéria s uzatváracou jednotkou a prestavovacím ventilom je prioritný spodný vývod. Pre sprchovú inštaláciu musí byť nepoužitý vývod zaslepený zátkou.

Veľké rozdiely v tlaku medzi pripojkami studenej a teplej vody musia byť vyrovnané.

Základné teleso zobudovať tak, aby prívod teplej vody bol vľavo a prívod studenej vody vpravo.

Montážna hĺbka: 80 mm až 108 mm.

Predĺženie 25 mm výrobné číslo 13595000

Predĺženie 22 mm (pri malej montážnej hĺbke).

výrobné číslo 13593000 / 13596XXX / 13597XXX / 15597000 / 19427000 / 97407XXX / 98860000

Základné teleso je montované podľa podmienok na strane podľa príkladov inštalácie vii strana 91 a 92.

A Inštalácia na stenu.

B Inštalácia pred stenu pomocou nastaviteľných 10 mm skrutiek.

C Montáž na nosný systém.

D Inštalácia na montážne dosky hotového domu alebo hotové bunky.

E Inštalácia priamo do steny.

F Inštalácia so sadou montážnych lišt #96615000.

Inštalčné príklady s uvedením rozmerov a výkonov nájdete od strany 96. Vysvetlenie použitých symbolov nájdete na strane 33 a 34.

Montážne rozmery uvedené v návode na montáž sú ideálne pre osoby s výškou postavy približne 1800 mm a v prípade potreby je nutné ich prispôbiť. Pri tom je nutné si uvedomiť, že pri zmenej výške montáže sa mení minimálna výška a je nutné dbať na rozmery rozmiestnenia prípojok.

Montážny tip

Aby sa dali pripojovacie kusy dobre zatiaľ, upne sa iBox pomocou trubkovej narovky do zverátka.

Prepláchnutie

Kompletnú inštaláciu prepláchnuť podľa normy DIN 1988. Šípka na prepláchnovacom bloku ukazuje, ktorý prívod je spojený s ktorým vedením vývodu, napr. prívod studenej vody s vývodom 1, prívod teplej vody s vývodom 2. Ak je použitý len jeden vývod, musí byť prvom prepláchnuť prepláchnovaci blok otočený o 90 stupňov.

iBox kombinovaný s EXAFILL vaňovým napúšťaním s odpadovou a prepádovou garnitúrou (viď strana 95)

Technické údaje

Prevádzkový tlak:	max. 1 MPa
Doporučený prevádzkový tlak:	0,1 - 0,5 MPa
Skúsobný tlak:	1,6 MPa
(1 MPa = 10 bar = 147 PSI)	
Teplota teplej vody:	max. 80°C
Doporučená teplota teplej vody:	65°C
Pripojacie rozmery:	G ¾
Pripoje:	studená vpravo - teplá vľavo
Volný prietok pri 0,3 MPa	31 l/min // 24 l/min
vaňová batéria:	
mešalna batéria za kopalno kadz v vgrajeno varovalno kombinacijo:	25 l/min // 24 l/min
Sprchová batéria:	32 l/min
Termostatická batéria:	43 l/min
Termostatická batéria s uzatváracím ventilom:	26 l/min
Termostatická batéria s uzatváracou jednotkou a prestavovacím ventilom:	26 l/min
Termostatická batéria High Flow:	58 l/min
iControl:	30 l/min

X Stred xane / Stred sprchovej vane



Podmielikový uzatvárací ventil

Y Rozmer Y – vzdialenosť stredu pripojenia sprchovej hadice od stredu vaňového napúšťania deliteľná 2 (prípadne prispôsobíť rozmeru obkladu)



Quattro štvorcové prestavenie

Teplá voda



Quattro

Studená voda



Trio

Trio univerzálny uzatvárací a prestavovací ventil

Od • je zaručená funkcia.



Vaňový vtok

V tejto oblasti je potrebné zosilnenie steny.



Nepoužitý vývod musí byť zastavený zátkou. (DN 20 3/4")



Výkon odtoku musí byť vyšší ako 50 l/min.



Je možné použiť len jeden spotrebič, nie dva súčasne.



> 50 l/min

Odtok



Vodovodné potrubie pre bočné sprchy vypáďovať.



Raindrain



Exofill

iBox kombinovaný s EXAFILL vaňovým napúšťaním s odpadovou a prepádovou garnitúrou [viď strana 95]



Kompletný vypúšťaciaci blok #15956000, nie je súčasťou dodávky

DVGW



mešalica batéria za kopolno kad z vgrajeno varovalno kombinacijo (viď strana 96)



Sprchová batéria (viď strana 104, 106, 110, 124)



vaňová batéria (viď strana 98, 102, 114, 116)

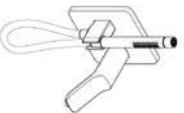

Vaňový vtok (viď strana 102)



Termostatická batéria
(viď strana 118, 122, 126)



High Flow Termostatická batéria
(viď strana 128 – 138, 142, 144,
150 - 158)



Termostatická batéria s uzatváracím
ventilom
(viď strana 104, 106, 110, 124)



Termostatická batéria s uzatváracou
jednotkou a prestavovacím ventilom
(viď strana 98, 114, 116, 120)

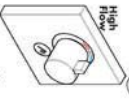

High Flow Termostatická batéria s
uzatváracím ventilom
(viď strana 140, 146, 148)

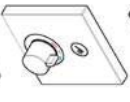

Termostatická batéria s uzatváracím
ventilom
(viď strana 104, 106, 110)

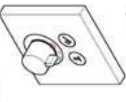

Termostatická batéria s uzatváracím
ventilom
(viď strana 98, 114, 116, 120)



Termostatická batéria s uzatváracím
ventilom
(viď strana 100, 112)

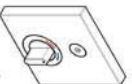

ShowerSelect Sprchová batéria
(viď strana 104, 106, 110)

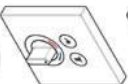

ShowerSelect vaňová batéria
(viď strana 98, 114, 116, 120)



iControl
Uzatvárací a prestavovací ventil (viď
strana 150)

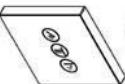

ShowerSelect
3 x uzatvárací ventil (viď strana 144,
146 - 150, 158)



Raindance Showerpipe
(viď strana 108)



Raindance Rainfall 240
(viď strana 140, 142)



Raindance Rainfall 180
(viď strana 154 - 158)



Raindance E 420
(viď strana 150, 152)

Raindance Select E 300
(viď strana 148)

相安装

iBox的旋转对称基体可以作为万能部件使用。在此只能垂直安装。始终在浴缸上侧安装iBox。如果iBox零件即将断裂，水可能从这里流出！

iBox 不仅适用于槽安装。同样也适用于花洒安装。安装单手槽装置/恒温龙头及阀体和分流器单元时，下水口水口优先。安装花洒时，必须使用堵头密封不需要的出水口。

冷热水管间过大的压力差必须予以平衡。

基体安装在热水连接装置左侧和冷水连接装置右侧。

安装深度：80mm至108 mm。

加长 25 mm 商品编号 135955000

加长件22mm（墙壁不够深时）

商品编号 13593000 / 13596XXX / 13597XXX / 15597000 / 19427000 / 97407XXX / 98860000

根据构造的实际情况安装基体。安装范例参见第91页和第 92 页。

- A** 直接墙面安装。
- B** 直接墙面安装，带10 mm可调节的固定柱头螺栓。
- C** 安装在支柱上。
- D** 中空墙壁安装
- E** 砖墙安装
- F** 使用固定组件安装 #96615000。

带数据相管道尺寸的安装实例请从 96 页起查找。所使用符号的说明参见 36 页和 37 页。

本安装说明中所规定的安装尺寸理想用于身高 1800 mm 左右的人士。尺寸可根据需要进行修改。在这种情况下，您必须留意，如果安装高度改变，则花洒到地板的最小高度也随之改变，且必须考虑到连接尺寸的改变。

安装提示

iBox通过管件在台虎钳内处理。这样可以使人连接件。

冲流管系统

按照德国工业标准1988/欧洲标准1717清洗全部安装件。请用手指清洗喷嘴。按流向与该出口导通装置连接。例如：冷水与出口1连接，热水与出口2连接。如果只需要一个出口，那么，在第一个清洗过程后，90°旋转冲流嘴。

iBox与下水部件组合 配备出水组件及溢流组件 (参见第95页)

技术参数

工作压力:	最大 1 MPa
推荐工作压力:	0.1 - 0.5 MPa
测试压强:	1.6 MPa
(1 MPa = 10 bar = 1.47 PSI)	
热水温度:	最大 80°C
推荐热水温度:	65°C
中心距高:	G
连接管径:	左热右冷
0.3 MPa时的流速:	
浴缸-淋浴龙头:	31 升/分钟 // 24 升/分钟
浴缸-淋浴龙头及整体式安全组合:	25 升/分钟 // 24 升/分钟
淋浴龙头:	32 升/分钟
恒温龙头:	43 升/分钟
恒温龙头及阀体单元:	26 升/分钟
恒温龙头及阀体和分流器单元:	26 升/分钟
恒温龙头 High Flow:	58 升/分钟
iControl:	30 升/分钟

X 槽中间 / 中心淋浴盆



截止阀

Quattro 四通转换器

Y

尺寸Y = 软管壁出口弯管的中心至浴盆加水口中心除以2 (匹配瓷砖布置)。



Quattro

通用的三通截止阀和换向阀

热水

冷水



Trio

浴缸出水口

从开始, 正常功能得以保证。



插入不使用的插座。(DN 20 *)

该区域需要一个加固边缘。



只有一项功能。



安装水管, 用于带有梯度的淋浴器。



截止阀

Quattro 四通转换器

Y

尺寸Y = 软管壁出口弯管的中心至浴盆加水口中心除以2 (匹配瓷砖布置)。



Quattro

通用的三通截止阀和换向阀

热水

冷水



Trio

浴缸出水口

从开始, 正常功能得以保证。



插入不使用的插座。(DN 20 *)

该区域需要一个加固边缘。



只有一项功能。



安装水管, 用于带有梯度的淋浴器。



全套清洗端 #15956000, 不在供货范围内



Raindrain

Box与下水部件组合, 配备出水组件及溢流组件 (参见第95页)



排水口

排水功率必须大于 50 l/min.



> 50 l/min

DVGW

浴缸淋浴龙头及整体式安全组合 (参见第页 96)



淋浴龙头: (参见第页 104, 106, 110, 124)



浴缸—淋浴龙头 (参见第页 98, 102, 114, 116)

浴缸出水口 (参见第页 102)

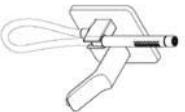



恒温龙头
(参见第页 118, 122, 126)



High Flow 恒温龙头
(参见第页 128, 138, 142, 144,
150 - 158)



恒温龙头及闭锁单元
(参见第页 104, 106, 110, 124)



恒温龙头及闭锁和分流器单元
(参见第页 98, 114, 116, 120)

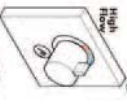

High Flow 恒温龙头及闭锁单元
(参见第页 140, 146, 148)

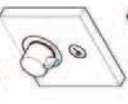

恒温龙头及闭锁单元
(参见第页 104, 106, 110)

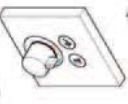

恒温龙头及闭锁单元
(参见第页 98, 114, 116, 120)



恒温龙头及闭锁单元
(参见第页 100, 112)



Shower>Select 淋浴龙头
(参见第页 104, 106, 110)

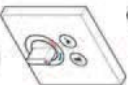

Shower>Select 浴缸—淋浴龙头
(参见第页 98, 114, 116, 120)



Control
截止阀和换向阀 (参见第页 150)

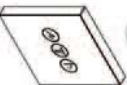

Shower>Select
3 x 停止阀 (参见第页 144, 146 -
150, 158)



Raindance Showerpipe
(参见第页 108)



Raindance Rainfall 240
(参见第页 140, 142)



Raindance Rainfall
180
(参见第页 154 -
158)



Raindance Select E 300
(参见第页 148)

Raindance E 420
(参见第页 150, 152)

Предварительный монтаж

Вращательно-симметричный корпус Вох может использоваться универсально, как горизонтально, так и вертикально. Кроме монтажа арматуры ванны с комбинированным предохранителем здесь возможно только вертикальное установление. Поскольку при неисправности функциональных деталей у Вох может выкачать вода, Вох необходимо монтировать над ванной, чтобы выступающая вода могла стекать в ванну!

Вох предназначен для монтажа как ванн, так и душей. Для однорычужного смесителя для ванны / термостата с запорным и регулировочными клапанами преимущество имеет нижний отвод. При монтаже душа наилучший выход необходимо закрыть пробкой, донного клапа. Перед установкой смесителя необходимо регулировочными кранами выровнять давление холодной и горячей воды при помощи вентилей регулирующих подачу воды в квартиру.

Установите корпус так, чтобы подключение горячей воды находилось слева, а холодной – справа.

Глубина установки от 80 до 108 мм.

Удлинение 25 мм орг. № 13595000

Удлинение 22 мм (при малой глубине установки)

орг. № 13593000 / 13596XXX / 13597XXX /
15597000 / 19427000 / 97407XXX / 98860000

Корпус может монтироваться, согласно условиям

строительств, примеры монтажа см. на стр. 91 и 92.

A варианты установки

В Установка на стене. Здесь с гибким распорным держателем, благодаря винтам 10.

С Монтаж на системе стоек.

D Установка на монтажных шпильках сборных донов или блоках сборных домов.

E монтаж в кирпичную стену

F Установка с помощью комплекта монтажных шин #96615000.

Примеры монтажа с указанием размеров и размеров трубопровода см. на стр. 96. Пояснение к исполнению см. в символах см. на стр. 39 и 40.

Указанные в монтажной инструкции монтажные размеры являются для лиц ростом около 1800 мм. В случае необходимости монтажные размеры следует менять. При этом нужно учесть, что при изменении высоты монтажа меняется также и минимальная высота, а изменение установочных размеров нужно принять во внимание.

Подсказка по монтажу

Для завысивания фитингов закрепите Вох с помощью куска трубы в тисках.

Промывка

Промойте все установленное оборудование, согласно DIN 1988 / EN 1717. Срепки на промывочном блоке показывают, какой вход связан с отводом, напр., холодная вода с отводом 1, а горячая вода - с отводом 2. Если требуется только один отвод, после первой промывки промывочный блок необходимо повернуть на 90°.

Вох в комбинации со впускном ванной ExaFill со сливной и переливной гарнитурой (см. стр. 95)**Технические данные**

Рабочее давление:	не более, 1 МПа
Рекомендуемое рабочее давление:	0,1 - 0,5 МПа
Давление:	1,6 МПа
(1 МПа = 10 bar = 147 PSI)	
Температура горячей воды:	не более, 80°С
Рекомендуемая темп. гор. воды:	65°С
Размеры подключения:	G ¾
Подключение:	холодная справа - горячая слева
Свободное истечение при 0,3 МПа:	
Смеситель ванны:	31 л/мин // 24 л/мин
Смеситель ванны со встроенным комбинированным предохранителем:	25 л/мин // 24 л/мин
Смеситель душа:	32 л/мин
Термостат:	43 л/мин
Термостат с запорным вентилем:	26 л/мин
Термостат с запорным и переключающим вентилем:	
26 л/мин	
Термостат High Flow:	58 л/мин
iControl:	30 л/мин

X середина ванны / Середина душевой ванны



Скрытый вентиль

Y Размер Y – середина дуги подключения шланга, деленная на 2 (или подогнуть пор распр. плитки).



Четырехходовой переключатель Quattro

Quattro

Теплая вода



Трехходовой запорный и переключающий вентиль Trio Universal

Холодная вода

Trio



Водозабор

Гарантированное функционирование при показателях выше *



Ненужный выход необходимо уплотнить с помощью заглушки. (DN 20 3/4")



В этой области требуется укрепление стены.



Слив должен иметь пропускную способность более 50 л/мин.



Возможно использование только одного нагревателя, не двух одновременно.



Слив



Водопроводы для боковых душей прокладывают под наклоном.



Raindrain

!Вок в комбинации со выпуском ванны Exall со сливной и переливной гарнитурой (см. стр. 95)



Exall

ДУШ



Промывочный блок кп. #15926000, не включено в объем поставки!

Смеситель душа (см. стр. 104, 106, 110, 124)



Смеситель ванны со встроенным комбинированным предохранителем (см. стр. 96)



Водозабор (см. стр. 102)

Смеситель ванны (см. стр. 98, 102, 114, 116)

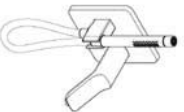



Термостат
(см. стр. 118, 122, 126)



High Flow Термостат
(см. стр. 128 - 138, 142, 144, 150 - 158)



Термостат с запорным венчиком
(см. стр. 104, 106, 110, 124)



Термостат с запорным и переключающим венчиком
(см. стр. 98, 114, 116, 120)

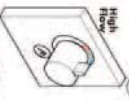

High Flow Термостат с запорным венчиком
(см. стр. 140, 146, 148)

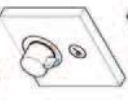

Термостат с запорным венчиком
(см. стр. 104, 106, 110)

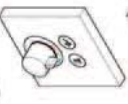

Термостат с запорным венчиком
(см. стр. 98, 114, 116, 120)



Термостат с запорным венчиком
(см. стр. 100, 112)

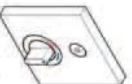

ShowerSelect Смесьтедь душа
(см. стр. 104, 106, 110)



ShowerSelect Смесьтедь ванны
(см. стр. 98, 114, 116, 120)



Control
Запорный и переключающий венчик
(см. стр. 150)

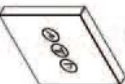

ShowerSelect
3 x Запорный клапан (см. стр. 144, 146 - 150, 158)



Raindance Showerpre
(см. стр. 108)



Raindance Rainfall 240
(см. стр. 140, 142)



Raindance Rainfall 180
(см. стр. 154 - 158)



Raindance E 420
(см. стр. 150, 152)

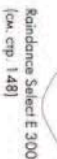

Raindance Select E 300
(см. стр. 148)

Cőszerelés

Az IBox szimmetrikus rotációjú belső szerelékével együtt univerzálisan – vízszintesen és függőlegesen egyaránt – elhelyezhető. A biztonsági szerelvényrel ellátott kádcsaptelep kivételével, itt csak a függőleges beépítés lehetséges. Mivel a működő részek meghibásodásakor víz kerülhet az IBoxra, ezért az IBox-ot a kád fölé kell felszerelni, hogy a kifolyó víz a kádba folyhasson!

Az IBox kádhoz és tusolóhoz egyaránt alkalmas. Egykörös kádcsaptelep / elzáró- és váltószeleppel rendelkező termosztát esetében az első kiállítás az elsődleges.

Zuhanycsaptelep szerelése esetén a használaton kívüli kiállást vakudóval kell lezárni.

A hidegvíz- és a melegvíz-csatlakozások közötti nagy nyomáskülönbséget kikéll egyenlíteni!

Az alaptestet úgy szereljük be, hogy a melegvíz csatlakozása bal oldalra, míg a hidegvíz csatlakozása jobb oldalra kerüljön.

Beépítési mélység: 80 – 108 mm

Hosszabbítás: 25 mm cikkszám 13595000

Hosszabbító készlet: 22 mm (kis beépítési mélység esetén)

cikkszám 13593000 / 13596XXX / 13597XXX / 15597000 / 19427000 / 97407XXX / 98860000

Az alaptestet az építészeti adottságoknak megfelelően szereljük be. A szerelési példákot lásd a 91. és a 92. oldalon.

A Szerelés közvetlenül a falra.

B Törvörös szerkezete való szerelés.

C Tartórendszerre szerelés.

D Szerelés készítőszerszerelepkokra vagy kész cellákra.

E Szerelés falba súlyszetre.

F Szerelés szerelési-szettel #96615000.

Fel szerelési példák méretekkel és vezeték-dimenziókkal az 96 oldalán kezdődően találhatók. A használt szimbólumok magyarázatait az 42 és 43 oldalon találhatók.

A szerelési útmutatóban megadott szerelési méretek kb. 1800 mm testmagasságú személyeknek alkalmasok, és ennek megfelelően dimétrezandók. Itt arra kell ügyelni, hogy az dimétrezett szerelési magasságnál megváltozik a minimális magasság és figyelembe kell venni a csatlakozó méreteinek változását.

Szerelési ötlet

A csatlakozó közdarabok becsavarásához - egy cső segítségével - fogjuk sabta be az IBox-ot.

Átöblítés

Öblítsük át a teljes szerelvényt a DIN 1988 sz. szabvány előírásainak megfelelően. Az öblítőblokkon látható nyílak mutatják, hogy melyik beömös vezeték melyik lefolyó vezetékhez kapcsolódik, így pl. a hidegvíz vezetéke az 1. kiállításhoz és a melegvíz vezetéke a 2. kiállításhoz.

Amennyiben csupán egyetlen kiállításra van szükség, az első öblítési műveletet követően forgrassuk el 90°-kal az öblítő-blokkot.

IBox, valamint Exafill kádöblítő, le- és rúfolyó kombinációja (lásd a 95. oldalon)

Műszaki adatok

Üzemi nyomás:	max. 1 MPa
Állított üzemi nyomás:	0,1 - 0,5 MPa
Nyomáspróba: (1 MPa = 10 bar = 147 PSI)	1,6 MPa
Forróvíz hőmérséklet:	max. 80° C
Forróvíz (javosolt) hőmérséklete:	65° C
Csatlakozási méret:	G $\frac{3}{4}$
Csatlakozási:	hideg jobbra - meleg balra
Szabad átfolyás 0,3 MPa nyomás esetén:	
Kádcsaptelep:	31 l/perc // 24 l/perc
Kádcsaptelep beépített biztonsági egységgel:	25 l/perc // 24 l/perc
Zuhanycsaptelep:	32 l/perc
Termosztát:	43 l/perc
Termosztát elzárószeleppel:	26 l/perc
Termosztát elzáró- és váltószeleppel:	26 l/perc
Termosztát High Flow:	58 l/perc
iControl:	30 l/perc

X A kád közepe / Zuhanyláda közepe



Felső alsó szelep

Y Y méret – a csőcsatlakozó közepétől a kádoltól belülről a közepéig; osztva kettővel (szükség esetén a csempé kiosztásához igazítva).



Quattro négyvutas dióalakú

Melegvíz



Trio univerzális zár- és váltószelep

Hidegvíz



A • -től működik az adott funkció.

Kádbevezetés



Ezen a területen a fal megerősítésére van szükség.

A főleges kimenetel vökdügvővel kell lezárni. (DN 20 3/4")

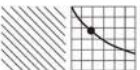

Egyidejűleg csak egy fogyasztót lehet használni, két fogyasztó (zuhanyzósa, oldozózuhanyok) egyszerre nem tud működni.

> 50 l/min

Lefolyó

Az oldalzuhanyokhoz a vízvezetékkel lejtéssel ajánlott beszerelni.



Raindrain

iBox, valamint Exafill kádoltöltés, le- és túlfolyó kombinációja (lásd a 95. oldalon)



Öblítőblokk csatlakozó #15956000, a szállítási egység nem tartalmazza

DVGW

Kádcsaptelep beépített biztonsági

egységgel

(lásd a oldalon 96)



Zuhanycsaptelep

(lásd a oldalon 104, 106, 110, 124)

Kádcsaptelep

(lásd a oldalon 98, 102, 114, 116)

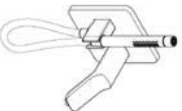

Kádbevezetés

(lásd a oldalon 102)



Termosztár
(lásd a oldalon 118, 122, 126)



High Flow Termosztár
(lásd a oldalon 128 - 138, 142, 144,
150 - 158)



Termosztár elzárószelleppel
(lásd a oldalon 104, 106, 110, 124)



Termosztár elzáró- és váltószelleppel
(lásd a oldalon 98, 114, 116, 120)

High Flow Termosztár elzárószelleppel
(lásd a oldalon 140, 146, 148)

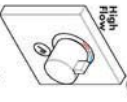

Termosztár elzárószelleppel
(lásd a oldalon 104, 106, 110)

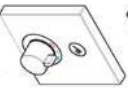

Termosztár elzárószelleppel
(lásd a oldalon 98, 114, 116, 120)

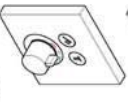

Termosztár elzárószelleppel
(lásd a oldalon 100, 112)

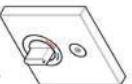

ShowerSelect Zuhanycsepptelep
(lásd a oldalon 104, 106, 110)

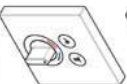

ShowerSelect Kódcsapeptelep
(lásd a oldalon 98, 114, 116, 120)

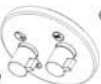

iControl
Záró- és váltószelep (lásd a oldalon
150)

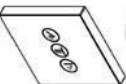

ShowerSelect
3 x Elzárószelep (lásd a oldalon 144,
146 - 150, 158)



Raindance Showerpipe
(lásd a oldalon 108)



Raindance Rainfall 240
(lásd a oldalon 140, 142)



Raindance Rainfall 180
(lásd a oldalon 154
- 158)



Raindance E 420
(lásd a oldalon 150, 152)



Raindance Select E 300
(lásd a oldalon 148)

Raaka-asetennus

Pyrölysymmeirinen iBox:iin peruskappale on yleiskäyttöinen, sen voi asentaa sekä pysty-, että vaakasuoraan. Poikkeuksena sellaisien ammealtahuri, joissa on varmuuskombinaatio, tällöin vain vaakasuora asennus on mahdollinen. Koska iBox:ista voi valua vettä toimintaosien vahingoittuessa, iBox on asennettava ammeen yläpuolelle, jotta valuva vesi pödtsee voluunaan ammeeseen iBox soveltuu sekä amme- että myös suihkuasennukseen. Lähtö 1 on tarkoitettu etupäässä yksikäsi ammesekoittimelle / sulku- ja vaihtoventtiilillä varustetulle termostahtille. Suihkuasennuksessa käyttämähtä pääny lähtö pitää tiivistää sulkuhalpualla.

Suurit paineeroat kylmä- ja kuumovesilinjantöiden välillä on tsastava.

Asenna peruskappale siten, että lamminvesilinjantö tulee vasemmalle ja kylmävesilinjantö aino oikealle puolelle.

Asennussyvyys 80 mm - 108 mm.

Pidemmys 25 mm luotenumero 13595000

Pidemmys 22 mm (pienemmällä asennussyvyydellä)
 luotenumero 13593000 / 13596XXX / 13597XXX /
 15597000 / 19427000 / 97407XXX / 98860000

Peruskappaleen voi asentaa rakennuksen asetoniamen reunahoitujen mukaisesti, katso asennusmerkkejä sivulla 91 ja 92.

A Asennus seinään

B Asennus seinään. Tässä jousitavoa etäisyysdempintä käyttöiden kokosierkeistillä 10 mm ruuveilla.

C Asennus kannattinjärjestelmään

D Asennus valmistalo-asennuslevylle tai valmistaloihin.

E Asennus suoraan seinään.

F Asennus käyttöasenussisko-sarjaa #96615000.

Asennusmerkit mitoitteineen ja purkietoihteineen löytyvät alkaen sivulla 96. Käytettyjen merkkien selitys sivulla 45 ja 46.

Asennusohjeessa annettut asennusmitat sopivat n. 180 cm:n pituiselle henkilöille, ja niitä on tarvittaessa muutettava. Tässä on otettava huomioon, että asennuskorkeuden muutuksessa muuttuu myös vähimmäiskorkeus, ja muutos on otettava huomioon linjantöiden mittoissa.

Asennusvihje

Kiinnitä iBox purkennöikän avulla ruuviipenkkiin, jotta saat kierrettyä liittokappaleet sisään.

Huuhdtelu

Koko asennetta järjestelmää on huuhdteltava DIN 1988 / EN 1717 mukaisesti. Huuhdtelulohkossa olevat suodat ovat mitkä tulot ja liittetyntä mihinkin lähtöön, esim. kylmävesi lähtöön 1 ja lämmintävesi lähtöön 2. Jos tarvitaan vain 1 lähtö, ensimmäisen huuhdtelun jälkeen huuhdtelulohkkoa on kierrätävä 90°.

iBox yhdessä Exafill ammeenttyttöhan varustettuna tyhjennys- ja ylivuoto-varustella (katso sivu 95)

Tekniset tiedot

Käyttöpaino:	maks. 1 MPa
Suosittelu käyttöpaino:	0,1 - 0,5 MPa
Koestuspaino:	1,6 MPa
(1 MPa = 10 bar = 147 PSI)	
Kuuman veden lämpötila:	maks. 80 °C
Kuuman veden suosituspömpötit:	6,5 °C
Liitäntämittat:	G ¾
Liittimet:	kylmä oikealla - kuuma vasemmalla
Vapaa läpivirtaus 0,3 MPa paineella:	31 l/min // 24 l/min
Amme-sekoittaja:	
Amme-sekoittaja integroidulla turvovyhdisteimellä:	25 l/min // 24 l/min
Suihkusekoittaja:	32 l/min
Termostahti:	43 l/min
Termostahti sulkuventtiilillä:	26 l/min
Termostahti sulku- ja vaihtoventtiilillä:	26 l/min
Termostahti High Flow:	58 l/min
Control:	30 l/min

X Ammeen keskus- / Suikkuiltaan keskus



Upotettava venttiili

Y

Mitta Y – etäisyys leikuriliitäntäkaoren keskeltä ammeen huloaukon keskelle jaettuna kahdella (sovitus mahdollisesti laajitusrudukkoon).

4-tiesäätöventtiili



Quattro

Lämmin vesi

Trio -sulku- ja säätöventtiili

Kylmä vesi



Trio



Tämä toiminta on teattuna • alkoen.

Vedenhulo ammeeseen



Tässä kohdassa seinää on vahvistettava

Käytännön lähtötilin on suljettava suikkuilpalla. (DN 20 3/4")



Vain yksi vedenkyttopiste kerrallaan on mahdollista, ei kahla samanaikaisesti.

Poisvirtauksen on oltava enemmän kuin 50l/min.



Vie sivusuuhkujen syöttöputket alaspäin laskevasti.

Veden poisvirtaus



Raindrain



Exafill

iBox yhdessä Exafill ammeentytöhana varustettuna 'yhjennys- ja ylivuotovarustel-la' (katso sivu 95)

DVGW

Ammeeskoiltoja integroidulla turvayhdistelmällä (katso sivu 96)



Suikkueskoiltoja (katso sivu 104, 106, 110, 124)

Ammeeskoiltoja (katso sivu 98, 102, 114, 116)



Vedenhulo ammeeseen (katso sivu 102)

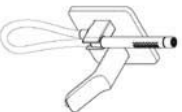



Termostaatti
(katso sivu 118, 122, 126)



High Flow Termostaatti
(katso sivu 128 - 138, 142, 144,
150 - 158)



Termostaatti sulkuventtiilillä
(katso sivu 104, 106, 110, 124)



Termostaatti sulku- ja vahivoventtiilillä
(katso sivu 98, 114, 116, 120)

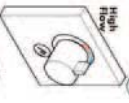

High Flow Termostaatti sulkuventtiilillä
(katso sivu 140, 146, 148)

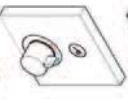

Termostaatti sulkuventtiilillä
(katso sivu 104, 106, 110)

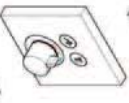

Termostaatti sulkuventtiilillä
(katso sivu 98, 114, 116, 120)



Termostaatti sulkuventtiilillä
(katso sivu 100, 112)



ShowerSelect Suikukehoittaja
(katso sivu 104, 106, 110)



ShowerSelect Armesekoittaja
(katso sivu 98, 114, 116, 120)



iControl
Sulku- ja sätöventtiili (katso sivu 150)

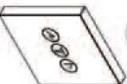

ShowerSelect
3 x Sulkuventtiili (katso sivu 144, 146
- 150, 158)



Raindance Showerpipe
(katso sivu 108)



Raindance Rainfall 240
(katso sivu 140, 142)



Raindance Rainfall 180
(katso sivu 154 - 158)



Raindance E 420
(katso sivu 150, 152)



Raindance Select E 300
(katso sivu 148)

Grundmontering

Den rotationsymmetriska grundkonstruktionen hos iBox är universellt användbar, så väl horisontellt som vertikalt. Detta gäller dock inle för monteringen av kararmatur med säkerhetskombination; här är endast vertikal monterning möjlig. Eftersom vatten kan tränga ut vid iBoxens om funktionsdelar är defekta så måste iBoxen monteras över karell så att det vatten som kommer ut kan rinna ner i karell

iBox är avsedd för såväl kar- som duschinstallation. Till enhandsblandare / termostat med spörr- och omställningsventil används främst det undre ovloppet. Vid installation i dusch måste man sätta en propp i det ovlopp som inle behövs så att detta är tät.

Stora tryckskillnader mellan anslutningarna för varmt och kallt vatten måste utjämnas.

Montera grundkonstruktionen så att varmvattensanslutningen sitter till vänster och kallvattenslutningen till höger.

Monteringsdjup 80 mm till 108 mm.

Förlängning 25 mm artikelnummer 13595000

Förlängning 22 mm (vid liet monteringsdjup)

Artikelnummer 13593000 / 13596XXX / 13597XXX / 15597000 / 19427000 / 97407XXX / 98860000

Grundkonstruktionen monteras enligt de förut sättningar som gäller på platsen, se monteringsexempel på sidor 91 och 92.

A Vögin stallation.

B Vögin stallation. Här med flexibel avståndshållare genom skruvsift storl. 10.

C Montering på stödsystem.

D Installation på monteringsplattor till färdighus eller färdigsektioner.

E Installation direkt i väggen.

F Installation med monteringskänset #96615000.

Du hittar installations exempel med uppgifter om mått och ledningsdimensioner från sidan 96. Förklaringen till de använda symbolerna på sidan 48 och 49.

De monteringsmått som anges i monteringsanvisningen passar 1,80 m långa personer och måste eventuellt anpassas. Det är då viktigt att tänka på att den minsta höjden ändras när monteringshöjden blir en annan och att hänsyn måste tas till de ändrade anslutningsmåtten.

Monteringsstips

Sätt fast iBox i skruvvingen med hjälp av ett rör när anslutningsstycken ska skrivas in.

Spöla

Spöla igenom hela installationen enligt DIN 1988 / EN 1717. Plömma på spöblocket visar vilken inkommande ledning som är ansluten till vilket ovlopp, t.ex. kallvatten till ovlopp 1 och varmvatten till ovlopp 2. Om det bar behövs ett ovlopp måste spöblocket vridas 90° efter första spölingen.

iBox i kombination med ett Exafill karinlopp med från- och överrinningsset (se sidan 95)

Tekniska data

Drifttryck:	max. 1 MPa
Rek. drifttryck:	0,1 - 0,5 MPa
Tryck vid provtryckning: (1 MPa = 10 bar = 1,47 PSI)	1,6 MPa
Varmvattentemperatur:	max. 80 °C
Rek. varmvattentemp.:	65 °C
Anslutningsnått:	G ¾
Anslutningar:	kallt höger - varmt vänster
Fri genomströmning vid 0,3 MPa:	31 l/min // 24 l/min
Karbländare:	
Karbländare med integrerad säkerhetskombination:	25 l/min // 24 l/min
Duschblandare:	32 l/min
Termostat:	43 l/min
Termostat med spörrventil:	26 l/min
Termostat med spörr- och omställningsventil:	26 l/min
Termostat High Flow:	58 l/min
iControl:	30 l/min

X

Mitt på boddar / Mitten av duschkaret



Invändigt ventil

Y

Mitt Y – mitten av slanganslutningskrök till mitten av karntlopp delar med två (ompassa eventuellt till kakelmönstret).



Quattro Fyrvägskomkastare

Quattro

Varmvatten

Trio Universell ovsättningsventil och omkastare

Kallvatten



Trio



Fria • garanteras funktionen.

Badarkran



Stoje zonolje bütinas sienos sutvirtinimos

Det utlopp som inte behövs måste tätas med en blindstopp. (DN 20 3/4")



Endast en enhet möjlig, inte två samtidigt.



Avloppet måste klara mer än 50 l/min.



Drag vottenledningar till sidoduschar med fall.



> 50 l/min

Avlopp



Raindrain



Exofill

iBox i kombination med ett Exofill karntlopp med från- och överrinningsset (se sidan 95)



Spolblock kompl. #15956000, medföljer ej leveransen

DVGW

Karntloppare med integrerad säkerhetskombination (se sidan 96)



Duschblandare (se sidan 104, 106, 110, 124)

Karntloppare (se sidan 98, 102, 114, 116)



Badarkran (se sidan 102)

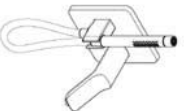

Termostat
(se sidan 118, 122, 126)



High Flow Termostat
(se sidan 128 - 138, 142, 144, 150 - 158)



Termostat med spärrventil
(se sidan 104, 106, 110, 124)



Termostat med spärr- och omställingsventil
(se sidan 98, 114, 116, 120)



High Flow Termostat med spärrventil
(se sidan 140, 146, 148)

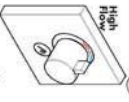

Termostat med spärrventil
(se sidan 104, 106, 110)

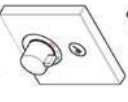

Termostat med spärrventil
(se sidan 98, 114, 116, 120)

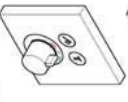

Termostat med spärrventil
(se sidan 100, 112)



ShowersSelect Duschblandare
(se sidan 104, 106, 110)

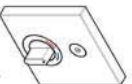

ShowersSelect Karblandare
(se sidan 98, 114, 116, 120)

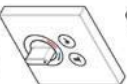

iControl
Avstängningsventil och omkastare (se sidan 150)

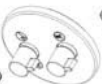

ShowersSelect
3 x Spärrventil (se sidan 144, 146 - 150, 158)

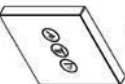

Raindance Showerpipe
(se sidan 108)



Raindance Rainfall 240
(se sidan 140, 142)



Raindance Rainfall 180
(se sidan 154 - 158)

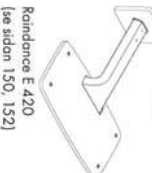

Raindance E 420
(se sidan 150, 152)

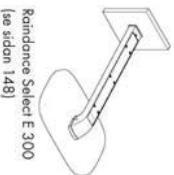

Raindance Select E 300
(se sidan 148)

Bazinis montavimas

Simetriškai beieskančias iBox pagrindą galima įstatyti tiek horizontaliai, tiek vertikaliai. Kai įrengiama vonios armačiūra su apsauginiu rinkiniu, įmontuoti galima tik vertikaliai. "iBox" visada montuojkite virš vonios, kad atšildus problemai su funkcinėmis dalimis, vanduo galėtų į ją nutekėti!

iBox tinka tiek voniai, tiek ir dušui. Viena ranka veldamuo-se maštytuvuose / termostatuose su uždarymo vožtuvais ir skirstytuvais pirmenybė teikiama apotiniam išvadui.

Įrengdami dušą, nereikalingą išvadą sandorai uždenkite kaišiu.

Turi būti išlyginti šalto ir karšto slėgio nelygumai.

Pagrindą sumontuokite taip, kad karšto vandens jungtis būtų kairėje, o šalto - dešinėje.

Montavimo gylys: nuo 80 mm iki 108 mm.

Ilgkis 25 mm Art.Nr. 13595000

Ilgkis 22 mm, esant nepakankamam sienos gyliui:

Art.Nr. 13593000 / 13596XXX / 13597XXX / 15597000 / 19427000 / 97407XXX / 98860000

Pagrindą galite sumontuoti pagal vietos sąlygas, montavimo pavyzdžiai pateikti 91 ir 92 psl.

A Montavimas į sieną.

B Montavimas į sieną su specialiais reguluojamais 10 mm varžtais.

C Montavimas prie laikončios sistemos.

D Montavimas ant montavimo plokščių.

E Montavimas į sieną.

F Montavimas su montavimo rinkiniu #96615000.

Įrengimo pavyzdžiai su nurodytais matmenimis ir vamzdymo dyžiais pateikti 96 puslapyje. Variojų simbolių paaiškinimai pateikti 51 ir 52 puslapiuose.

Montavimo instrukcijoje nurodyti išmatavimai idealiai tinka 1800 mm ūgio žmonėms. Galima keisti aukštį, bet tuomet keičiasi minimalus rekomenduojamas patalpos aukštis ir turi būti atsižvelgta į vandens jungties matmenų pasikeitimą.

Montavimo patarimas

Norėdami įsukti jungiamuosius elementus, vamzdžiu įvirkinkite iBox spaustuvuose.

Išplaukite

Pagal DIN 1988 / EN 1717 išplaukite visą įrangą. Rodykles ant plunomomo bloko rodo, kuriuos įvadus ir išvadu vamzdžius reikia sujungti tarpusavyje, pavyzdžiui, 1 šalto vandens išvadą su 2 karšto vandens išvadu. Jei reikia, lingas tik vienas išvadas, po pirmojo plovimo pasukite plunomomą bloką 90°.

iBox kartu su Exafill vonios čiaupu ir išleidimo bei apsauginės angos rinkiniais (žr. psl. 95)

Techniniai duomenys

Darbinis slėgis:	ne daugiau kaip 1 MPa
Rekomenduojamas slėgis:	0,1 - 0,5 MPa
Bandomasis slėgis:	1,6 MPa
(1 MPa = 10 barų = 147 PSI)	
Karšto vandens temperatūra:	ne daugiau kaip 80 °C
Rekomenduojama karšto vandens temperatūra:	65 °C
Aštimas tarp centri:	G ¾
Prijungimas:	Šaltas vanduo dešinėje, karštas - kairėje
Laisvas vandens protididimas esant 0,3 MPa slėgiui:	31 l/min // 24 l/min
maštytuvos voniai su integruota apsaugos sistema:	25 l/min // 24 l/min
dušo maštytuvas:	32 l/min
Termostatas:	43 l/min
Termostatas su uždarymo vožtuvu:	26 l/min
Termostatas su uždarymo vožtuvu ir skirstytuvu:	26 l/min
Termostatas High Flow:	58 l/min
iControl:	30 l/min

X Vonios viduryje / Dušo padėklų centras



Porčkinis uždarymo vožtuvas

Y

Matmuo Y = atstumas nuo dušo žarnos jungties centro iki čiupo centro, padalinus iš 2 (lei įmanoma, laikykite prie plytelių).



„Quattro“ 4krypčių perjungimas

Šiltas vanduo

Užvarnis ir perjungimo vožtuvas „Trio Universal“

Šaltas vanduo



Nuo • funkcionavimas garantuotas

Vonios įeiga



Šioje zonoje būtinas sienos sutvirtinimas

Nenaudojamą išėjimą užkloti. (DN 20 3/4")



Vienu metu galima tik viena funkcija.



Nulekėjimo našumas turi būti ne mažesnis 50 l/min



Privesiti vamzdičius šoniniams purkštukams.

Nulekėjimas



Plaunamojo bloko jungtis # 159256000, nėra pridėdama

iBox kartu su Exfill vonios čiupu ir išleidimo bei apsauginės angos rinkiniais (žr. psl. 95)

DVGW



maišytuvus voniai su integruota apsaugos sistema (žr. psl. 96)



dušo maišytuvus (žr. psl. 104, 106, 110, 124)



maišytuvus voniai (žr. psl. 98, 102, 114, 116)

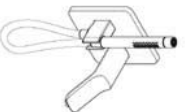

Vonios įeiga (žr. psl. 102)



Termostatas
(žr. psl. 118, 122, 126)



High Flow Termostatas
(žr. psl. 128 - 138, 142, 144, 150 - 158)



Termostatas su uždarymo vožtuvu
(žr. psl. 104, 106, 110, 124)



Termostatas su uždarymo vožtuvu ir skislytuvu
(žr. psl. 98, 114, 116, 120)

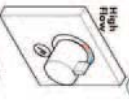

High Flow Termostatas su uždarymo vožtuvu
(žr. psl. 140, 146, 148)

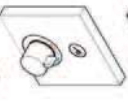

Termostatas su uždarymo vožtuvu
(žr. psl. 104, 106, 110)

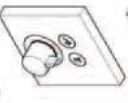

Termostatas su uždarymo vožtuvu
(žr. psl. 98, 114, 116, 120)



Termostatas su uždarymo vožtuvu
(žr. psl. 100, 112)



ShowerSelect dušo matšyvuvas
(žr. psl. 104, 106, 110)



ShowerSelect matšyvuvas voniai
(žr. psl. 98, 114, 116, 120)



Control
Užvarinis ir perjungimo vožtuvas (žr. psl. 150)

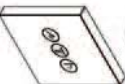

ShowerSelect
3 x Uždarymo vožtuvas (žr. psl. 144, 146 - 150, 158)



Raindance Showerpipe
(žr. psl. 108)



Raindance Rainfall 240
(žr. psl. 140, 142)



Raindance Rainfall 180
(žr. psl. 154 - 158)



Raindance E 420
(žr. psl. 150, 152)



Raindance Select E 300
(žr. psl. 148)

Priprema montaže

Rotacijsko simetrično tijelo jedinice iBox je univerzalno primjenljivo, kako horizontalno tako i vertikalno. Iznimku predstavlja montaža armatura za kade sa sigurnosnom kombinacijom, kod koje je moguća samo vertikalna ugradnja. Budući da kod kvora pojedinih dijelova iz iBox-a može otecati voda, iBox je potrebno instalirati iznad kade kako bi voda mogla otecati u kadu!

iBox je pogodan za ugradnju na tuš kade i kade. Kod jednoručnih mješalica za kade / termostati sa ventilom za zatvaranje i ventilom selektora prioritetan je donji izlaz. Kod instalacije na tuš kadi izlaz koji se ne koristi treba zaštititi čepom.

Velika razlika u pritišku između vruće i hladne vode mora biti izbalansirana.

Montirajte tijelo tako da se priključak tople vode nalazi na lijevoj, a hladne na desnoj strani.

Dubina ugradnje 80 - 108 mm.

Produljenje 25 mm br. Proizvoda 13595000

Produljenje 22 mm (kod manje dubine ugradnje)

br. Proizvoda 13593000 / 13596XXX / 13597XXX / 15597000 / 19427000 / 97407XXX / 98860000

Tijelo se može montirati u skladu s uvjetima koji vladaju na mjestu postavljanja, primjeri montaže mogu se naći na stranicama 91 i 92.

A Direktna instalacija u zid.

B Direktna instalacija u zid sa 10 mm podesivim vijcima

C Montaža na susstav nosača.

D Instalacija u montažne ploče

E Instalacija u zid od cigle.

F Instalacija sa setom instalacijskih udloga #96615000.

Primjeri instalacija s veličinama i dimenzijama vodova mogu se naći od stranice 96 nadalje. Pojašnjenje korištenih simbola nalazi se na stranici 54 i 55.

Montažne dimenzije navedene u uputama za montažu iduće su za osobe visine oko 1800 mm te se prema potrebi moraju prilagoditi konkretnoj visini korisnika. Pri tom valja uzeti u obzir da se u slučaju promjene montaže visine mijenja i minimalna visina koo i da se tada mora uvažiti i promjena priključnih dimenzija.

Savjet u vezi montaže

Za uvrtnje priključnih elemenata iBox treba zategnuti u stepu uz pomoć komada cijevi.

Ispiranje

Kompletnu instalaciju treba ispirati sukladno DIN 1988 / EN 1717. Strelica na bloku prikazuju koji je dovod spojen s kojim odvodom, npr. hladna voda s odvodom 1, a topla voda s odvodom 2. Ukoliko je potreban samo jedan odvod, onda se nakon prvog ispiranja blok mora zakrenuti za 90°.

iBox u kombinaciji s Exafill ispuštom u kadu s odvodnom i prelivnom garniturom (pogledaj stranicu 95)

Tehnički podatci

Najveći dopušteni tlak:	tlak 1 MPa
Preporučeni tlak:	0,1 - 0,5 MPa
Probi tlak:	1,6 MPa
(1 MPa = 10 bar = 147 PSI)	
Temperatura vruće vode:	tlak 80 °C
Preporučena temperatura vruće vode:	65 °C
Raznost od sredine:	G ¾
Spojevi:	hladna desno - topla lijevo
Slobodan protok na 0,3 MPa:	31 l/min // 24 l/min
Mješalica za kadu:	25 l/min // 24 l/min
Mješalica za kadu u ugrađenim sigurnosnim suslovom:	32 l/min
Mješalica tuša:	43 l/min
Termostati:	26 l/min
Termostati sa izolacijskim ventilom:	58 l/min
Termostati sa ventilom za zatvaranje i ventilom selektora:	30 l/min
26 l/min	
Termostat High Flow:	
iControl:	

X Sredina kade / Sredina tuškada  Podzbukni ventil

Y Mjera Y = sredina priključka crijeva do sredine filtera kade podijeljeno sa 2 (eventualno pogoditi rasteru pločica)  Quattro četrverostruki preusmjernič

Topla voda  Trio Universal ventil za zatvaranje i ventil selektora

Hladna voda  Trio

Zajamčena funkcija od • naviše  Ispust u kadu

U ovom je području poštebno ojačanje zida.  Potrebno je ostaviti zatvoren izlaz koji se ne koristi (DN 20 ¾")

Moguće je koristiti samo jedno trošilo, nikako dva istovremeno!  Protok vode mora biti veći od 50 l/min.

Položite vodovodne cijevi za bočni tuš s nagibom  Odvod

 kompletni blok # 15956000, Nije sadržano u isporuci

 Raindrain  Exafill

iBox u kombinaciji s Exafill ispuštom u kadu s odvodnom i preljevnom garniturom (pogledaj stranicu 95)

DVGW  Mješalica za kadu sa ugrađenim sigurnosnim sustavom (pogledaj stranicu 96)  Mješalica tuša (pogledaj stranicu 104, 106, 110, 124)

 Mješalica za kadu (pogledaj stranicu 98, 102, 114, 116)  Ispust u kadu (pogledaj stranicu 102)

Termostati
(pogledaj stranicu 118, 122, 126)



High Flow Termostati
(pogledaj stranicu 128 - 138, 142,
144, 150 - 158)



Termostati sa izolacijskim ventilom
(pogledaj stranicu 104, 106, 110,
124)



Termostati sa ventilom za zatvaranje i
ventilom selektora
(pogledaj stranicu 98, 114, 116, 120)



High Flow Termostati sa izolacijskim
ventilom
(pogledaj stranicu 140, 146, 148)

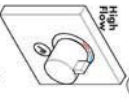

Termostati sa izolacijskim ventilom
(pogledaj stranicu 104, 106, 110)

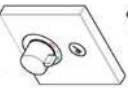

Termostati sa izolacijskim ventilom
(pogledaj stranicu 98, 114, 116, 120)

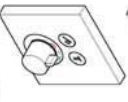

Termostati sa izolacijskim ventilom
(pogledaj stranicu 100, 112)



ShowerSelect Mješalica tuša
(pogledaj stranicu 104, 106, 110)

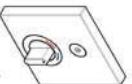

ShowerSelect Mješalica za kudu
(pogledaj stranicu 98, 114, 116, 120)

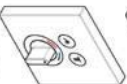

iControl
Ventili za zatvaranje i ventil selektora
(pogledaj stranicu 150)

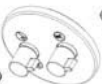

ShowerSelect
3 x zoporni ventili (pogledaj stranicu
144, 146 - 150, 158)

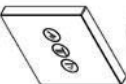

Raindance Showerpipe
(pogledaj stranicu 108)



Raindance Rainfall 240
(pogledaj stranicu 140, 142)



Raindance Rainfall 180
(pogledaj stranicu 154
- 158)



Raindance E 420
(pogledaj stranicu 150, 152) Raindance Select E 300
(pogledaj stranicu 148)

Ham montaj

iBox'un rotasyon simetrik ana gövdesi yatay veya dikey şekilde çok amaçlı kullanılabilir. İstisna: Emniyet kombinasyonu batarya armatürünün montajı sırasında sadece dikey montaj mümkündür. Fonksiyon parçalarının arızalanması durumunda iBox'tan su çıkabileceği için, dışarı çıkan suyun küveye akabilmesi için iBox küveyin üzerine monte edilmelidir.

iBox hem küvet hem de duş testisi için uygundur. Tek elle küvet tipi bataryalarda /Kesme ve diverter/ valfli termostata all çıkış önceliklidir. Duş testisinde, kullanılmıyolan çıkış bir tapuyla izole edilmelidir.

Sıcak ve soğuk su bağlantıları arasında büyük basınç farklılıklarına varsa, bu basınç farklılıklarının dengelemesi gerekir.

Ana gövdeyi, sıcak su bağlantısı solda ve soğuk su bağlantısı sağda olacak şekilde takın.

Montaj derinliği 80 mm ile 108 mm.

Uzatma 25 mm Ürün kodu 13595000

Uzatma 22 mm (montaj derinliği düşüktür)

Ürün kodu 13593000 / 13596XXX / 13597XXX / 15597000 / 19427000 / 97407XXX / 98860000

Ana gövde yapısal koşullara uygun şekilde takılabilir, Montaj örneği: Bkz. Sayfa 91 ve 92.

A Duvara direkt montaj

B Duvara direkt montaj: Burada, esnek mesafe tutucuların ile 10'lü sıkma vidalarını kullanın.

C Tazyıcı sistem üzerine montaj.

D Hazır ev montaj plakaları ya da hazır hücrelere montaj.

E Tuğla duvar Montajı

F Montajı rayı seçtiyse montajı #96615000.

Ölçü verileri ve hat boyutlandırıcı testisat örnekleri Sayfa 96 ile birlikte bulunabilir. Kullanılan simgelerin açıklaması Sayfa 57 ve 58'de.

Montaj kılavuzunda belirtilen montaj ölçüleri, yaklaşık 1.800 mm boyundaki kişiler için idealdir ve gerekirse adapte edilmelidir. Bu sırada, montaj yüksekliğinin değişmesiyle birlikte minimum yüksekliğin de değişimine ve bağlantı ölçülerindeki değişikliklerin göz önüne alınması gerektiğine dikkat edilmelidir.

Montaj önerisi

Bağlantı parçalarını vidalamak için, iBox'u bir boru parçasıyla menemeye sabitleyin.

Yıkama

Tüm testisat DIN 1988 / EN 1717'ye göre yıkayın. Yıkama bloğundaki oklar hangi beslemenin hangi çıkış hattına bağlı olduğunu gösterir. Örn: soğuk su 1, çıkışa ve sıcak su 2. çıkışa. Sadece bir çıkış kullanılıyorsa, birinci yıkama işleminin sonra yıkama bloğu 90° döndürülmelidir.

Çıkış ve taşıma aksesuarlı bir Exafill batarya girişine bağlantılı iBox (Bakınız sayfa 95)

Teknik bilgiler

İşletme basıncı:	özami 1 MPa
Tavsiye edilen işletme basıncı:	0,1 - 0,5 MPa
Kontrol basıncı:	1,6 MPa
(1 MPa = 10 bar = 147 PSI)	
Sıcak su sıcaklığı:	özami 80 °C
Tavsiye edilen su ısı:	65 °C
Bağlantı ölçüleri:	G ¾
Bağlantılar:	soğuk soğ - sıcak sol
0,3 MPa serbest akış:	31 l/dak // 24 l/dak
Küvet miks bataryası:	
Enleğe emniyet kombinasyonu küvet miks bataryası:	25 l/dak // 24 l/dak
Duş miks bataryası:	32 l/dak
Termostat:	43 l/dak
Kesme valfli termostat:	26 l/dak
Kesme ve diverter valfli termostat:	58 l/dak
Termostat High Flow:	58 l/dak
Control:	30 l/dak

Türkçe

X Küvetin ortası / Düş küvetinin ortası



Sivo alı valfi

Y Y – Hortum bağlantı kavşasının ortasından küvet girişinin ortası arasındaki ölçü 2'ye bölünür (gerekiirse foyans bölümlerine odapile edin).



Quattro dört yollu değiştirme

Quattro

Sıcak su

Trio universal kapama ve değiştirme valfi

Soğuk su



Trio

• İden itibaren fonksiyon garanti edilmiştir.

Küvet su girişi



Bu olanda duvarın kalınlığına göre gereklidir.

Kullonilmayan çıkış bir kor topuyla izole edilmektedir. (DN 20 3/4")



Sadece bir tüketici mümkündür, aynı anda iki tüketici mümkün değildir.

Akış kapasitesi 50 l/dak üzerinde olmasıdır.



Yan duvarın su hatlarını eğimli şekilde döşeyin.



Raindrain

Yıkama blogu komple # 159,56000, Teslimat kapsamına dahil değildir



Exofill

Çıkış ve taşıma aksesuarlı bir Exofill banyoya girişliyle bağlantılılı Box (Bakınız sayfa 95)

DVGW



Entegre emniyet kombinasyonu küvet miks banyosu (bakınız sayfa 96)



Düş miks banyosu (bakınız sayfa 104, 106, 110, 124)



Küvet miks banyosu (bakınız sayfa 98, 102, 114, 116)

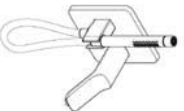

Küvet su girişi (bakınız sayfa 102)

Termostat
[bakınız sayfa 118, 122, 126]



High Flow Termostat
[bakınız sayfa 128 - 138, 142, 144,
150 - 158]



Kesme valfli termostat
[bakınız sayfa 104, 106, 110, 124]



Kesme ve divertör valfli termostat
[bakınız sayfa 98, 114, 116, 120]



High Flow Kesme valfli termostat
[bakınız sayfa 140, 146, 148]

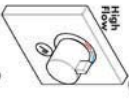

Kesme valfli termostat
[bakınız sayfa 104, 106, 110]

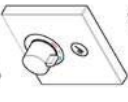

Kesme valfli termostat
[bakınız sayfa 98, 114, 116, 120]

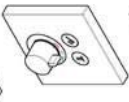

Kesme valfli termostat
[bakınız sayfa 100, 112]



Shower>Select Duş miks bataryası
[bakınız sayfa 104, 106, 110]

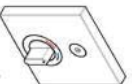

Shower>Select Küvet miks bataryası
[bakınız sayfa 98, 114, 116, 120]

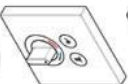

iControl
Kapatma ve değiştirme valfi [bakınız
sayfa 150]



Shower>Select
3 x Kesme valfi [bakınız sayfa 144,
146 - 150, 158]

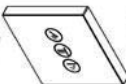

Raindance Showerpipe
[bakınız sayfa 108]



Raindance Rainfall 240
[bakınız sayfa 140, 142]



Raindance Rainfall 180
[bakınız sayfa 154 -
158]



Raindance E 420
[bakınız sayfa 150, 152]

Raindance Select E 300
[bakınız sayfa 148]



Instalare bruță

Partea principală simetric-rotatojonă a iBox-ului poate fi introdusă oricum, atât orizontal cât și vertical. Excepție la montarea robinetului căzii cu combinația de protecție, în acest caz este posibilă numai montarea pe verticală. În cauza posibilității de defectare a componentelor din iBox, montați instalația iBox deasupra căzii pentru ca apa scursă să se evacueze prin cadă.

Cuția iBox este corespunzătoare atât pentru instalarea cadelor căi și a dusurilor. În cazul amestecătorului monomomental pentru cadă / termostat cu venil de închidere și valvă comutator, este prioritară ieșirea inferioară. La instalarea dusului, ieșirea netăcită trebuie etansată cu o garnitură de etansare.

Diferențele de presiune mari între alimentarea cu apă rece și apă caldă trebuie echilibrate.

Corpul de bază este astfel construit încât racordul pentru apa caldă se află în partea stângă, iar cel pentru apă rece, în dreapta.

Adâncime de montare 80 - 108 mm

Prelungitor 25 mm Nr. produs 13595000

Prelungitor 22 mm (în cazul montării la adâncime mică)

Nr. produs 13593000 / 13596XXX / 13597XXX / 15597000 / 19427000 / 97407XXX / 98860000

Corpul de bază se poate monta în funcție de condițiile existente, ca exemplu de montare, vedeți pagina 91 și 92.

A Montare pe perete.

B Montare pe perete. Cu distanțieri flexibili și file filetate de 10 mm cu diblu.

C Montare pe sistem de susținere.

D Montare pe plăci de montare prefabricate sau celule prefabricate.

E Montare direct pe perete.

F Montare cu set de șine de montare #96615000.

Exemple de montaj cu specificații referitoare la dimensiuni și capacitate se găsesc începând de la pagina 96. Explicațiile simbolurilor utilizate se găsesc la pagina 60 și 61.

Dimensiunile de montare din instrucțiunile de montare sunt ideale pentru persoane cu o înălțime de cca. 1800 mm și trebuie modificate dacă este cazul. Aici trebuie să țineți cont de modificarea înălțimii de montare, deoarece în acest caz se va modifica și înălțimea minimă de montare și astfel trebuie modificate toate dimensiunile de racordare.

Indicații pentru montaj

Pentru înșurubarea piesei de racordare, cuția iBox este prevăzută cu o piesă tubulară strănsă în locașul filetat.

Clătire

Toată instalația se spală în conformitate prevederile DIN 1988 / EN 1717. Șegilele de pe blocul de spălare, arată cum se face racordarea la conducta de ieșire, spre apă rece cu ieșirea 1 și apă caldă cu ieșirea 2. În cazul în care este utilizată numai o ieșire, după prima spălare blocul de spălare trebuie rotit cu 90°.

Cuție iBox în combinație cu Exafill pe intrarea în cadă, cu un set pentru evacuare și deversare. (vezi pag. 95)

Date tehnice

Presiune de funcționare:	max. 1 MPa
Presiune de funcționare recomandată:	0,1 - 0,5 MPa
Presiune de verificare:	1,6 MPa
(1 MPa = 10 bar = 147 PSI)	
Temperatura apei calde:	max. 80°C
Temperatura recomandată a apei calde:	65°C
Interax racorduri:	G ¾
Racorduri:	rece - dreapta / cald - stânga
Debit cu curgere liberă la 0,3 MPa:	31 l/min // 24 l/min
baterie pentru cadă de baie:	24 l/min
Baterie pentru cadă de baie cu combinație de siguranță integrată:	25 l/min // 24 l/min

Baterie dur:	32 l/min
Termostat:	43 l/min
Termostat cu venil de închidere:	26 l/min
Termostat cu venil de închidere și valvă comutator:	26 l/min

Termostat High Flow:	58 l/min
Control:	30 l/min

X Cadă de baie în mijloc / În mijlocul căzii de dus



Ventil montat sub tencuială

Y Dimensiune Y – distanța între mijlocul racordului pentru furcă și intrare cadă împărțită la doi (eventual potrivit la suprațoșa tencuiei!).



Quattro valvă de inversare cu patru căi

Apă caldă



Trio valvă de închidere și de inversare universală

Apă rece



Începând de la • funcționarea este garantată.



Gură de admisiune

În această zonă este nevoie de întărire peretelui.



Racordurile neutilizate trebuie acoperite cu dop etanș. (DN 20 3/4")



Capacitatea de evacuare trebuie să fie mai mare de 50 l/min.

Montați conductele de apă inclinate (în cădere) pentru dușurile laterale.



Deversor



Compleți spălare #15956000, nu este inclus în setul livrat



Raindrain

Cutie IBox în combinație cu Exafill pe intrarea în cadă, cu un set pentru evacuare și deversare. (vezi pag. 95)

DVGW



Baterie pentru cadă de baie cu combinație de siguranță integrată (vezi pag. 96)



Baterie dis (vezi pag. 104, 106, 110, 124)



Baterie pentru cadă de baie (vezi pag. 98, 102, 114, 116)

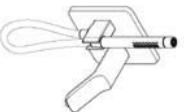

Gură de admisiune (vezi pag. 102)



Termostat
(vezi pag. 118, 122, 126)



High Flow Termostat
(vezi pag. 128 - 138, 142, 144,
150 - 158)



Termostat cu ventil de închidere și
valvă comutator
(vezi pag. 98, 114, 116, 120)



High Flow Termostat cu ventil de
închidere
(vezi pag. 140, 146, 148)

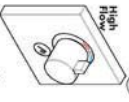

Termostat cu ventil de închidere
(vezi pag. 104, 106, 110)



Termostat cu ventil de închidere
(vezi pag. 98, 114, 116, 120)

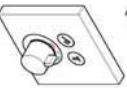

Termostat cu ventil de închidere
(vezi pag. 100, 112)

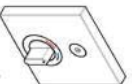

ShowerSelect Baterie dus
(vezi pag. 104, 106, 110)

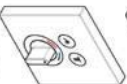

ShowerSelect baterie pentru codă de
baine
(vezi pag. 98, 114, 116, 120)

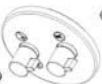

iControl
Valvă de închidere și de inversare
(vezi pag. 150)

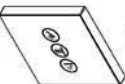

ShowerSelect
3 x Venili de închidere (vezi pag. 144,
146 - 150, 158)



Raindance Showerpipe
(vezi pag. 108)



Raindance Rainfall 240
(vezi pag. 140, 142)



Raindance Rainfall 180
(vezi pag. 154 - 158)

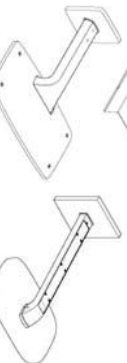

Raindance E 420
(vezi pag. 150, 152)

Raindance Select E 300
(vezi pag. 148)

Εγκατάσταση

Το συμπιεστικό σώμα περιτορισφής του iBox μπορεί να Χρησιμοποιηθεί παντού, οριζόντια και κατακόρυφα. Εξαιρέτως η σωληρομόλωση της μηχανικής μονιάρας, με συνδυασμό ασφαλείας, εδώ είναι έπικτη μόνο η κατακόρυφη εγκατάσταση. Σε περίπτωση βλάβης των λειτουργικών τμημάτων, μπορεί να εξερχεται νερό από το iBox, και θα πρέπει η μονάδα iBox να σωληρολόγηθεί πάνω από την μονιάδα, προκειμένου το εξερχόμενο νερό να πέσει μέσα στην μονιάδα στην περίπτωση αυτή.

Το iBox είναι κατάλληλο για εγκατάσταση τόσο σε μηχανικές όσο και σε γρούζιές. Σε αναμικτήρες μονιάρας με μία λαβή / Βερμουστίες με βαλβίδα έκτοισματος και εκτροπή, προτεινόμενο έχει η κάτω εξογυγή. Σε εγκατάσταση σε ντουζιέρες η εξογυγή που δόν θα χρησιμοποιηθεί θα πρέπει να τοπώνεται με τόπο.

Οι διαφορές της πίεσης μεταξύ της σύνδεσης κρύου και ζεστού νερού θα πρέπει να αντισοθμίζονται.

Τοποθετήστε τη βασική εγκατάσταση έτσι ώστε η σύνδεση ζεστού νερού να βρίσκεται οριζοτάρα και του ψυχρού δάξια.

Βάθος τοποθέτησης 80 -108 mm.

Επιμήκυνση 25 mm αρ. τίδους 13595000

Σωλήνος επιμήκυνσης 22 mm (σε μειωμένο βάθος τοποθέτησης)

αρ. τίδους 13593000 / 13596XXX / 13597XXX / 15597000 / 19427000 / 97407XXX / 98860000

Η βασική εγκατάσταση μπορεί να τοποθετηθεί σύμφωνα με τα δαδομένο του χάρου, παραδείγματα εγκατάστασης βλ.πίνα σάξδα 91 και 92.

A Επιτοχη τοποθέτηση

B Επιτοχη εγκατάσταση, Χρησιμοποήστε 1 Όδρες βίδες κορυφή με εύκαμπτο στηρήγισα.

C Σωληρολόγηση επί κέροντος σωτήγματος.

D Εγκατάσταση σε ηροκατασκευασμένες συνδέες ή σε ηροκατ κεία.

E Εγκατάσταση απευθείας στον τοίχο

F Εγκατάσταση με σετ οδηγιοροχών σωληρολόγησης #96615000.

Παραδείγματα εγκατάστασης με διαστάσεις και διασωληρολόγηση των σωλήνων θα βρείτε από τη σάξδα 96.

Επέξηγηση των Χρησιμοποούμενων εκονών θα βρείτε στη σάξδα 63 και 64.

Οι διαστάσεις που αναφέρονται στις οδηγίες σωληρολόγησης είναι ιδονικές για ότομα με ύψος ηηρ. 1800 mm και πρέπει, εάν Χρειοστεί, να ηροσαρμωσούν. Στη φάση αυτή προσεξτεί ότι με την αλλαγή του ύψους σωληρολόγησης ηροποποιείται και το απορρομένο λάξιστο ύψος, οπότε θα ηροκύψει αλλαγή και στις διαστάσεις σύνδεσης.

Συμβουλή για την εγκατάσταση

Για να βιξώστε ηηρ.όχο σύνδεσης, σφίξτε το iBox με ένα ηηρ.όχο σωλήνος στη μέγγενη.

Καθαρισμός

Επιλέντε όλη την εγκατάσταση σύμφωνα με το DIN 1988 / EN 1717. Τα βίλα στο ηηρ.όχο ξημάξιστος.

δείχουν ποια ηροοχη συνδέεται με ποιο σωλήνος εξέδοου, η.χ. κρύο νερό με εξέδοο 1 και ζεστό νερό με εξέδοο 2.

Εάν Χρειοξείται μόνο μια εξέδοος, ηηρ.όχο ηηρ.όχο διαδοκία ξημάξιστος, το ηηρ.όχο ξημάξιστος πρέπει να γυρoίσει κατά 90°

iBox σε συνδυασμό με τίσοδο νερού μπιονίρας Exafill με απορηή και ξο-ηηξισμό υπερχείλισης [βλ. σάξδα 95]

Τεχνικά Χαρακτηηριστικά

Ληροοχη πίεσης:	έως 1 MPa
Συνιστώμενη Ληροοχη πίεσης:	0,1 - 0,5 MPa
Πίεση αέξγου:	1,6 MPa
(1 MPa = 10 bar = 147 PSI)	
Θηρμωκρασία ζεστού νερού:	έως 80° C
Συνιστώμενη Θηρμωκρασία ζεστού νερού:	65° C
Διαστάσεις σύνδεσης:	G ¾
Συνδέσεις:	κρύο δάξια - ζεστό οριζοτάρα
Εκείθρη ηοή στο 0,3 MPa:	31 l/min // 24 l/min
Μητορία μπιονίρας:	
Μητορία μπιονίρας με ενσωματωμένο συνδυασμό ασφαλείας:	25 l/min // 24 l/min

Μητορία (μεικτήρα) κατονοησήςρα: 32 l/min

Θηρμωσήςρα: 43 l/min















Θηρμωσήςρα με βαλβίδα έκτοισματος: 26 l/min

Θηρμωσήςρα με βαλβίδα έκτοισματος και εκτροής: 26 l/min

Θηρμωσήςρα High Flow:

iControl: 58 l/min
30 l/min

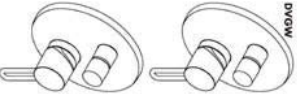
ΕΛΛΗΝΙΚά

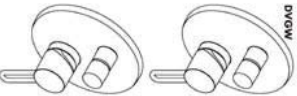
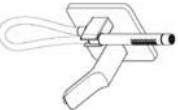
X	Κίτρινο μπινιέρσις / Μίσον της βινιούσις-ρος		Χαμηλή βαλβίδα
Y	Μέγεθος X – από το μέσον του τμήου ονόμευσις του εινωσιμίου οαλήσις έως το μέσον της εσόμευσις της μινιούσις, δύο του 2 (αδόμευσις να ηρίσις να ηρισσοημίσσις σσις πόσιςσις των ηρισόμευσις).		Quattro
	Zιστό νερού		Trio
	Κρύο νερό		Trio
	Αυτή η λειτουργία διασφαλίζει από το σσημίο κι έπσις		Εισοδος νερού σσις μινιούσις
	Σις αυτήν την ηρισσοήτι είναι σσιςποηήσις μία εινωσιμίου του τμήου.		Το ηριστό σσημίο εξόμευσις ηρίσις να σσιςγονοσιηόμευσις με ένα τμήο ηήσις. [DN 20 3/4"]
	Μόνο ένας χρήσις, όχι δύο τσιςτμήουσις		Η σσιςγετυσιική ικόμευσις της βαλβίδος εηρισίς ηρίσις να υπερίσιςσις τα 1/min.
	Επισσιςσιςσις τους σσιςνοήσις νερού του κασιςσιςσιςσις σσημίοσις με κίσιςσις.		Βαλβίδα εηρισίς
	Μηλοκ ζήσιςμίσσις, κοησις #1 59 56 000, δεν ηηρισόμευσις σσιςσις ηρισόμευσις		Exafill
DVGW	Μησιςσις μινιούσις με εινωσιμίσσις σσιςνοήσις οαλήσις (βλ. Σιςίσις 96)		Μησιςσις (μικίςσις) κασιςσιςσιςσις (βλ. Σιςίσις 104, 106, 110, 124)
	Μησιςσις μινιούσις (βλ. Σιςίσις 98, 102, 114, 116)		Εισοδος νερού σσις μινιούσις (βλ. Σιςίσις 102)

Θερμοστάτης
(βλ. Σελίδα 118, 122, 126)



High Flow Θερμοστάτης
(βλ. Σελίδα 128 - 138, 142, 144,
150 - 158)



Θερμοστάτης με βαλβίδα κλείσιματος
(βλ. Σελίδα 104, 106, 110, 124)



Θερμοστάτης με βαλβίδα κλείσιματος
και κτηρητής
(βλ. Σελίδα 98, 114, 116, 120)



High Flow Θερμοστάτης με βαλβίδα
κλείσιματος
(βλ. Σελίδα 140, 146, 148)

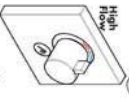

Θερμοστάτης με βαλβίδα κλείσιματος
(βλ. Σελίδα 104, 106, 110)



Θερμοστάτης με βαλβίδα κλείσιματος
(βλ. Σελίδα 98, 114, 116, 120)

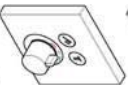

Θερμοστάτης με βαλβίδα κλείσιματος
(βλ. Σελίδα 100, 112)

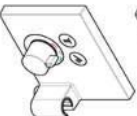

ShowerSelect Μπαρμπα (μετρική)
κατανομήρα
(βλ. Σελίδα 104, 106, 110)

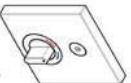

ShowerSelect Μπαρμπα μινιέρας
(βλ. Σελίδα 98, 114, 116, 120)

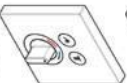

iControl
Βαλβίδα κλείσιματος και κτηρητής (βλ.
Σελίδα 150)

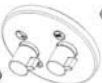

ShowerSelect
3 x Βαλβίδα κλείσιματος (βλ. Σελίδα
144, 146 - 150, 158)

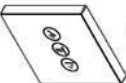

Raindance Showerpipe
(βλ. Σελίδα 108)



Raindance Rainfall 240
(βλ. Σελίδα 140, 142)



Raindance Rainfall 180
(βλ. Σελίδα 154 - 158)

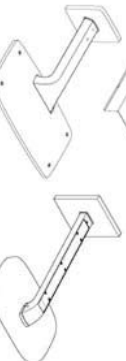

Raindance E 420
(βλ. Σελίδα 150, 152)

Raindance Select E 300
(βλ. Σελίδα 148)

Surova montaža

Rotacijsko simetrično osnovno telo valja iBox je univerzalno uporabljivo, tako vodoravno kot tudi navpično. Izgleda je le montažo armature za kopalno kad z zaščitnim kompletom, kjer je možno le navpična vgradnja. Pri okvri delov iBoxa lahko pride do izteka vode, zato iBox montiramo nad kado. Tako lahko voda odteka v kadi

iBox je primeren tako za instalacije za kopalne kadi kot tudi za prho. Pri enoročnih baterijah za kopalno kad / termostatu z zapornim in preklonim ventilom ima prednost spodnji odvod. Pri instalaciji prhe je treba neuporablen odvod zatesniti s čepom.

Velike razlike v tlaku med priključkom za mrzlo in priključkom za toplo vodo je potrebno izravnati.

Osnovno telo vgradite tako, da se priključek za toplo vodo nahaja na levi, priključek za hladno vodo pa na desni strani.

Globina vgradnje 80 do 108 mm

Podaljšek 25 mm številka artikla 13595000

Podaljšek 22 mm (če zid ni dovolj globok)

Številka artikla 13593000 / 13596XXX / 13597XXX / 15597000 / 19427000 / 97407XXX / 988600000

Osnovno telo se lahko montira ustrezno gradbenim pogojem, montažne primere glejte na strani 91 in 92.

A Montaža na steno

B Montaža na steno. Tukaj z upogljivim distančnikom in 10-milimetrskimi vijaki.

C Montaža na nosilnem sistemu.

D Montaža na montažne plošče

E Montaža direktno v steno

F Montaža s pritrdilnim kompletom #96615000.

Instalacijske primere z navedbami mer in dimenzioniranja cevi najdete od strani 96 dalje. Razlage uporabljajte nih simbolov na straneh 66 in 67.

V navodilu za montažo navedene mere so idealne za osebe, visoke pribl. 1800 mm, in jih je treba po potrebi prilagoditi. Pri tem morate pozni na to, da se pri spremeni montajni višini spremeni tudi minimalna višina in je treba upoštevati spremembo priključnih mer.

Nasvet za montažo

Za uvijte priključnih kosov iBox s pomočjo kosa cevi vpiňte in primetež.

Izpiranje

Kompletno instalacijo splaknite v skladu z DIN 1988 / EN 1717. Puščice na ventilu za vodo kažete, kateri odvod je povezan s katerim odvodom, npr. mrzlo vodo z odvodom 1 in toplu vodo z odvodom 2. Če je potreben le en odvod, se mora po prvem splakovanju ventil za vodo obrniti za 90°.

iBox v kombinaciji z Exafill dovodom za kopalno kad z odtočno in pretočno garnituro (glejte stran 95)

Tehnični podatki

Delovni tlak:	maks. 1 MPa
Priporočeni delovni tlak:	0,1 - 0,5 MPa
Prekusni tlak:	1,6 MPa
(1 MPa = 10 bar = 147 PSI)	
Temperatura tople vode:	maks. 80 °C
Priporočena temperatura tople vode:	65 °C
Razdalja od sredine:	G ¾
Priključki:	mrzla desno - topla levo
Prosti pretok pri 0,3 MPa:	31 l/min // 24 l/min
Mešalna baterija za kadi:	
Mešalna baterija za kad z vgrajeno varnostno kombinacijo:	25 l/min // 24 l/min
Mešalna baterija za prho:	32 l/min
Termostat:	43 l/min
Termostat z zapornim ventilom:	26 l/min
Termostat z zapornim in preklonim ventilom:	26 l/min
Termostat High Flow:	58 l/min
iControl:	30 l/min

X

Sredina kopalne kadi / Sredina pršne kadi



Podometni ventili

Y

Mera Y – sredina loka priključka za cev do sredine dovoka v kadi deljeno z 2 (morebiti prilagoditi vzorcu ploščic)



Quattro ultripolna prestavitel



Topla voda

Trio Universal zoporni in preklopni ventili

Mrzla voda



Od • je delovanje zagotovljeno.

Vlak v kadi



V tem območju je potrebno ojačanje stene.



Izhod, ki ga ne potrebujete, zatesnite s čepom. (DN 20 3/4")



Mogoč je samo en uporabnik, ne dva istočasno.



Odlična kapačletamora znošati več kot 50 l/min.



Položite vodovodne cevi za stranske šobe z naklonom.



Odlok



Ventil za vodo, kpl. #15956000, NI vključeno



iBox v kombinaciji z Exatill dovodom za kopalno kadi z odlično in preločno garnituro (glejte stran 95)

DVGW



Mešalna baterija za kadi z vgrajeno varnostno kombinacijo (glejte stran 96)



Mešalna baterija za prho (glejte stran 104, 106, 110, 124)



Mešalna baterija za kadi (glejte stran 98, 102, 114, 116)

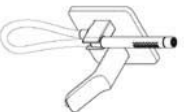

Vlak v kadi (glejte stran 102)

Termostati
(glejte stran 118, 122, 126)



High Flow Termostati
(glejte stran 128 – 138, 142, 144,
150 - 158)



Termostati z zapornim ventilom
(glejte stran 104, 106, 110, 124)



Termostati z zapornim in preklopnim
ventilom
(glejte stran 98, 114, 116, 120)



High Flow Termostati z zapornim
ventilom
(glejte stran 140, 146, 148)

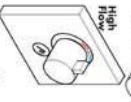

Termostati z zapornim ventilom
(glejte stran 104, 106, 110)

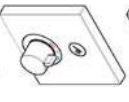

Termostati z zapornim ventilom
(glejte stran 98, 114, 116, 120)

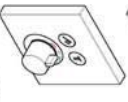

Termostati z zapornim ventilom
(glejte stran 100, 112)



ShowerSelect Mešalna baterija za
prho
(glejte stran 104, 106, 110)

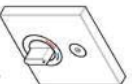

ShowerSelect Mešalna baterija za
kad
(glejte stran 98, 114, 116, 120)

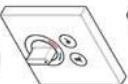

iControl
Zaporni in preklopnii ventil (glejte stran
150)



ShowerSelect
3 x Zaporni ventili (glejte stran 144,
146 - 150, 158)

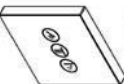

Raindance Showerpipe
(glejte stran 108)



Raindance Rainfall 240
(glejte stran 140, 142)



Raindance Rainfall 180
(glejte stran 154 - 158)

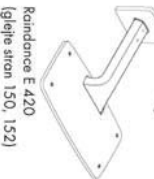

Raindance E 420
(glejte stran 150, 152)

Raindance Select E 300
(glejte stran 148)



Toormontaaž

IBox'i summeerilise ringlusega põhikorpus on universaal-selt kasutatav, nii horisontaalselt kui vertikaalselt. Va. turvokambinaatsiooniga vannimatuuri paigaldamisel, kus on võimalik ainult vertikaalne paigaldamine. Paigaldage iBox alati vanni kohale. Kui iBox'i osad lähevad katki, võib vesi vanni voolata!

iBox sobib niihästi vanni kui ka duši paigaldamiseks. Ühetae-vannisegisti / kateksiv- ja umberfüllusklapiiga termostaat puhul on alumine väljavool prioriteetne.

Duši paigaldamisel tuleb mittevajalik väljavool korriga ihendada.

Kui külm ja kuum vee ühenduste surve on väga erinev, tuleb need tasakaalustada.

Põhikorpus paigaldada nii, et soola vee liitmik oleks vasakul ja külma vee liitmik paremal.

Paigalduse sügavus 80 mm kuni 108 mm

pikendus 25 mm artikli number 13595000

pikendus 22 mm [kui sein ei ole piisavalt paks].

artikli number 13593000 / 13596XXX / 13597XXX / 15597000 / 19427000 / 97407XXX / 98860000

Põhikorpus on võimalik paigaldada vastavalt ehituslikele nõuandele, näiteid paigaldamise kohta vt lk 91 ja 92.

A Seinale paigaldamine.

B Seinale paigaldamine. Siin reguleeritava vahahooldiku-ga, kasutades 10 mm rikkpöle.

C Kandurisüsteemile paigaldamine.

D Paigaldamine kiirmonooziplaatidele või valmisakabiini.

E Paigaldamine otse seinale.

F Paigaldamine kinnitussindidega #96615000.

Paigaldusnõuded koos mõõtude info ja voolikute suurus-tega leiata alates leheküljest 96. Kasutades sümbolite selgitsusel leiata lehekülgedel 69 ja 70.

Paigaldusjuhendis esitatud paigaldusmõõdud on ideaalsed u. 1800 mm pikkustele inimestele ning vajadusel tuleb neid kohandada. Seejuures tuleb silmas pidades, et muutunud paigalduskõrguse korral muutub ka minimaalne kõrgus ning tuleb arvestada, et erinevad on ka ühendusmõõdud.

Paigaldusnõuanded

Ühendusdetailide sissekeeramiseks kinnitage iBox toru abil kruvisüsteemisse.

Äravoolu süsteem

Pärast paigaldamist vastavalt standardile DIN 1988 / EN 1717 läbi pesti. Loputusploki olevad nooled näitavad, milline pealvool on millise äravoolumirga seotud, ni külm vesi äravoolduga 1 ja soe vesi äravoolduga 2. Kui on vaja ainult ühte äravoolu, tuleb loputusplokki pärast esimest loputust 90° keerata.

iBox ühenduses ära- ja ülevoolugarni-tuuriga Exafilli vanni sisesevooluga (vt lk 95)

Tehnilised andmed

Töörõhk	maks. 1 MPa
Soovitatav töö rõhk:	0,1 - 0,5 MPa
Kontrollsurve:	1,6 MPa
(1 MPa = 10 baari = 147 PSI)	
Kuum vee temperatuur:	maks. 80 °C
Soovitatav kuum vee temperatuur:	65 °C
distantis kehteli:	G ¾
ühendused:	külm poremol, kuum vasakul
Äravoolu surve 0,3 MPa	31 l/min // 24 l/min
Vanni-duši segisti:	25 l/min // 24 l/min
Turvosüsteemiga vanni-duši segisti:	32 l/min
dušisegisti:	43 l/min
Termostaat:	26 l/min
Karikesüsteemilapiiga termostaat:	26 l/min
Karikesiv- ja umberfüllusklapiiga termostaat:	58 l/min
Termostaat High Flow:	30 l/min
iControl:	

X Vanni keskkoht / Dusivanni keese



peteliklopp

Y Mõeti Y – vooliku seinaväljavoolu keskmeset vannitühri keskele jalgatud 2-ga (võimalusel kohandage keramiiliste pliitide asetusega).



Quattro-liimik

Soe vesi



Kaakestus- ja ümberlülitsklopp Trio Universal

Külm vesi



Trio

Alates • on funktsioneerimine garanteeritud



Vanni kroon

Selles alaos tuleb seinatugevdada.



Mittetavalik väljavool tuleb sulgeda korraga. (DN 20 3/4")

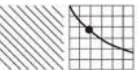

Ärvoolu jõudlus peab olema suurem kui 50 l/min.



Ärvool



Võimalik on ainult üks funktsioon, mitte kaks korraga.
Paigaldage kehitudüsi jooks voolikuid veetoruud kaldlega.



Raindrain

iBox ühenduses dro- ja ülevoolugarnituuriga Exaffili vannitissevooluga (vt lk 95)



DVGW Turvasüsteemiga vannidüsi segisiti (vt lk 96)



düsi segisiti (vt lk 104, 106, 110, 124)

Vannidüsi segisiti (vt lk 98, 102, 114, 116)



Vanni kroon (vt lk 102)

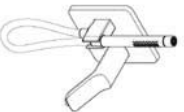

Termostaat
[vt lk 118, 122, 126]



High Flow Termostaat
[vt lk 128 - 138, 142, 144, 150-158]



Kaitestusklappiga termostaat
[vt lk 104, 106, 110, 124]



Kaitestus- ja ümberlülitsuklappiga termostaat
[vt lk 98, 114, 116, 120]



High Flow Kaitestusklappiga termostaat
[vt lk 140, 146, 148]

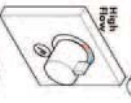

Kaitestusklappiga termostaat
[vt lk 104, 106, 110]

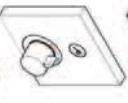

Kaitestusklappiga termostaat
[vt lk 98, 114, 116, 120]

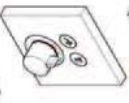

Kaitestusklappiga termostaat
[vt lk 100, 112]



ShowerSelect duitssegitli
[vt lk 104, 106, 110]

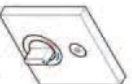

ShowerSelect Vanni-duiti segisiti
[vt lk 98, 114, 116, 120]



iControl
Kaitestus- ja ümberlülitsuklapp [vt lk 150]



ShowerSelect
3 x võkustus klapp [vt lk 144, 146-150, 158]

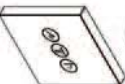

Raindance Showerpipe
[vt lk 108]



Raindance Rainfall 240
[vt lk 140, 142]



Raindance Rainfall 180
[vt lk 154 - 158]

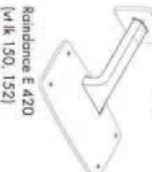

Raindance E 420
[vt lk 150, 152]



Raindance Select E 300
[vt lk 148]

Cauruļu montāža

Rokācija sīmeiriskais iBox korpusu ir izmantojams universālā - li - gan horizontāli, gan vertikāli. Izņemot godījumus, kad veic vannas armatūras montāžu ar drošības kombināciju -žādos godījumus iespējama tikai vertikālo iebūve. Tā kā funkcionālo detaļu bojļošanu godījumā no iBox daļas var izpūst ūdens, iBox jāmontē virs vannas, lai izpūstotais ūdens varētu nolēcti vannā!

iBox ir piemērots gan vannu, gan dušu instalācijām.

Vannas jaucekļrāņiem ar vienu / Termosists ar noslēgtvārstu un pārslēdzēlvārstu, rokturi apakšējai izpūdei ir svarīgs, lai izpūstotais ūdens, nevojadzīgā izpūde jānoblivē ar atdzāzni.

Jāizdzena spiediena atšķirības starp aukstā un karstā ūdens pievadiem.

Korpusu iebūvējiet tā, lai silta ūdens pieslēgums atstātos pa kreisi un aukstā ūdens pieslēgums - pa labi.

Iebūvēšanas dziļums 80 mm (Izāz 108 mm.

Pogarinājumus 25 mm artikla numurs 13595000

Pogarinājumus 22 mm (Ja iebūvēšanas dziļums nav pietiekams)

artikla numurs 13593000 / 13596XXX / 13597XXX / 15597000 / 19427000 / 97407XXX / 98860000

Korpusu iespējams iebūvēt atbilstoši konstrukcijas īpašībām, montāžas piemērus skat. 91. un 92. lpp.

A Instalācija pie sienas.

B Instalācija pie sienas. Šeit ar elastīgu starplikku un 10 mm izmēro montāžas skrūvēm.

C Montāža uz balstu sistēmu.

D Instalācija uz gataviem montāžas paneļiem vai gataviem elementiem.

E Instalācija tieši sienā.

F Instalācija ar montāžas sližu komplektu #96615000.

Uzstādīšanas piemēri ar izmēriem un vadu izkārtojumu atrodami sākot no 96.lappuses. Lietotā simbolu izskaidrojums atrodams 72 un 73.lappusē.

Montāžas instrukcijās dotie montāžas izmēri ir ideāli piemēroti personām, kuru augums ir apm. 1800 mm. Nepieciešamības gadījumā šie izmēri ir jāpielāgo. Šeit ir ņemti vērā, ka mainoties montāžas augstumam, mainās arī minimālais augstums, un jāņem vērā arī pieslēgšanas izmēru izmaiņas.

Montāžas padoms

Lai iegriestu savienojuma elementus, iBox ar caurules palīdzību nostipriniet skrūvspriekš.

Skalošana

Izskalojiet visu instalāciju atbilstoši DIN 1988 / EN 1717. Bulļiens uz skalošanas bloka porādo, kurš pievada ir savienots ar atliecīgo izpūdes cauruli, piem., aukstais ūdens ar 1. izpūdi un siltais ūdens ar 2. izpūdi. Ja nepieciešama tikai viena izpūde, pēc pirmas skalošanas režises por 90° jāpogrīnēz skalošanas bloks.

iBox kombinācijā ar Exafill vannas iebūvē un noplūdes un pārplūdes garnitūru (skat. 95. lpp.)

Tehniskie dati

Darba spiediens:	maks. 1 MPa
Ieteicamais darba spiediens:	0,1 - 0,5 MPa
Pārbaudes spiediens:	1,6 MPa
(1 MPa = 10 bar = 147 PSI)	
Karstā ūdens temperatūra:	maks. 80 °C
Ieteicamā karstā ūdens temperatūra:	65 °C
Pieslēguma izmēri:	G ¾
Pieslēgumi:	aukstais pa labi - karstais pa kreisi
Brīva caurplūde, ja ir 0,3 MPa:	31 l/min // 24 l/min
Vannas/ dušas jaucekļrāns:	
nāciju:	25 l/min // 24 l/min
Dušas jaucekļrāns:	32 l/min
Termosists:	43 l/min
Termosists ar slēgvārstu:	26 l/min
Termosists ar noslēgvārstu un pārslēdzēlvārstu.:	26 l/min
Termosists High Flow:	58 l/min
iControl:	30 l/min

X

Vannas vidus / Dušas paliktno vidus



Zemopmetuma ventilis

Y

Izmērs Y – šūļenes savienojuma loka vidū līdz vannas ietecece vidum daļi ar 2 (eventuāli piemēroti filīzu rakstam)



Četrvirzienu pārslēgls

Siltais ūdens



Quattro

Trisvirzienu universālais noslēgvārsts un pārslēdzējvārsts

Aukstais ūdens



Trio

No • funkcija nodrošināta

Vannas tekne



Neizmantolo izteku aizbāzī ar aizbāzni. (DN 20 3/4")



Šajā zonā ir nepieciešams pastiprināt sienu.

Noieces veiktspēja jābūt vairāk nekā 50 l/min.



Montēt ūdens cauruļvadus sānu (ķermeņa) dušām ar atbilstošu slīpumu.

Noiece



Skatīšanas bloks, kompl. # 159256000, komplekta netiek piegādāts



Raindrain



Exatfill

iBox kombinācija ar Exatfill vannas iepilnīti or noplūdes un pārplūdes garnīturn (skat. 95. lpp.)

DVGW



Vannas/ dušas iaucējktrāns ar integrētu drošības kombināciju (skat. lpp. 96)



Dušas iaucējktrāns (skat. lpp. 104, 106, 110, 124)



Vannas/ dušas iaucējktrāns (skat. lpp. 98, 102, 114, 116)

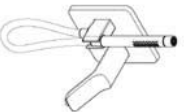

Vannas tekne (skat. lpp. 102)

Termostats
(skat. lpp. 118, 122, 126)



High Flow Termostats
(skat. lpp. 128 - 138, 142, 144, 150 - 158)



Termostats ar slēgvārstu.
(skat. lpp. 104, 106, 110, 124)



Termostats ar noslēgvārstu un pārslēdzējvārstu.
(skat. lpp. 98, 114, 116, 120)



High Flow Termostats ar slēgvārstu.
(skat. lpp. 140, 146, 148)

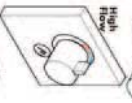

Termostats ar slēgvārstu.
(skat. lpp. 104, 106, 110)

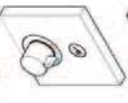

Termostats ar slēgvārstu.
(skat. lpp. 98, 114, 116, 120)

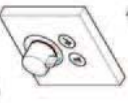

Termostats ar slēgvārstu.
(skat. lpp. 100, 112)



ShowrSelect Dušas ļaucējkāns
(skat. lpp. 104, 106, 110)

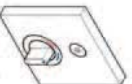

ShowrSelect Vannas/ dušas ļaucējkāns
(skat. lpp. 98, 114, 116, 120)



iControl
Noslēgvārstis un pārslēdzējvārstis [skat. lpp. 150]



ShowrSelect
3 x Slēgvārstis [skat. lpp. 144, 146 - 150, 158]

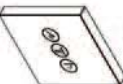

Raindance Showerpipe
(skat. lpp. 108)



Raindance Rainfall 240
(skat. lpp. 140, 142)



Raindance Rainfall 180
(skat. lpp. 154 - 158)



Raindance E 420
(skat. lpp. 150, 152)

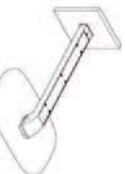

Raindance Select E 300
(skat. lpp. 148)

Priprema montaže

Rotaciono simetrično telo jedinice iBox je univerzalno primenljivo, kako horizontalno tako i vertikalno. Izuzetak predstavlja montaža armatura za kade sa sigurnosnom kombinacijom, jer tu moguće samo vertikalna ugradnja. Pošto kod kvara pojedinih delova iz iBox-a može isticati voda, iBox se mora instalirati iznad kade, tako da voda može isticati u kadu!

iBox je pogodan za ugradnju na tuš i instalaciju za kade. Kod jednoručnih mešača za kadu / termostata s ventilom za zatvaranje i preklapnim ventilom prioritetan je donji izlaz. Kod instalacije na tuš izlaz koji se ne upotrebljava mora da se zatvori čepom.

Velika razlika u pritisku između vruće i hladne vode mora biti izbalansirana.

Montirajte telo tako da priključak tople vode bude sa leve, a hladne sa desne strane.

Dubina ugradnje 80 - 108 mm.

Produžetak 25 mm br. Proizvoda 13595000

Produžetak 22 mm (kod manje dubine ugradnje)

br. Proizvoda 13593000 / 13596XXX / 13597XXX / 15597000 / 19427000 / 97407XXX / 988600000

Telo može da se montira u skladu sa uslovima na mestu ugradnje, za primere montaže vidi strane 91 i 92.

A Direktna instalacija na zid.

B Direktna instalacija na zid s držačem odstojanja pomoću 10 mm podesevih zavrtnjača.

C Montaža na sistem nosača.

D Instalacija na gotove montažne ploče ili gotove ćelije.

E Instalacija direktno u zid.

F Instalacija sa setom instalacionih šina #96615000.

Primeri instalacije sa veličinama i dimenzijama vodova mogu se naći od stranice 96 nadalje. Ojačanje korišćenih simbola nalazi se na stranici 75 i 76.

Montažne dimenzije navedene u uputstvu za montažu idelone su za osobe visine oko 1800 mm, tako da se po potrebi moraju prilagoditi konkretnoj visini korisnika. Pri tome treba uzeti u obzir da se prilikom promene montažne visine menja i minimalna visina kao i da se u tom slučaju mora uzvati i promena priključnih dimenzija.

Savet u vezi montaže

Za uvrtnje priključnih elemenata iBox treba zategnuti u stepu uz pomoć komada cevi.

Ispiranje

Kompletnu instalaciju treba ispirati u skladu sa normom DIN 1988 / EN 1717. Strelice na bloku prikazuju koji je dovod spojen sa kojim odvodom, npr. hladna voda sa odvodom 1, a topla voda sa odvodom 2. Ukoliko je potreban samo jedan odvod, onda se nakon prvog ispiranja blok mora zakrenuti za 90°.

iBox u kombinaciji sa Exafill dotokom kade sa odvodnom i prelivnom garniturom (vidi stranu 95)

Tehnički podaci

Radni pritisak:	maks. 1 MPa
Preporučeni radni pritisak:	0,1 - 0,5 MPa
Probi pritisak:	1,6 MPa
(1 MPa = 10 bar = 147 PSI)	
Temperatura vruće vode:	maks. 80 °C
Preporučena temperatura vruće vode:	65 °C
Rastojanje između centara priključaka:	G ¾
Priključci:	hladna voda desno - topla leva
Slobodan protok na 0,3 MPa:	31 l/min // 24 l/min
Mešač za kadu:	
Mešač za kadu s ugrađenim sigurnosnim sistemom:	25 l/min // 24 l/min
Mešač tuša:	32 l/min
Termostat:	43 l/min
Termostat s ventilom za zatvaranje:	26 l/min
Termostat s ventilom za zatvaranje i preklapnim ventilom:	
26 l/min	
Termostat High Flow:	58 l/min
iControl:	30 l/min

X

Sredina kade / Sredina tuš-kada



Uzdni ventil

Y

Mera Y – sredina priključnog luka ceva do sredine donjaka kade podeljeno sa 2 (eventualno prilagoditi rasteru pločica).



Quattro četvorostruki preusmerivač



Topla voda

Hladna voda

Od • je funkcija zagarantovana.

U ovoj oblasti je potrebno ojačanje zida.

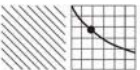

Moguće je koristiti samo jedan potrošač, nikako dva istovremeno!

Položite vodovodne cevi za bočni tuš s nagibom.



kompletni blok #15956000, Nije sadržano u isporuci

DVGW



Mešač za kadu s ugrađenim sigurnosnim sistemom (vidi stranu 96)



Mešač za kadu (vidi stranu 98, 102, 114, 116)



Exafill

Kapacitet odvodja mora biti veći od 50 l/min.

Ispust

iBox u kombinaciji sa Exafill dotokom kade sa odvodnom i prelivnom garnitурom (vidi stranu 95)

Mešač tuša (vidi stranu 104, 106, 110, 124)



Dotek kade (vidi stranu 102)

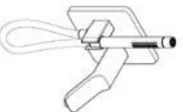



Termostat
(vidi stranu 118, 122, 126)



High Flow Termostat
(vidi stranu 128 – 138, 142, 144,
150 - 158)



Termostat s ventilom za zatvaranje
(vidi stranu 104, 106, 110, 124)



Termostat s ventilom za zatvaranje i
preklapnim ventilom
(vidi stranu 98, 114, 116, 120)

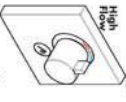

High Flow Termostat s ventilom za
zatvaranje
(vidi stranu 140, 146, 148)

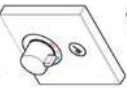

Termostat s ventilom za zatvaranje
(vidi stranu 104, 106, 110)

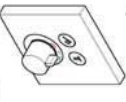

Termostat s ventilom za zatvaranje
(vidi stranu 98, 114, 116, 120)



Termostat s ventilom za zatvaranje
(vidi stranu 100, 112)



ShowerSelect Mešač tuša
(vidi stranu 104, 106, 110)

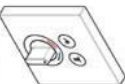

ShowerSelect Mešač za kudu
(vidi stranu 98, 114, 116, 120)



iControl
Venil za zatvaranje i preklapni venil
(vidi stranu 150)

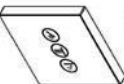

ShowerSelect
3 x Venil za zatvaranje (vidi stranu
144, 146 - 150, 158)



Raindance Showerpipe
(vidi stranu 108)



Raindance Rainfall 240
(vidi stranu 140, 142)



Raindance Rainfall 180
(vidi stranu 154 - 158)



Raindance E 420
(vidi stranu 150, 152)



Raindance Select E 300
(vidi stranu 148)

Råmontasje

Det rotasjonsymmetriske baseelementet til Box kan brukes universelt dvs. horisontalt og vertikalt. Et unntak er ved montasje av kararmatur med sikkerhetskombinasjon.

Da er det kun mulig med vertikal montasje. Etersom det kan lette vann ut av Boxen ved en defekt, skal Boxen monteres over badekaret, slik at vannet som lekker ut kan renne ned i badekaret.

Boxen egner seg både for installasjon på dusj eller badekar. Ved enhåndblandebatteri for badekar / termostat med sperre- og omslingingsventil prioriteres nedre utgangen. Ved installasjon i dusjen skal utgangen som ikke brukes tettes med en plugg.

Store trykkdifferanser mellom kaldt- og varmvannstilkoblinger skal utlignes.

Baseelementet bygges inn slik at varmvannstilkobling er på venstre og kaldvannstilkobling er på høyre side.

Innbyggingsdybde 80 mm til 108 mm.

Førlengelse 25 mm Artikkelnummer 13595000

Førlengelse 22 mm (ved liten montasje dybde)

Artikkelnummer 13593000 / 13596XXX / 13597XXX / 15597000 / 19427000 / 97407XXX / 98860000

Baseelementet kan monteres iht. byggmessige forhold, se montasje-eksempel på side 91 og 92.

A Installasjon på vegg

B Installasjon på vegg. Her med fleksible avstandsholdere via spesialskruter.

C Montasje på bæresystem.

D Installasjon på ferdighusmontasjeplater eller prefabrikkert celler.

E Installasjon rett på vegg.

F Installasjon med sett av montasjeskinner #96615000.

Installasjonseksempel med målangivelser og ledningsdimensjoner finns fom. side 96. Forklaring for brukte symboler på side 78 og 79.

Monteringsmål i monteringsveiledningen er beregnet for personer som er omtrent 1800 mm høyre, målene skal eventuelt tilpasses om nødvendig. Her skal man passe på at ved endrede monteringsmålene blir minste høyden endret, og det må tas hensyn til de endrede tilkoblingsmålene.

Montasje-tipp

For å skru inn koblinger skal Boxen settes fast i en skruer ikke ved hjelp av et rør.

Spyle

Komplett installasjon spyles iht. DIN 1988 / EN 1717. På lene på spyleblokken indikerer hvilke tilsløp som er koblet sammen med hvilken utgangsledning, f.eks. kaldvann med utgang 1 og varmvann med utgang 2. Hvis det kun er nødvendig med en utgang, skal spyleblokken dreies med 90° etter den første spylingen.

IBox i kombinasjon med Exfill karinløp med avløps- og overflytgarnityr (se side 95)

Tekniske data

Driftstrykk	maks. 1 MPa
Anbefalt driftstrykk:	0,1 - 0,5 MPa
Prøvetrykk	1,6 MPa
(1 MPa = 10 bar = 147 PSI)	
Varmvannstemperatur	maks. 80 °C
Anbefalt temperatur for varmt vann	65 °C
Tilkoblingsmål:	G ¾
Tilkoblinger:	kaldt høyre - varmt venstre
Fri gjennomsstrøming ved 0,3 MPa:	31 l/min // 24 l/min
Blondbatteri for badekar:	25 l/min // 24 l/min
Blondbatteri for badekar med integrert sikkerhetskombinasjon:	25 l/min // 24 l/min
Dusj-blandebatteri:	32 l/min
Termostat:	43 l/min
Termostat med sperreventil:	26 l/min
Termostat med sperre- og omslingingsventil:	26 l/min
Termostat High Flow:	58 l/min
iControl:	30 l/min

X Midten av badekaret / Midten på dusjkar



Innfelt ventil

Y Mål Y = Midten til slangekobleingsbue
i.o.m. badekarinnløp deli på 2 (eventuelt
skal filteraster tilpasses).



Quattro fire-veis omslingling

Quattro

Trio universal stenge- og omslinglingsventil

Varmtvann

Kaldtvann



Trio

Innløp badekar

F.o.m. • er funksjonen garantert



Utgangen som ikke brukes kan testes med
en blindplugg. (DN 20 3/4")



Avløp yreløse skal være mer enn 50 l/min.



> 50 l/min

Avløp



Raindrain

iBox i kombinasjon med Exfill korrinløp
med avløps- og overflygarnhjør (se side
95)



Exfill



Vannledninger for sidedusjer installeres
med fall.



Spyleblokk kpl. #15956000, ikke med i
leveransen

DVGW

Blandebatteri for badekar med
integriert sikkerhetskombinasjon
(se side 96)



Blandebatteri for badekar
(se side 98, 102, 114, 116)



Dusjblandebatteri
(se side 104, 106, 110, 124)



Innløp badekar
(se side 102)

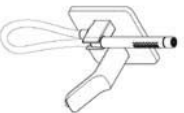



Termostat
(se side 118, 122, 126)



High Flow Termostat
(se side 128 - 138, 142, 144, 150 - 158)



Termostat med sperreventil
(se side 104, 106, 110, 124)



Termostat med sperre- og omslingsventil
(se side 98, 114, 116, 120)

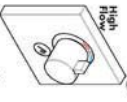

High Flow Termostat med sperreventil
(se side 140, 146, 148)

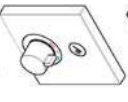

Termostat med sperreventil
(se side 104, 106, 110)

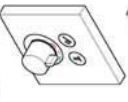

Termostat med sperreventil
(se side 98, 114, 116, 120)



Termostat med sperreventil
(se side 100, 112)

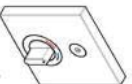

ShowerSelect Dug-bløddbatteri
(se side 104, 106, 110)

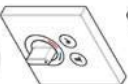

ShowerSelect Bløddbatteri for badekar
(se side 98, 114, 116, 120)

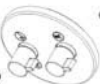

iControl
Slenge- og omslingsventil (se side 150)

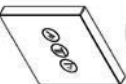

ShowerSelect
3 x Sperreventil (se side 144, 146 - 150, 158)

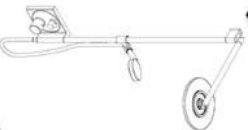

Raindance Showerpipe
(se side 108)



Raindance Rainfall 240
(se side 140, 142)

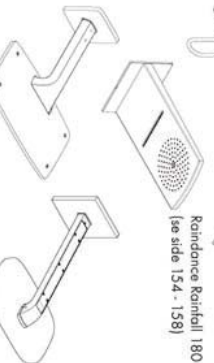

Raindance Rainfall 180
(se side 154 - 158)



Raindance E 420
(se side 150, 152)



Raindance Select E 300
(se side 148)

Първичен монтаж

Ротационно-симетричното основно тяло на iBox може да се приложи универсално, хоризонтално и вертикално. Изключение прави монтажът на арматурата за ванна с комплект предизтигтели, тук е възможен само вертикален монтаж. Тък като при дефект на функциониранияте части около iBox може да изтече вода, iBox трябва да се монтира над ваната, за да може изтичащата вода да се отича във ваната!

iBox е подходящо както за инсталации на ванни, така и за душове. При смесители за ванна с едно ръкохватка / термостат със спирателен и превключващ клапан първоначален е долният извод. При инсталация на разпръсквателен илищият извод трябва да се улътни с тухла пробка.

Горемите розетки в налягането между изводите за студентата и топлата вода трябва да се изравняват.

Основното тяло се монтира така, че изводът за топла вода да се намира отвъд, а за студена вода отвъсно. Монтажно дълбочина 80 мм до 108 мм.

Удължител 25 мм Номенклатурен номер 13595000
Удължител 22 мм (при малка монтажна дълбочина)

Номенклатурен номер 13593000 / 13596XXX /
13597XXX / 15597000 / 19427000 / 97407XXX /
98860000

Основното тяло може да се закрепят на стената в съответствие с конструктивните долености, примери за монтаж на стр. 91 и 92.

A Инсталация на стената.

B Инсталация на стената. Тук с павкова розетка с помощта на комбинирани болгове 10.

C Монтаж на третираната система.

D Инсталация върху монтажни плочи на спобявими стрази или готови клетки.

E Инсталация директно в стената.

F Инсталация с набор монтажни шини #96615000.

Примери за инсталация с данни за размери и опре- делене на размерите на тръбопровода може да намерите от стр. 96 нататък. Различения на изпозда- ните символи на стр. 81 и 82.

Посочените в ръководството за монтаж монтажни мерки са дадени за лица с ръст от прикл. 1800 мм и трябва съответно да се приполад. При това обръчате внимание на това, при променен монтаж височина се променя минималното височина и трябва да бъде взето под внимание промяната на присъединителните размери.

Съвети при монтаж

За да завинтите присъединителните елементи затегне- те iBox с помощта на грабчен елемент в менюта.

Промиване

Промийте цялото инсталация съгласно DIN 1988 / EN 1717. Стрелките на промиващия блок показват, кой вход с кой изходът тръбопровода е свързан, напр. студена вода с извод 1, а топла вода с извод 2. В случай, че е необходим само един изход, след първия процес на промиване промиващият блок трябва да се завърти на 90°.

**iBox в комбинация с вход за ванна
ExaFill с гарнитура за изтичане и пре-
ливане.** (вижте стр. 95)

Технически данни

Работно налягане:	макс. 1 MPa
Препоръчително работно налягане:	0,1 - 0,5 MPa
Контролно налягане:	1,6 MPa
(1 MPa = 10 bar = 147 PSI)	
Температура на горещата вода:	макс. 80°C
Препоръчителна температура на горещата вода:	65°C
Присъединителни размери:	G ¾
Изводи:	студено отвъдно – топло отвъдно
Свободен поток при 0,3 MPa:	31 л/мин // 24 л/мин
Смесител за ванна:	
Смесител на ванна с интегриран комплект предпази- телни:	
	25 л/мин // 24 л/мин
Смесител на разпръсквател:	32 л/мин
Термостат:	43 л/мин
Термостат със спирателен клапан:	26 л/мин
Термостат със спирателен и превключващ клапан:	26 л/мин
Термостат High Flow:	58 л/мин
iControl:	30 л/мин

X Средо на ваната / Средо на коритото на душ-кабината



Клапан за мозилка

Y

Марка Y – Средо на присъединителното коляно на морчуца до входа на ваната разделено на 2 (авентурално изравнене към ролстери на плочките).



Quattro

Четирипътно превключващо Quattro

Топла вода



Trio

Спирателен и превключващ клапан Trio Universal

Студена вода

От • функцията е гарантирана.



Вход за ванна

В тази област е необходимо подсилване на стената.



Изпишният извод може да се уплътни с глуха пробка. (DN 20 3/4")

Възможен е само един консулатор, не два едновременно.



> 50 l/min

Отвеждане

Водопроводните линии за страничните разпръскатели полагайте с наклон.



Raindrain

!Box в комбинация с вход за ванна Exhill с горнитурата за изтичане и преливане. (вижте стр. 95)



Exhill

DUSH

Смесител на ванна с интегриран комплект предпазителни (вижте стр. 96)



Смесител на разпръскаателя (вижте стр. 104, 106, 110, 124)

Смесител за ванна (вижте стр. 98, 102, 114, 116)

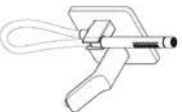

Вход за ванна (вижте стр. 102)



Термостат
(вижте стр. 118, 122, 126)



High Flow Термостат
(вижте стр. 128 – 138, 142, 144,
150, 158)



Термостат със спирателен клапан
(вижте стр. 104, 106, 110, 124)



Термостат със спирателен и прена-
ключващ клапан
(вижте стр. 98, 114, 116, 120)

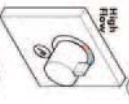

High Flow Термостат със спирателен
клапан
(вижте стр. 140, 146, 148)

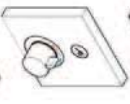

Термостат със спирателен клапан
(вижте стр. 104, 106, 110)

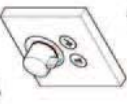

Термостат със спирателен клапан
(вижте стр. 98, 114, 116, 120)



Термостат със спирателен клапан
(вижте стр. 100, 112)



ShowerSelect Смесител на разляжък-
ватаи
(вижте стр. 104, 106, 110)

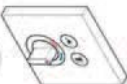

ShowerSelect Смесител за вана
(вижте стр. 98, 114, 116, 120)



Control
Спирателен и преключващ клапан
(вижте стр. 150)

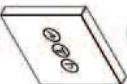

ShowerSelect
3 x Спирателен клапан (вижте стр.
144, 146, 150, 158)



Raindance Showerpre
(вижте стр. 108)



Raindance Rainfall 240
(вижте стр. 140, 142)



Raindance Rainfall 180
(вижте стр. 154, 158)



Raindance E 420
(вижте стр. 150, 152)



Raindance Select E 300
(вижте стр. 148)

Montimi në vija të trasha

Tripi bazë me rotacion simetrik i iBox-i mund të përdoret në mënyrë universale, si horizontalisht, ashtu edhe vertikalisht. Me përfundim të montimit të armaturës së vaskës me kombinim me elemente sigurie. Kështu është i mundur vetëm montimi vertikal. Meqë në rast të ndonjë defekti të pjesëve funksionale mund të rriçdhë uji nga iBox-i, është e nevojshme që iBox-i të montohet sipër vaskës, me qëllim që uji që rriçdh të derdhet në vaskë! iBox-i është i përshatshëm si për instalimin me vaskën, ashtu edhe me dushin. Te rubinetet me një dorëzë për përzierjen e ujit për vaskën / termostati me ventil bllokues dhe ventil për ndërrimin e pozicionit ka prioritet dalje e poshtme. Në rast se instalohet dushi, atëherë dalje që nuk nevojitet duhet mbyllur me një tapë. Ndryshimet e mëdha të presionit mes lidhjeve të ujit të ftohje dhe uji të ngrohtë duhen ekuilibruar.

Tripi bazë duhet montuar në atë mënyrë që lidhja e ujit të ngrohtë të jetë në të majtë dhe ajo e ujit të ftohje në të djathtë.

Thellessia e montimit 80 mm deri 108 mm.

Zgjatësi 25 mm Numri i artikullit 13595000

Zgjatësi 22 mm (Iartësia e montimit jo e madhe)

Numri i artikullit 13593000 / 13596XXX / 13597XXX / 15597000 / 19427000 / 97407XXX / 98860000

Tripi bazë mund të montohet duke iu përshotur kushëve ndërimore. Shembuj të montimit gjinden në faqet 91 dhe 92.

A Instalimi në mur.

B Instalimi në mur. Këtu me distancues të lakueshëm përmas vëkave lidhëse 10-8he.

C Montimi në sistemin mboqtes.

D Instalimi në pllakat e montimi të shëspive parafabrikate ose në qelizat e gotshme.

E Instalimi drektë në mur.

F Instalimi me kompletin e shirave të montazhit #96615000.

Shembujt e instalimit me përmasat dhe dimensionimet e tubacioneve mund t'i gjeni nga faqja 96. Shpjegjimi i simboleve të përdorura gjendet në faqen 84 dhe 85.

Përmasat e montimit të cekura në udhëzimin teknik të montimit janë ideale për personna me gjatësi afro 1800 mm (180 cm) dhe eventualeisht duhen përshotur. Këtu duhet posur parasysh që me ndryshimin e lartësisë së montimit, ndryshon edhe lartësia e cekur minimale si dhe ndryshimi i përmasave të lidhjeve.

Këshilla rreth montimit

Për të rrotulluar lidhjet duhet lidhur iBox/ me anë të një pjesë të tubit në morë.

Shpëlarje

I gjithë instalimi duhet shpërlarë në bazë të normës DIN 1988 / EN 1717. Shpërlarja në bllokun shpërlarës tregojnë se çlira hyrje është lidhur me cilën dalje, p.sh. uji i ftohje me daljen 1 dhe uji i ngrohtë me daljen 2. Nëse nevojitet vetëm një dalje, atëherë pos shpërlarjes së porë bllokut shpërlarës duhet rrotulluar 90°.

iBox-i në kombinim me në garniturë dalje dhe rriçdhëse Exafill hyrien e vaskës (shih faqen 95)

Të dhëna teknike

Presioni gjatë punës	maks. 1 MPa
Presioni i rekomanduar:	0,1 - 0,5 MPa
Presioni për provë:	1,6 MPa
(1 MPa = 10 bar = 147 PSI)	
Temperaturura e ujit të ngrohtë	maks. 80°C
Temperaturura e rekomanduar e ujit të ngrohtë:	65°C
Përmasat e lidhjeve:	G ¾
Lidhjet:	i ftohje/djajhtas - i ngrohtë/mojtas
Rriçdhja e lirë me 0,3 Mpa:	31 l/min // 24 l/min
Rubineti i vaskës:	
Rubineti i vaskës me kombinim të integruar të sigurisë:	25 l/min // 24 l/min
Shtërkiajsja me ujë të përzier:	32 l/min
Termostati:	43 l/min
Termostati me ventil bllokues:	26 l/min
Termostati me ventil bllokues dhe ventil për ndërrimin e pozicionit:	26 l/min
Termostati High Flow:	58 l/min
iControl:	30 l/min

Shqip

X Mesi i voskës / Mesi i voskës së dushit



Ventili i suvojës

Y

Përmaso Y – mesi i horkur të liqhlës së zorrës deri tek mesi i hyftës së voskës pjesëtim për 2 (eventualisht i duhet përshtatur këndit të pllakave të murit).



Valvul devijuese Quattro me kater drejtime

Uji i ngrohtë

Quattro

Valvul universale Trio për bllokim dhe devijim

Uji i ftohtë



Trio

Nga • është i mundur funksioni.



Vrima për mbushjen e voskës



Në këtë zonë është i nevojshëm një perforcim i murit.



Dolja që nuk nevojitet duhet izoluar me topë qorre. (DN 20 3/4")



Ekziston mundësia vetëm për një konsumator, jo për dy njëkohësisht.



Kapociteti i shkarkimit duhet të jetë më shumë se 50 l/minutë.



Vendosni tubacionet e ujit për spërkatëset onëzore me pjerësi:



Shkarkimi



Blloku shpëlarës komplet # 15956000, nuk përfshihet në veçimin e furnizimit



Raindrain



Exafill

iBoxi në kombinim me në gorniturë dalje dhe rripdhënë Exafill hyjen e voskës (shih faqen 95)

DVGW



Rubineti i voskës me kombinim të integruar të sigurisë (shih faqen 96)



Spërkatësja me ujë të përzier (shih faqen 104, 106, 110, 124)



Rubineti i voskës (shih faqen 98, 102, 114, 116)

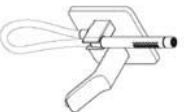

Vrima për mbushjen e voskës (shih faqen 102)

Termostati
(shih faqen 118, 122, 126)



High Flow Termostati
(shih faqen 128 - 138, 142, 144,
150 - 158)



Termostat me ventil bllokues
(shih faqen 104, 106, 110, 124)



Termostat me ventil bllokues dhe ventil
për ndërrimin e pozicionit
(shih faqen 98, 114, 116, 120)



High Flow Termostat me ventil bllokues
(shih faqen 140, 146, 148)

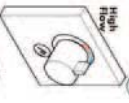

Termostat me ventil bllokues
(shih faqen 104, 106, 110)

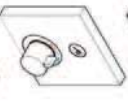

Termostat me ventil bllokues
(shih faqen 98, 114, 116, 120)

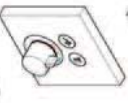

Termostat me ventil bllokues
(shih faqen 100, 112)



ShowerSelect SperiKontjo me ujë të
perzire
(shih faqen 104, 106, 110)

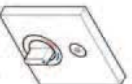

ShowerSelect Rubineti i vaskës
(shih faqen 98, 114, 116, 120)



iControl
Valvula e bllokimit dhe e derëzimit (shih
faqen 150)



ShowerSelect
3 x Ventil bllokues (shih faqen 144,
146 - 150, 158)

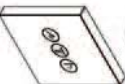

Raindance Showerpipe
(shih faqen 108)



Raindance Rainfall 240
(shih faqen 140, 142)



Raindance Rainfall 180
(shih faqen 154 - 158)



Raindance E 420
(shih faqen 150, 152)



Raindance Select E 300
(shih faqen 148)

ثيومستات
(راجع صفحة 118, 122, 126)



ثيومستات High Flow
(راجع صفحة 128 - 138, 142, 144, 150 - 158)



ثيومستات متصل بصمام غلق
(راجع صفحة 104, 106, 110, 124)



ثيومستات متصل بصمامات غلق
وختول
(راجع صفحة 98, 114, 116, 120)



ثيومستات High Flow
غلق
(راجع صفحة 140, 146, 148)

ثيومستات متصل بصمام غلق
(راجع صفحة 104, 106, 110)

ثيومستات متصل بصمام غلق
(راجع صفحة 98, 114, 116, 120)

ثيومستات متصل بصمام غلق
(راجع صفحة 100, 112)



ShowerSelect
خلاط الدش
(راجع صفحة 104, 106, 110)

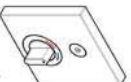

ShowerSelect خلاط من الصمام
(راجع صفحة 98, 114, 116, 120)

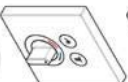

Control
صمام الحجر والتغير (راجع صفحة 150)



ShowerSelect
3 x صمام إبطاف (راجع صفحة 144, 146, 150 - 158)

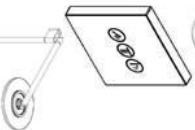

Raindance Showerpipe
(راجع صفحة 108)



Raindance Rainfall
180
(راجع صفحة 154 - 158)

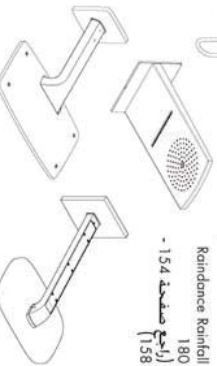

Raindance E 420
(راجع صفحة 150, 152)

Raindance Select E 300
(راجع صفحة 148)

X

متنصف حوض الاستحمام / بانيو مزود
ببش في المنتصف

صمام التدفق

Y

البعد $Y =$ مركز مرفق مخرج حائط
الخرطوم إلى مركز حشوة الصمام مقسوماً
على 2 أمطابق لشكل البلاطة إن أمكناً.

تغيير مسار رياحي كوابلو

ماء دافئ



صمام حنجرة وتغيير تروبو يونيفرسال

ماء بارد



Trio

من * الوظيفة مضمونة.



مدخل مياه للبانو



يلزم هذا في النطاق وجود تقوية للحائط.



قم بسد المنفذ غير المستخدم، DN 20



3/4"



لا يمكن القيام بالكتر من وظيفة واحدة.

يجب أن تكون قدرة الصرف أكبر من 50
لتر/دقيقةقم بتثبيت مواسير المياه للشد العادي
الصخر.

تصريف

قارئة وحدة القسمل #15956000، غير
مدح مع الفتوات السائلة

Exofill

وحدة "Box" مع وحدة التدفق بالخرن
من النوع "Exofill" مع لوازيم تصريف للم
وتصريف تدفق المياه. (راجع صفحة 95)

DVGW

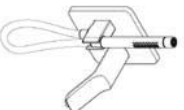
خلط بش الصمام مجموعة أمن مضمونة
(راجع صفحة 96)خلط المش
(راجع صفحة 104, 106, 110, 124)خلط بش الصمام
(راجع صفحة 98, 102, 114, 116)مدخل مياه للبانو
(راجع صفحة 102)

تعد أبعاد التركيب الواردة في إرشادات التركيب هذه متطابقة بالمتسقة للأشخاص الذين يبلغ طولهم حوالي 1800 م، ولكن تغيير الأبعاد عند الحاجة وبالتالي ستبقى لك الأثرى لا يرتفع في حالة تغيير ارتفاع التركيب، ما يعني الأثر في الاعتبار تغيير أبعاد التوصيل.

نصائح خاصة بعملية التركيب

من أجل لكf الوصلات، يجب تركيب وحدة "Box" في اللزومة باستخدام أنبوبة.

نظام سريان الماء عبر المواسير

يجب غسل الوحدة المركبة بالكامل وفقاً للمعيار DIN 1717 / EN 1988. تخد الأوسم الموجودة على وحدة الغسل أي فيع يرتبط بالة وصلة متدفق على سبيل المثال: المياه الباردة مع التدفق رقم 1، والمياه الساخنة مع التدفق رقم 2. إذا كان هناك حاجة إلى منفذ واحد فقط يجب لكf وحدة الغسل قبل أول استخدام لها بنسبة 90 درجة.

وحدة "Box" مع وحدة التدفق بالعرض من النوع "Exaffil" مع لوازيم تصريف الماء وتصريف تدفق المياه. (راجع صفحة 95)

المواصفات الفنية

ضغط التشغيل	الحد الأقصى 1 ميجاسكال
ضغط التشغيل الموصى به:	0,5 - 0,1 ميجاسكال
ضغط الاختبار:	1,6 ميجاسكال
1) درجة حرارة الماء الساخن	10 بار = 147 PSI
2) درجة الحرارة الموصى بها للماء الساخن:	80°C
3) المسافة المركبة:	65°C
الوصلات:	3/4 G
المعدل تدفق 0,3 ميجاسكال:	
حلاط شش الحطام:	31 لتر / الدقيقة // 24 لتر / الدقيقة
حلاط شش الحطام بمجموعة أمن مدمجة:	25 لتر / الدقيقة // 24 لتر / الدقيقة
حلاط الدش:	32 لتر / الدقيقة
ثرموستات:	43 لتر / الدقيقة
ثرموستات متصل بصمام غلق:	26 لتر / الدقيقة
ثرموستات متصل بصمامات غلق وكحول:	26 لتر / الدقيقة
ثرموستات High Flow:	58 لتر / الدقيقة
ثرموستات Control:	30 لتر / الدقيقة

تركيب الأنابيب

يتم استخدام الجسم الرئيسي لنبودوران اللشمال للوحدة "Box" في جميع أنحاء العالم سواء بصورة أفقية أو رأسية، إلا أنه لا يمكن القيام بالتركيب إلا بصورة رأسية في هذه الحالة إلا في حالة تركيب لوازيم بالعرض باستخدام تركيبية الأمان. المحرض دوماً على تركيب Box فوق حوض الاستحمام الباليوياً، إذا تعرضت أجزاء من Box للأشخاص، فربما يتسبب ذلك في تسرب المياه في كل مكان.

تعد وحدة "Box" ملائمة لتركيب حوض الاستحمام أو الدش، وفي حالة استخدام حلاط بالعرض يستنور واحد فقط / ثرموستات متصل بصمام غلق وكحول يفضل استخدام الصراف السفلي، وعند القيام بتركيب الدش، يجب سد المنفذ غير المستخدم عن طريق سدادة.

يجب أن يكون تيار الماء الساخن والماء البارد متعادلين في الضغط.

قم بتركيب الجسم الرئيسي للوحدة بصورة ملائمة بحيث توجد وصلة المياه الساخنة في الجانب الأيسر ووصلة المياه الباردة في الجانب الأيمن.

عمق التركيب: من 80 م حتى 108 م.

وصلة إطالة 25 م، رقم الصنف 13595000

طعم الملحقات 22 م (عدداً لا يكون الحد عميقاً بما يكفي).

رقم الصنف 13593000 / 13597XXX / 13596XXX
13597000 / 19427000 / 97407XXX / 98860000

يمكن تركيب الجسم الرئيسي للوحدة وفقاً لطرق البناء انظر أمثلة التركيب صفحتي 91 و 92.

- A التركيب على حائط مباشر
- B التركيب على الحائط المباشر بجوابط تركيب قابلة للضغط طولها 10 م.
- C التركيب على نظام حمامات.
- D التركيب على حائط مجوف
- E التركيب على حائط من الطوب
- F التركيب باستخدام طقم الانثيثت #96615000.

يوجد بدءاً من صفحة 96 أمثلة للتركيب بمقاسات وطرق عمل بعض الوصلات، يوجد شبح للرموز المستخدمة على الصفحات 86 و 87.

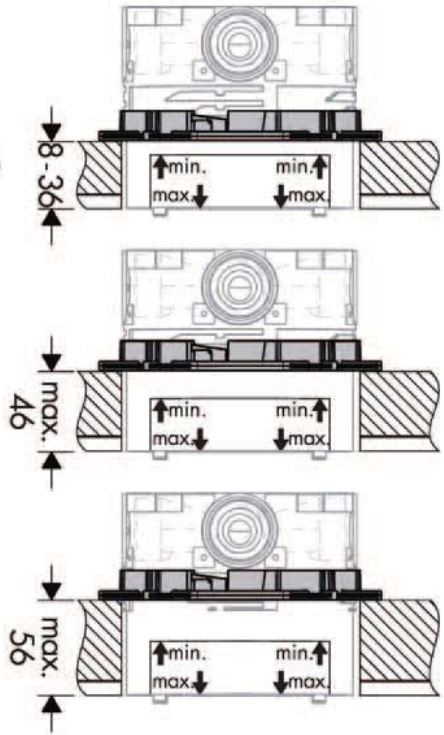
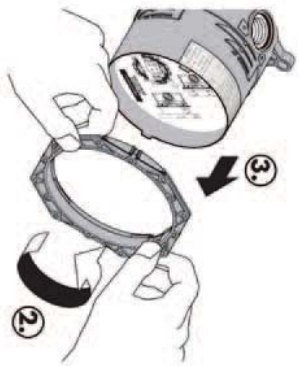
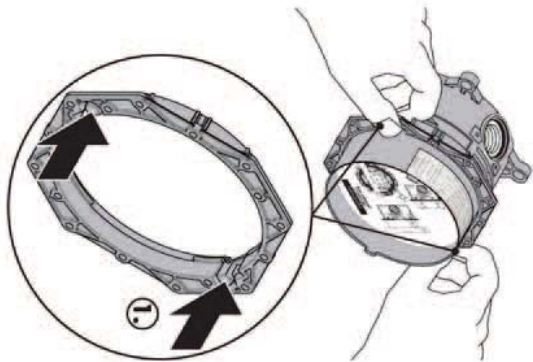

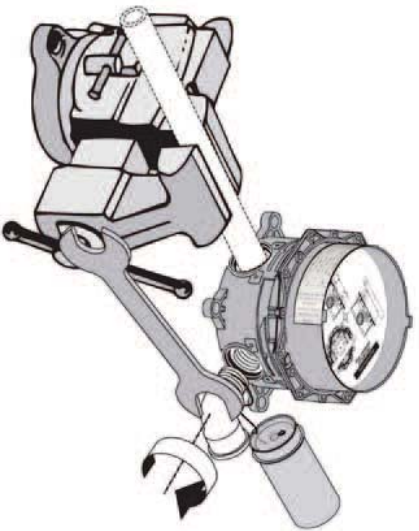
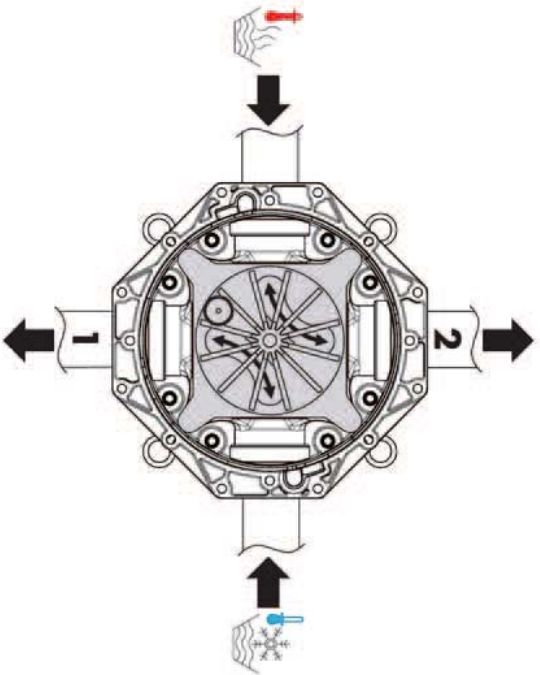

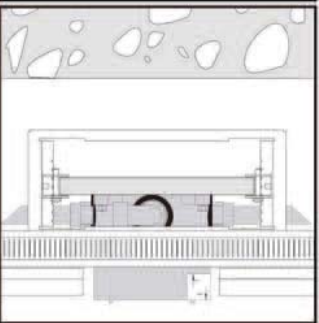
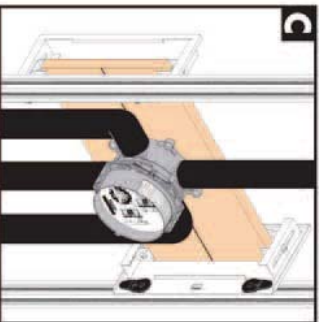
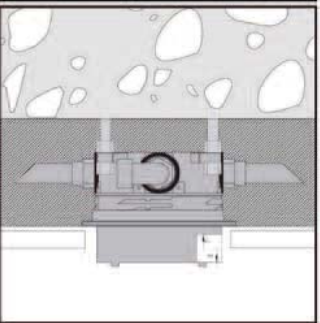
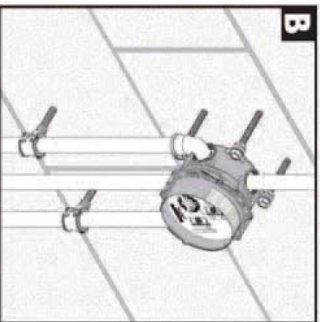
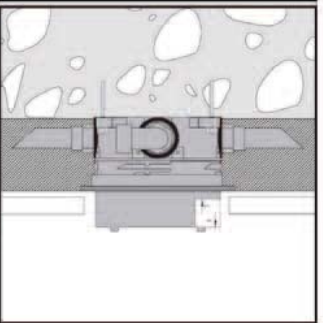

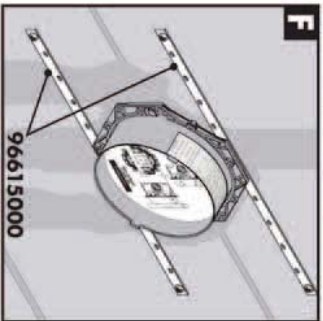
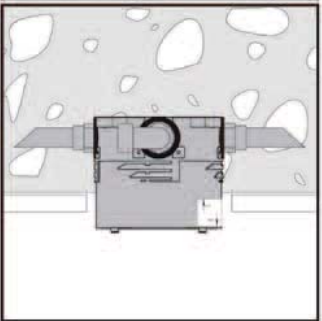
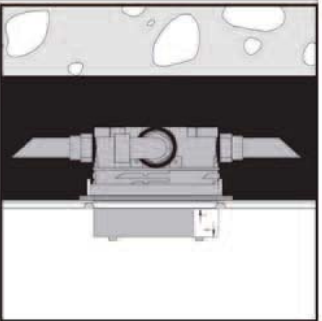
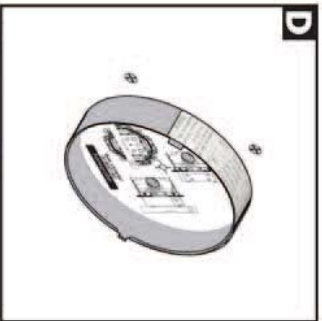

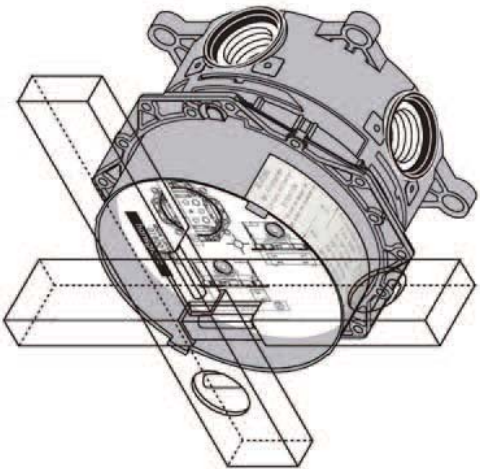
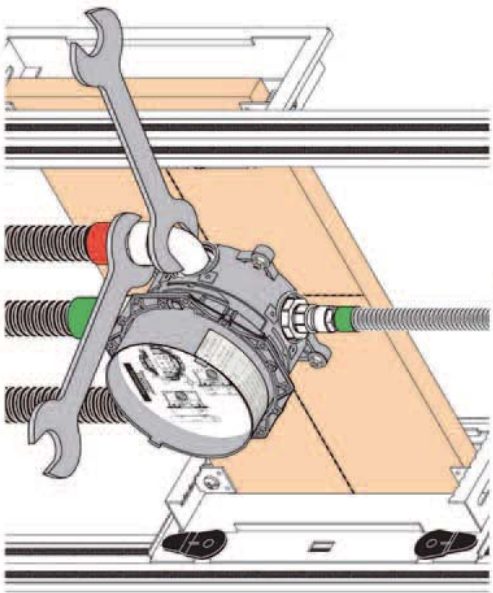

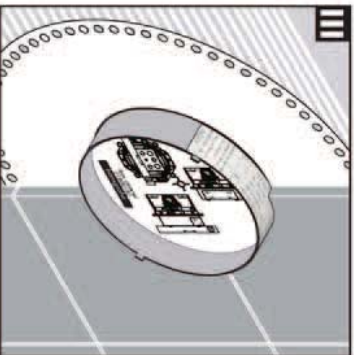
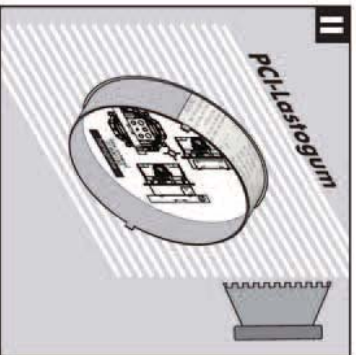
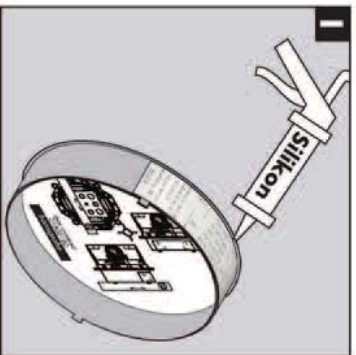

Prüfzeichen / Classification acoustique et débr / Test certificate / Segno di verifica / Marca de verificación /
 Keurmerk / Godkendelse / Marca de control / Znak jakości / Zkušební značka / Osvědčení o akústice / 检验标
 記 / Знак технического контроля / Vizualiel / Koelustusmerki / Testsigill / Bandyne pažyma / Označka testování /
 Kontrol izavei / Certificat de testare / Τύπος έγκυρου / Prekuzni znak / Kontrollsertifikaati / Pārbaudes zīme / Испити
 знак / Провемерке / Контролни знак / Шенга с контролли / 检测标志

PAIX **DVGW** **SVGW** **WRAS** **KIWA** **ACS**

PA-IX 1 8989 / ID BP5615 X X X X X



iBox universal + Exafill

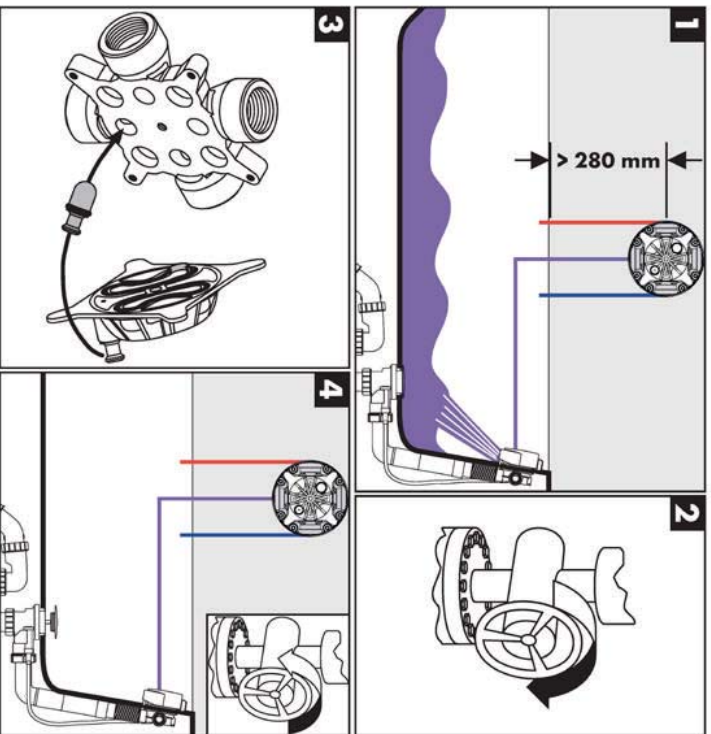
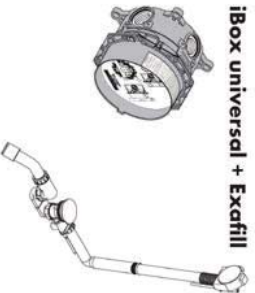

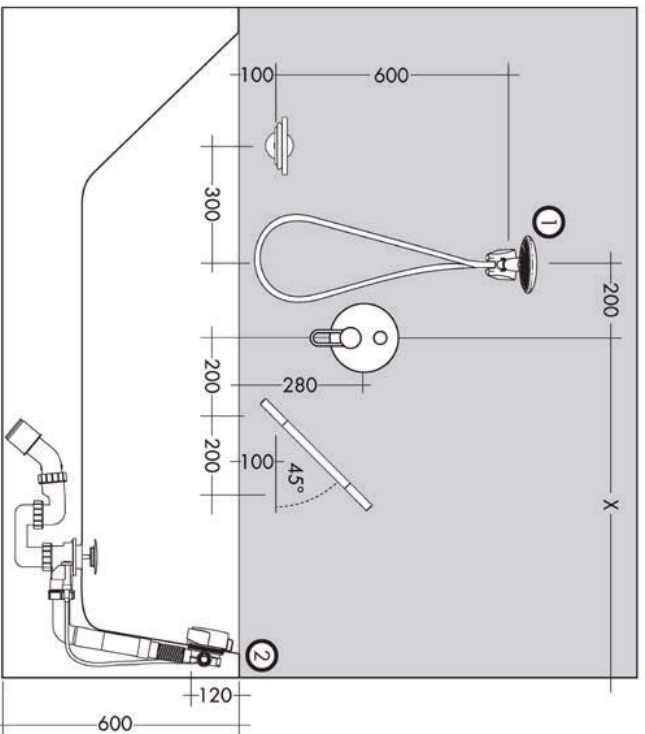
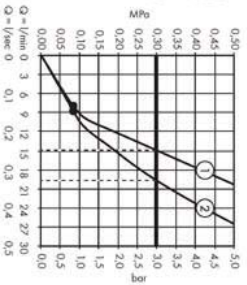

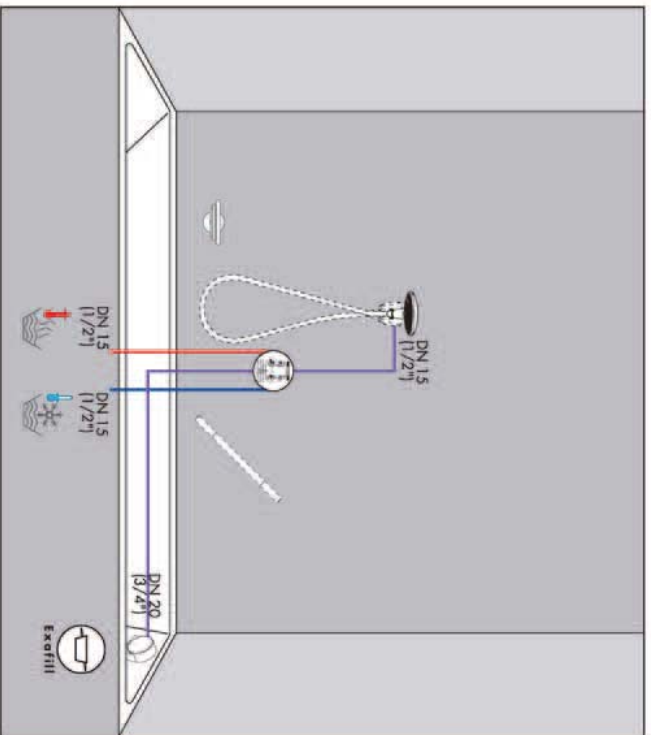

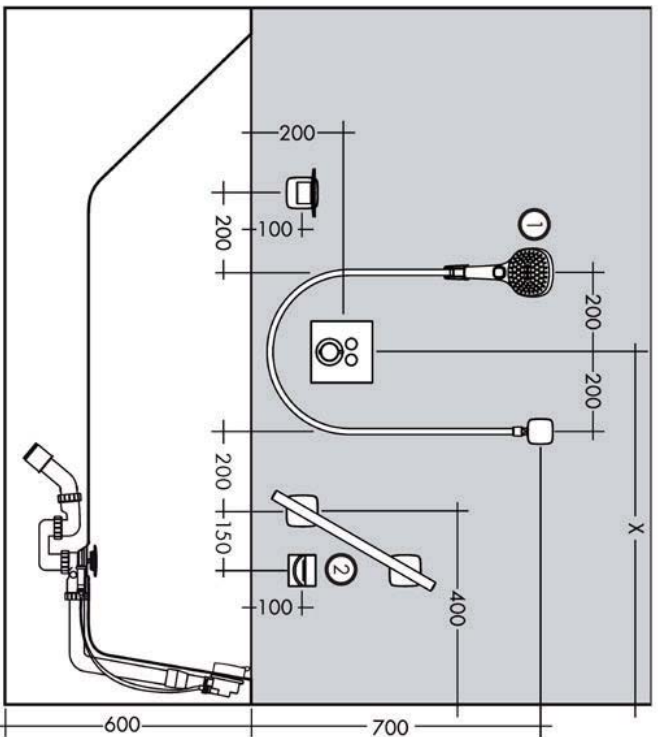
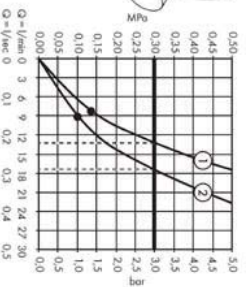
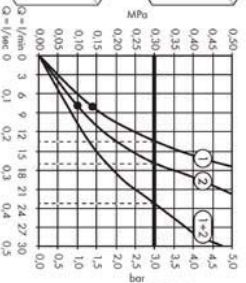

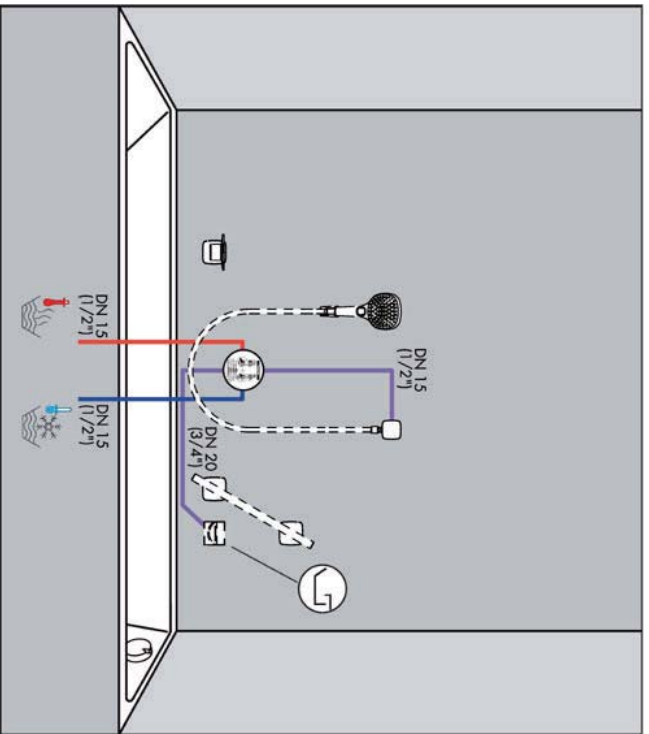
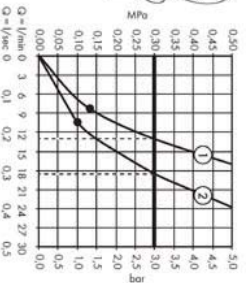

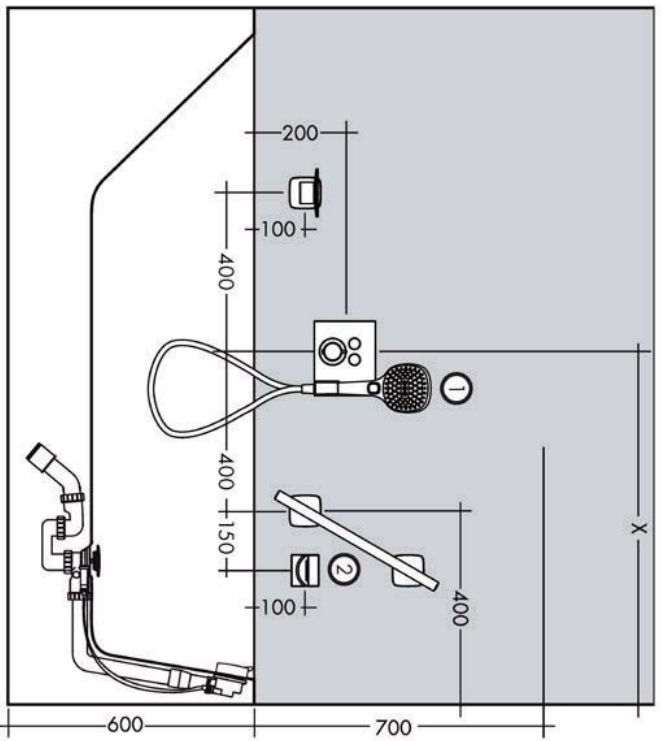
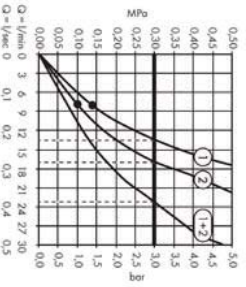

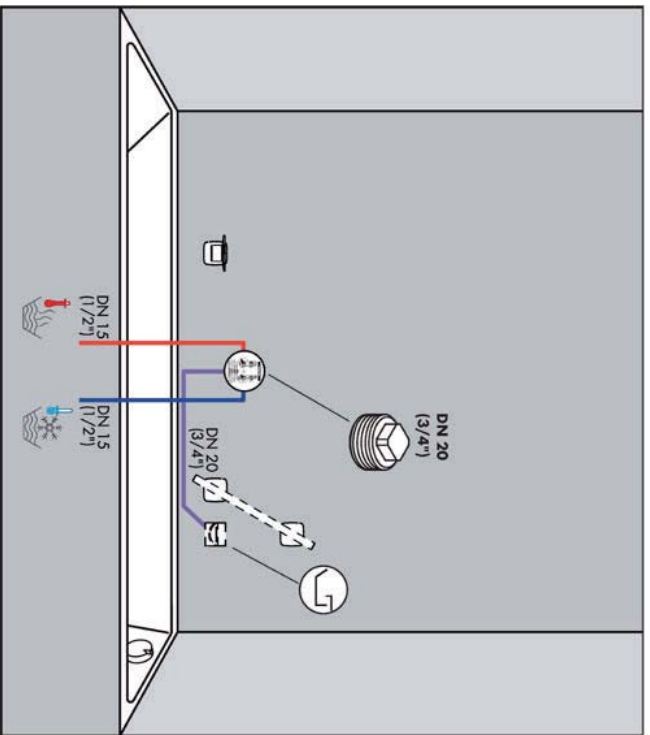

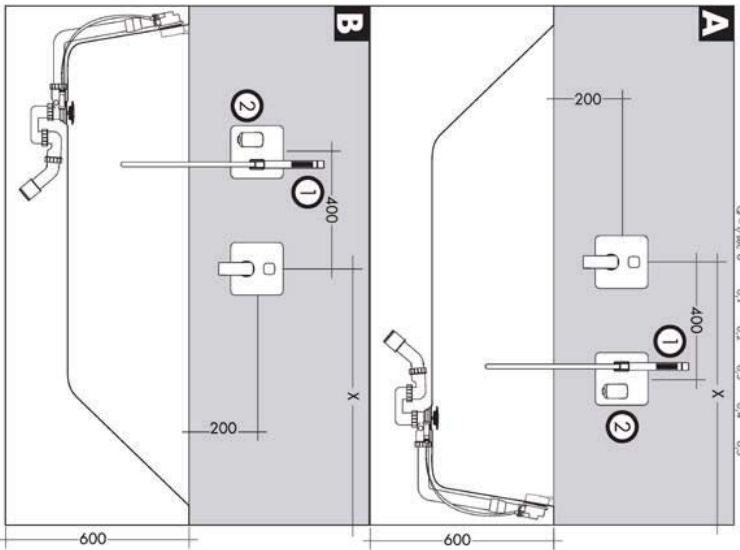
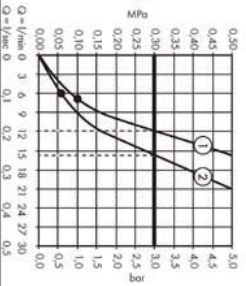

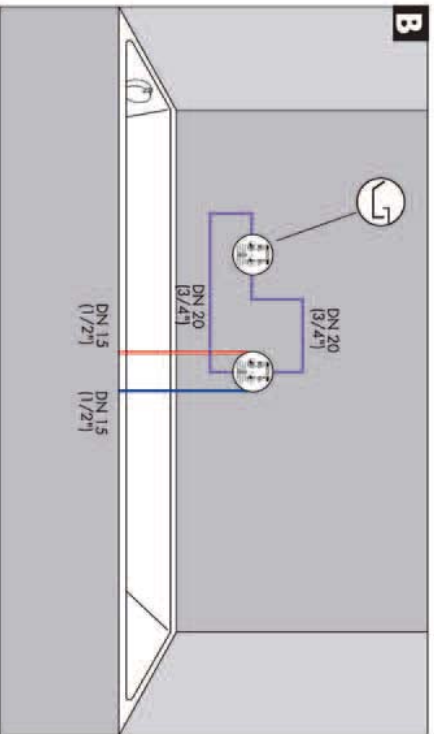
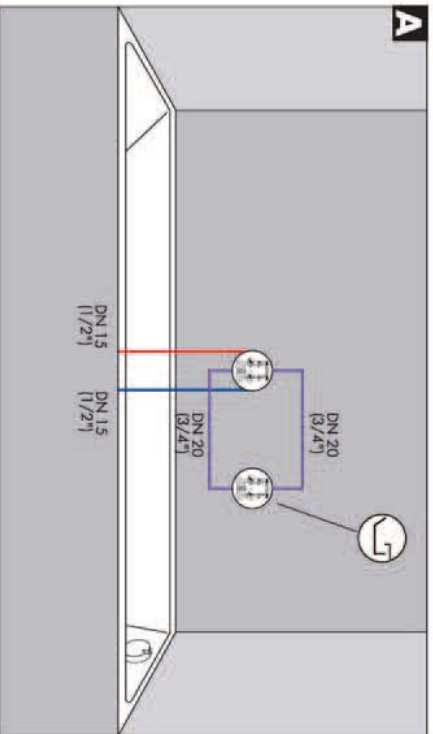

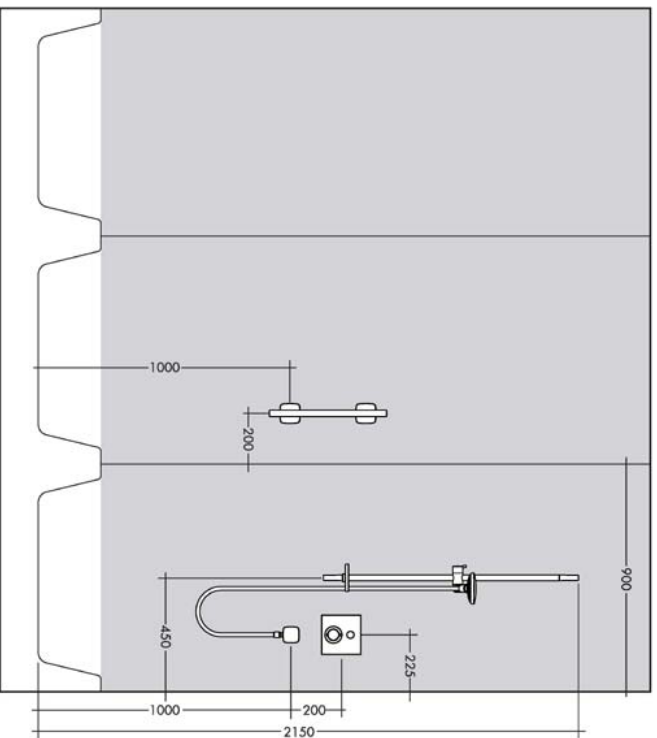
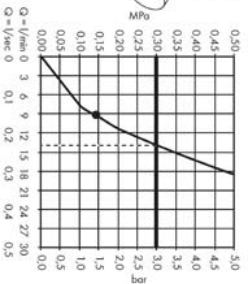
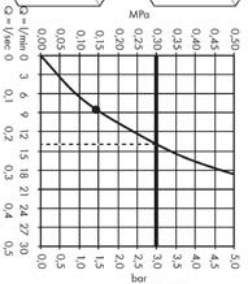
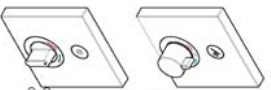

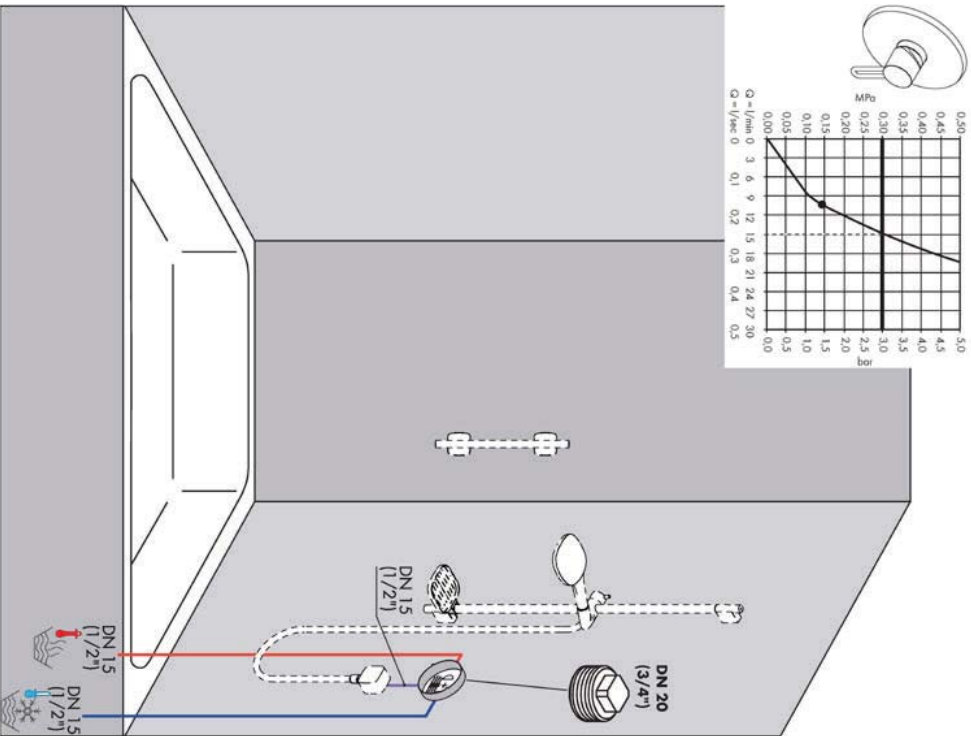

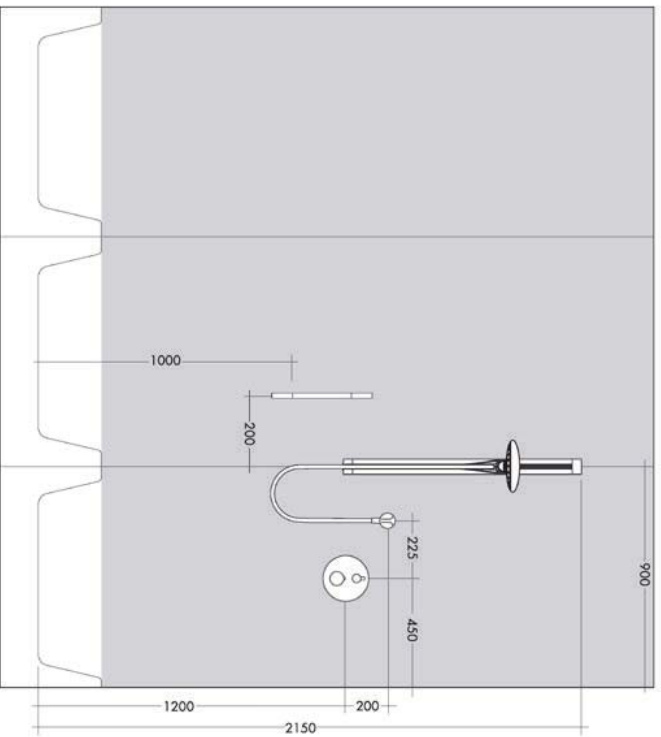
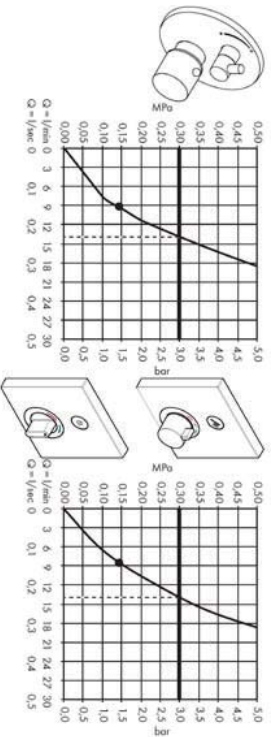

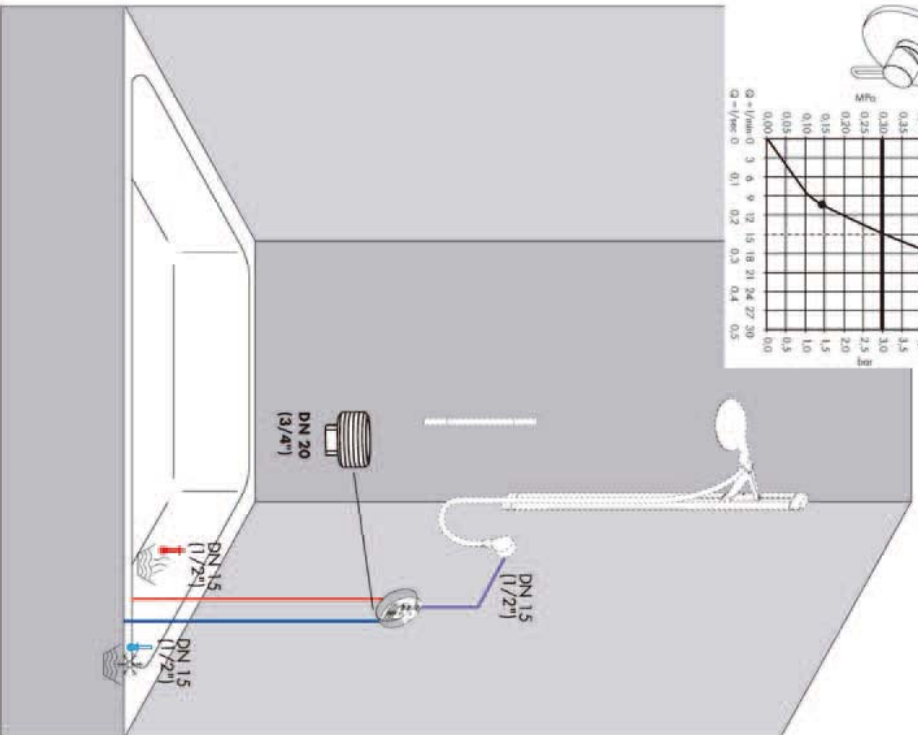
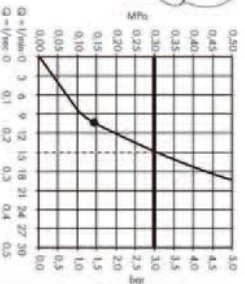

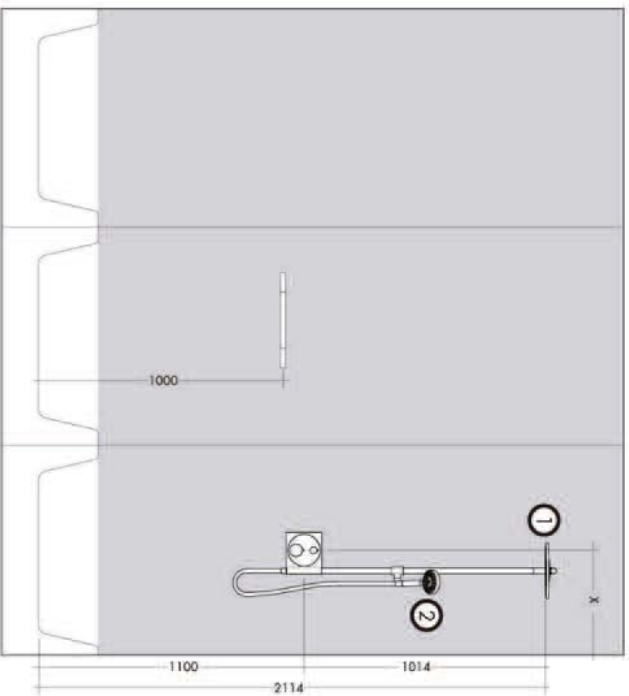
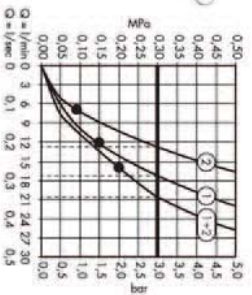

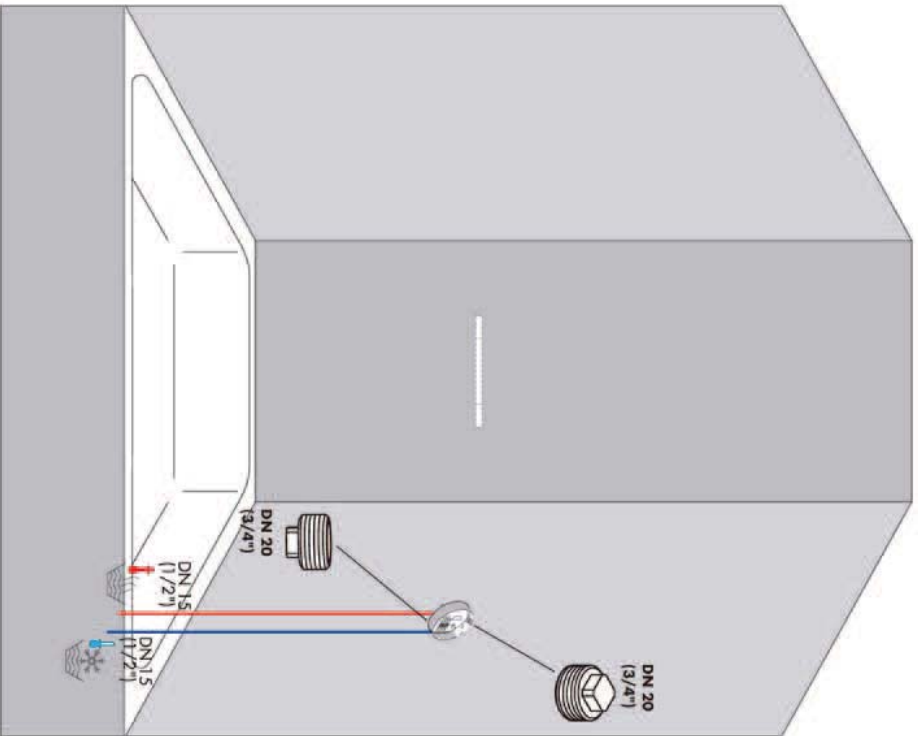

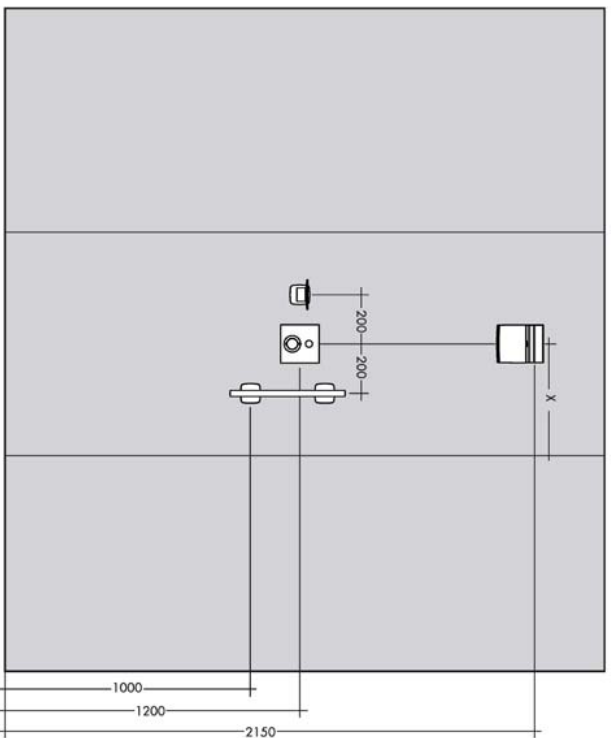
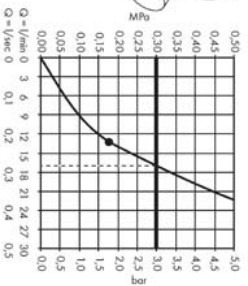
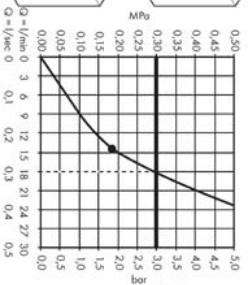

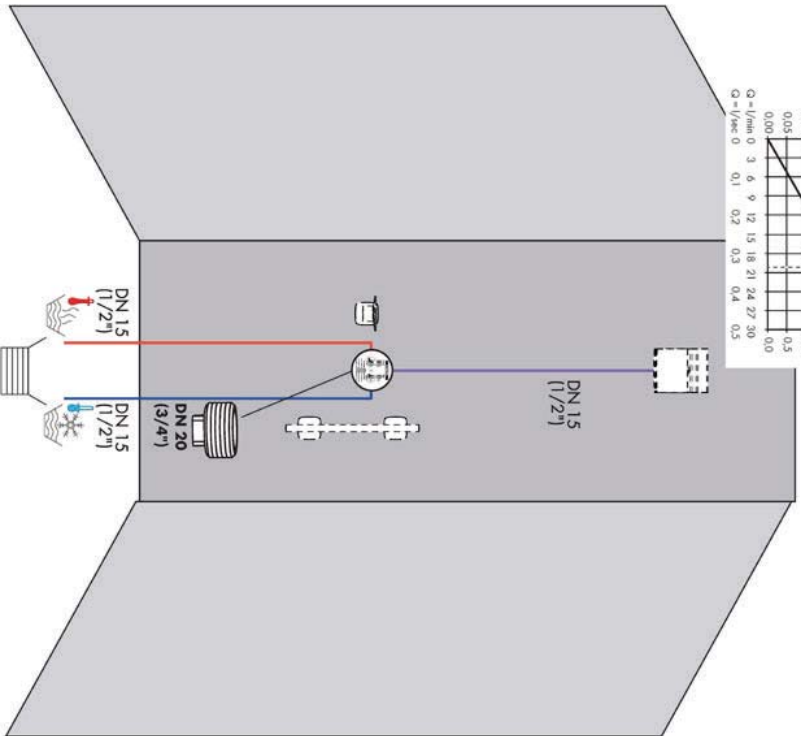
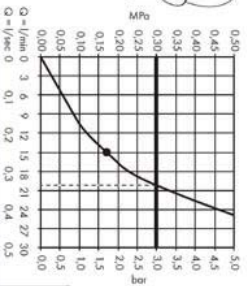

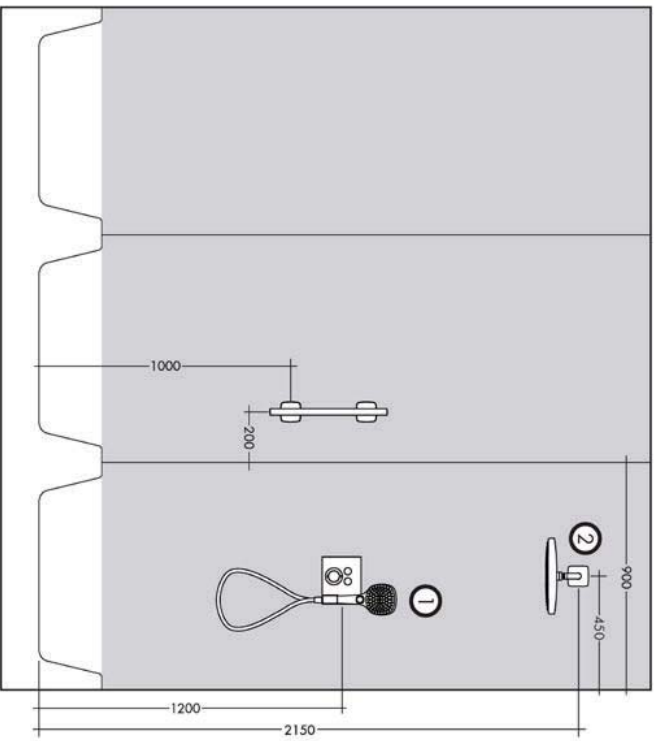
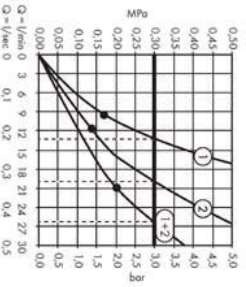

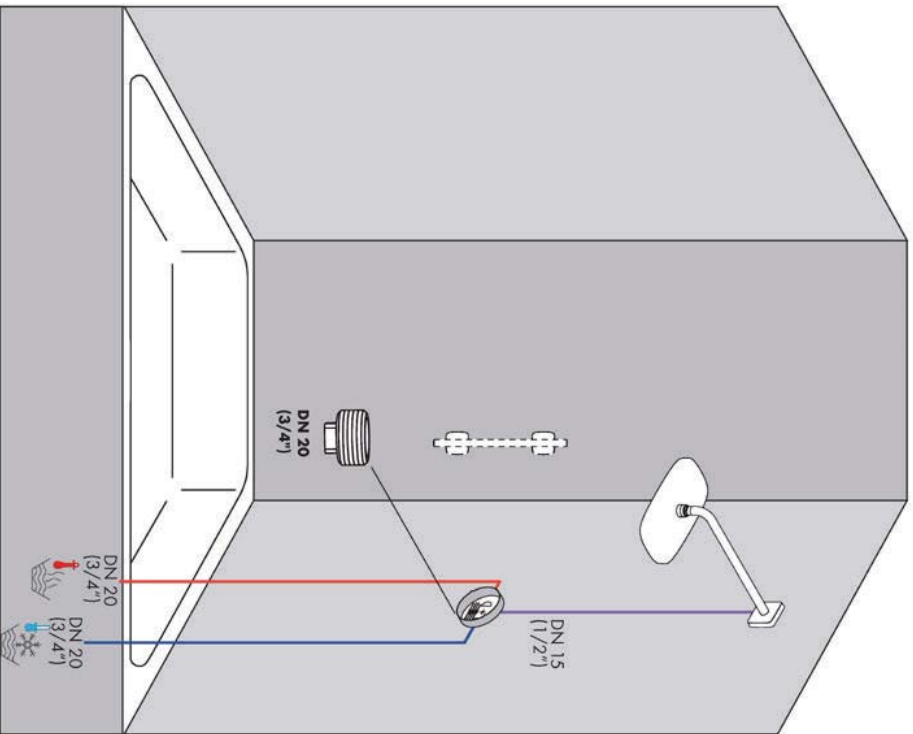

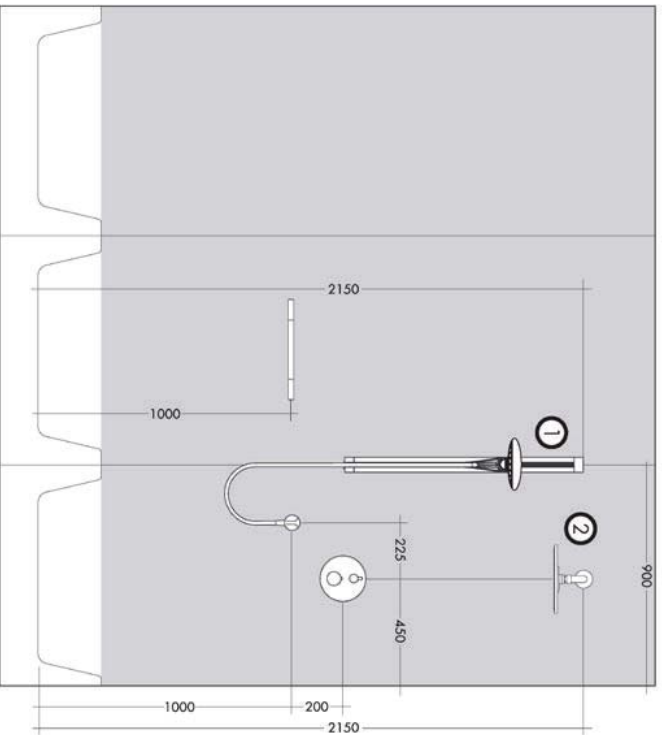
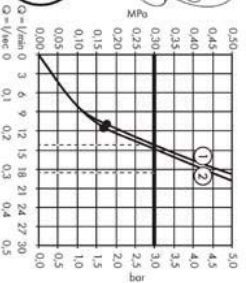
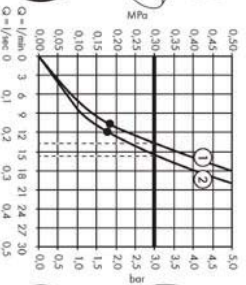

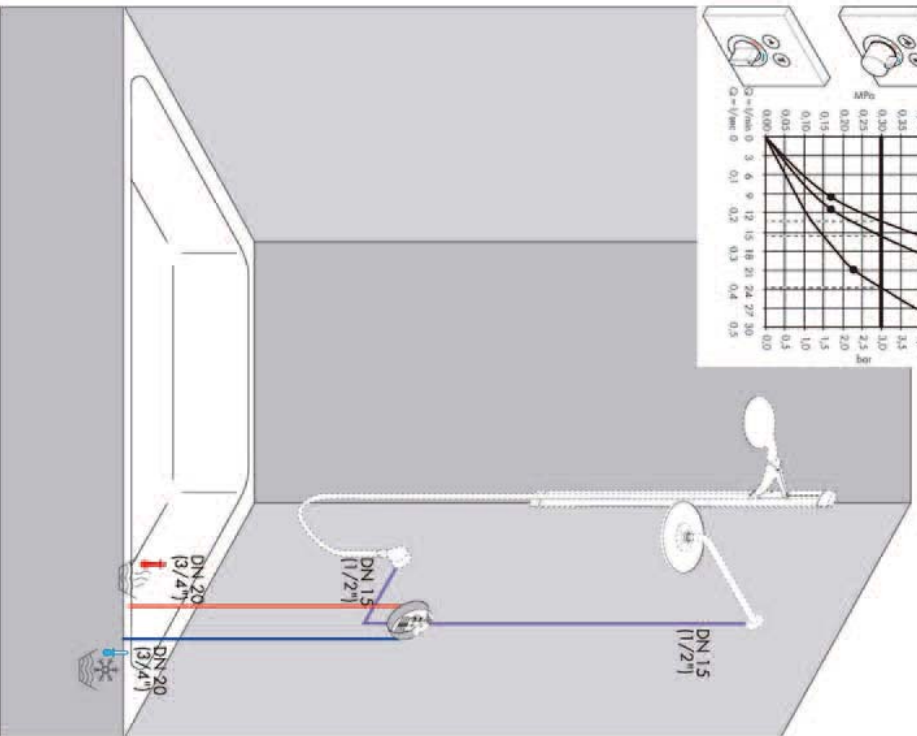
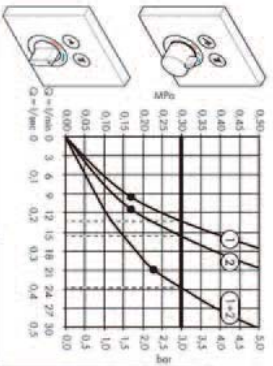

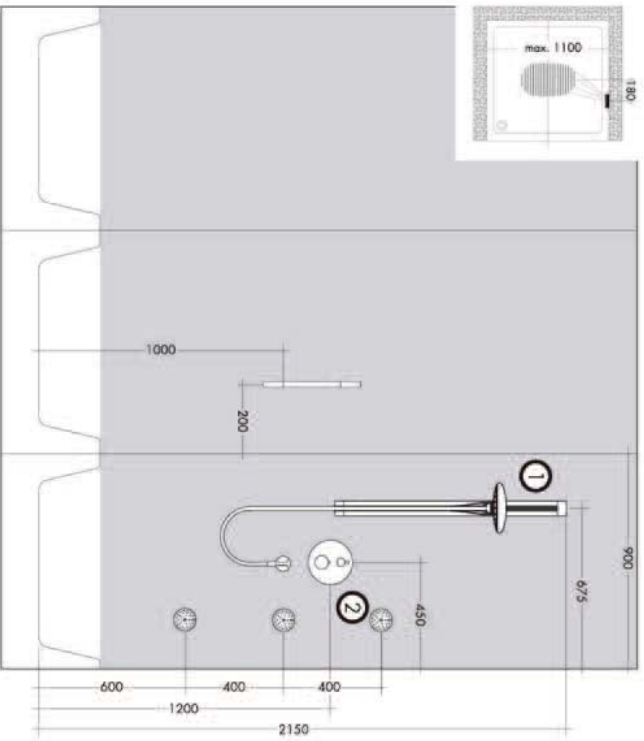
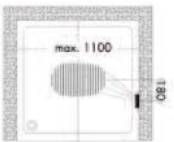
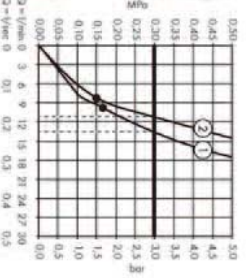
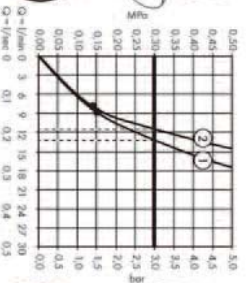

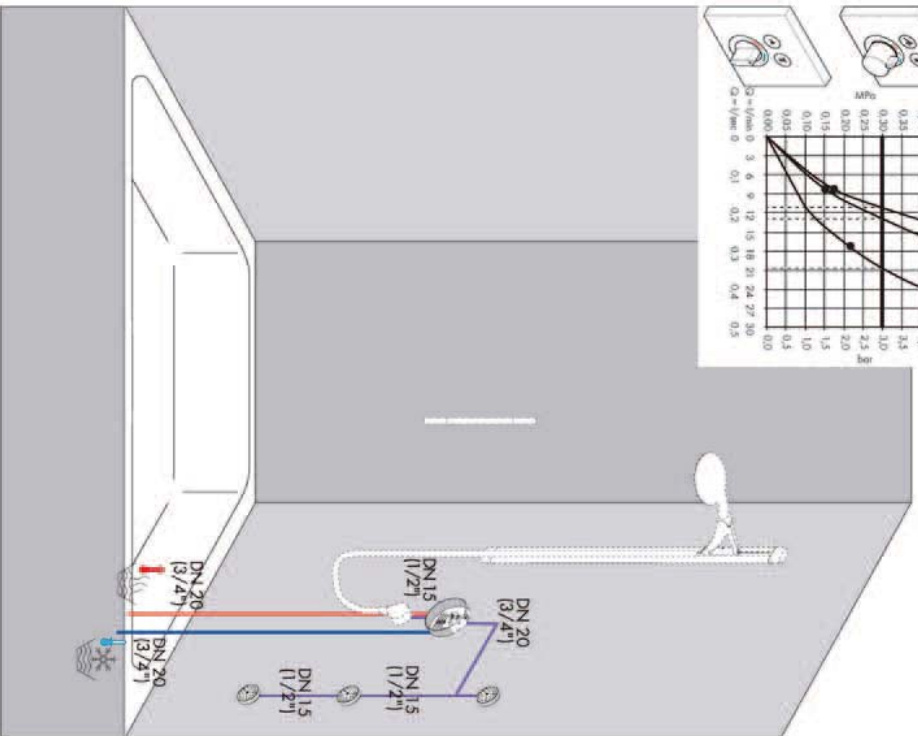
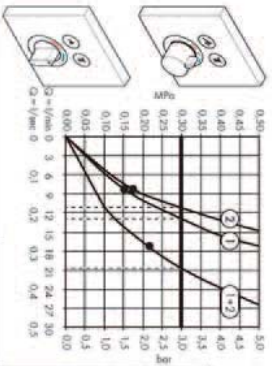

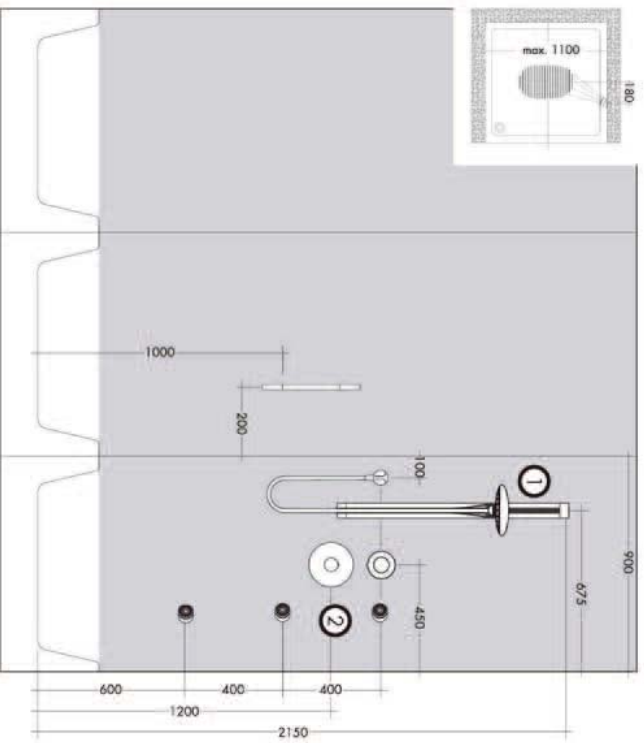
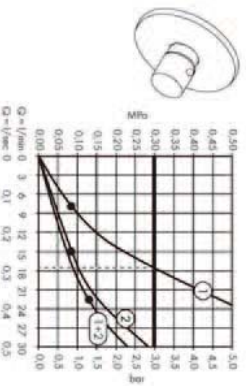

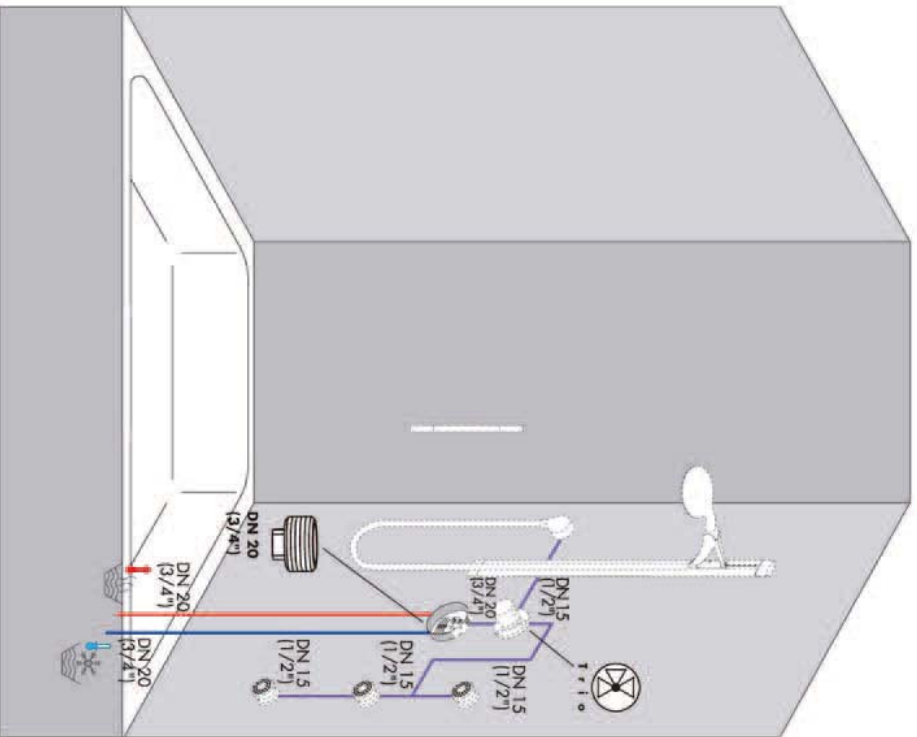

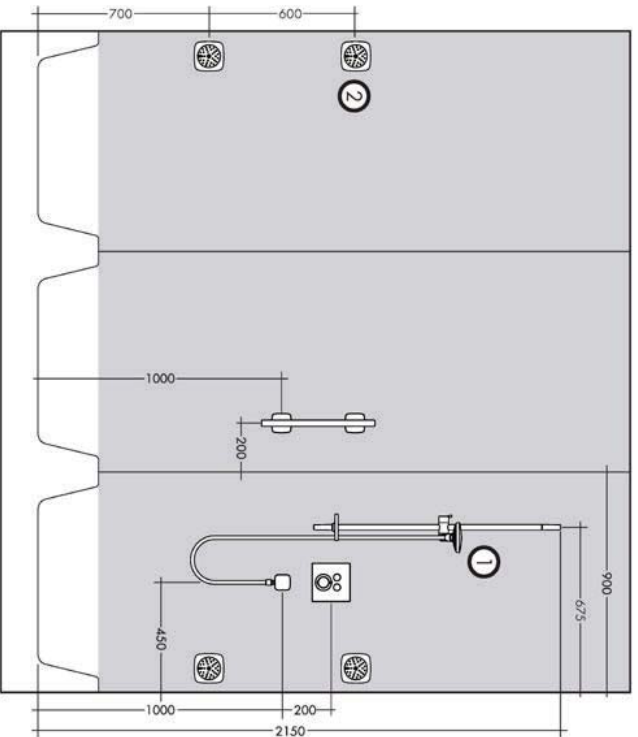
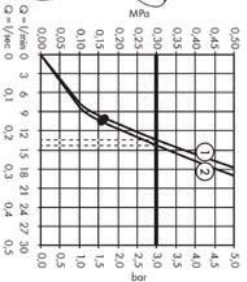
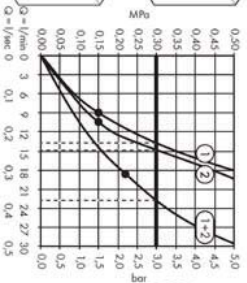

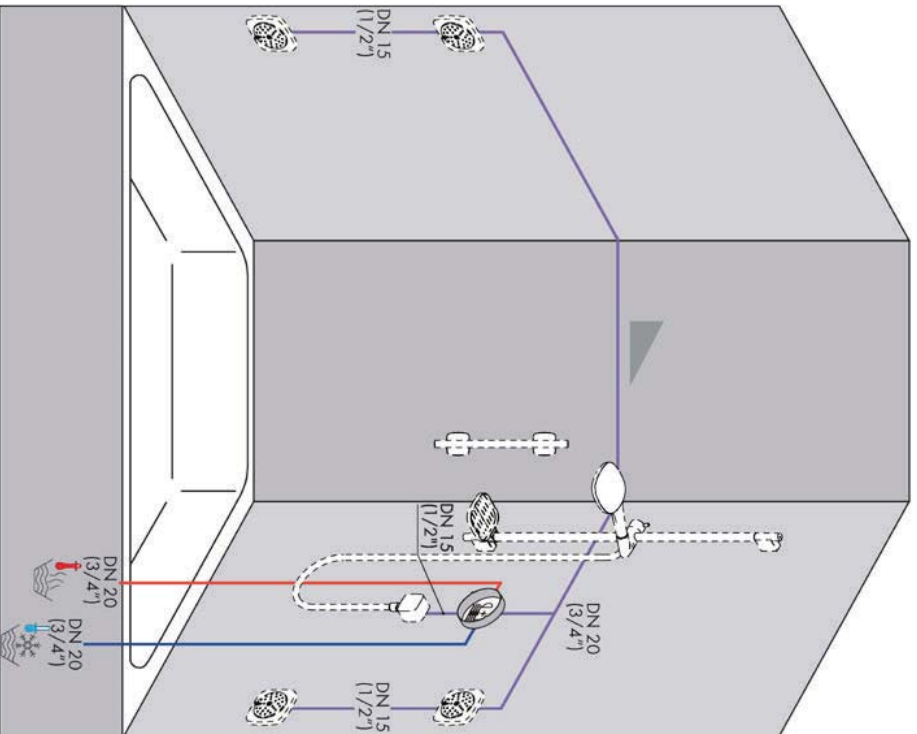

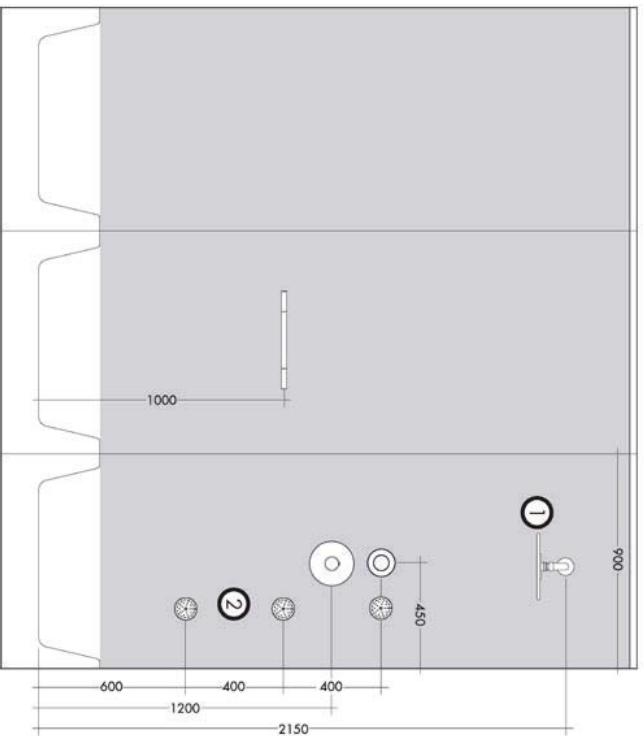
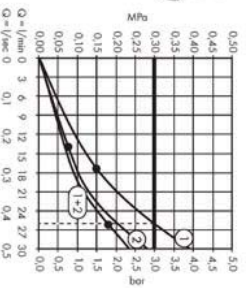

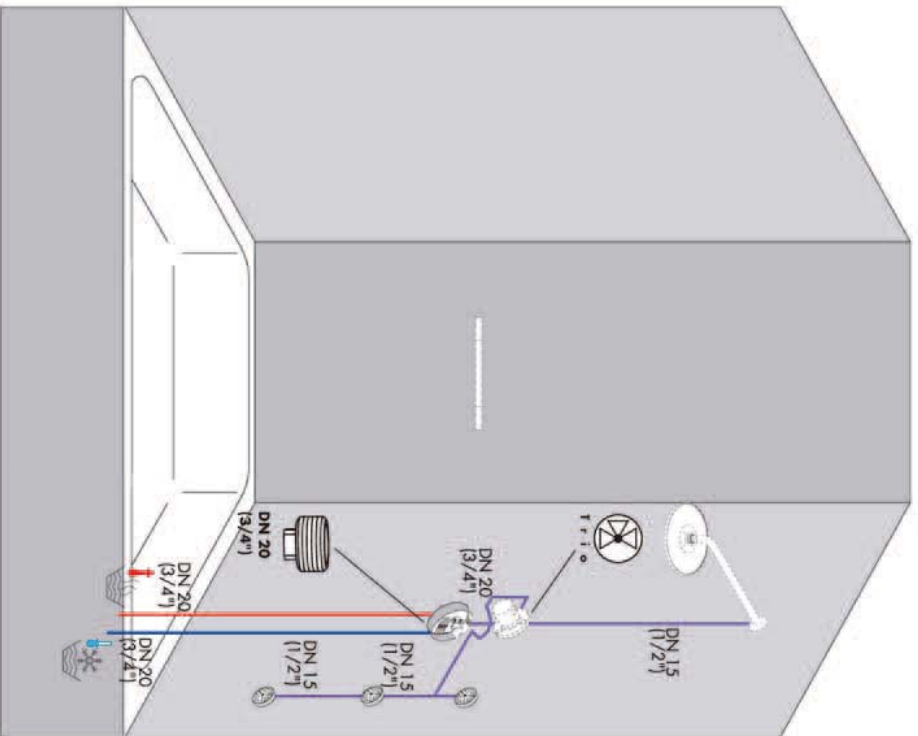

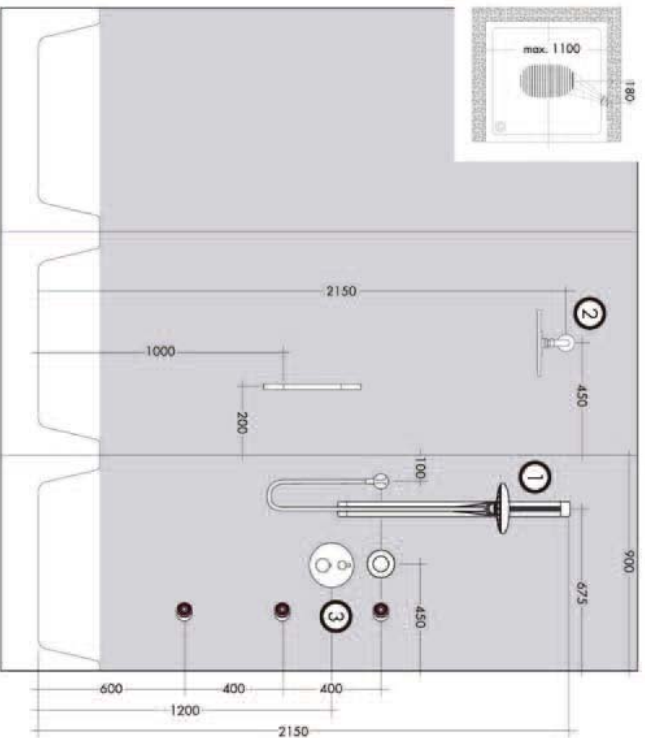
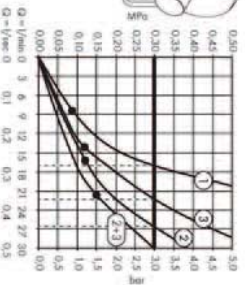
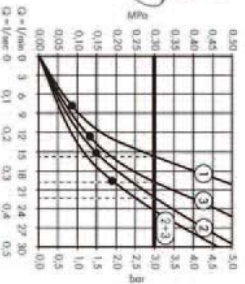

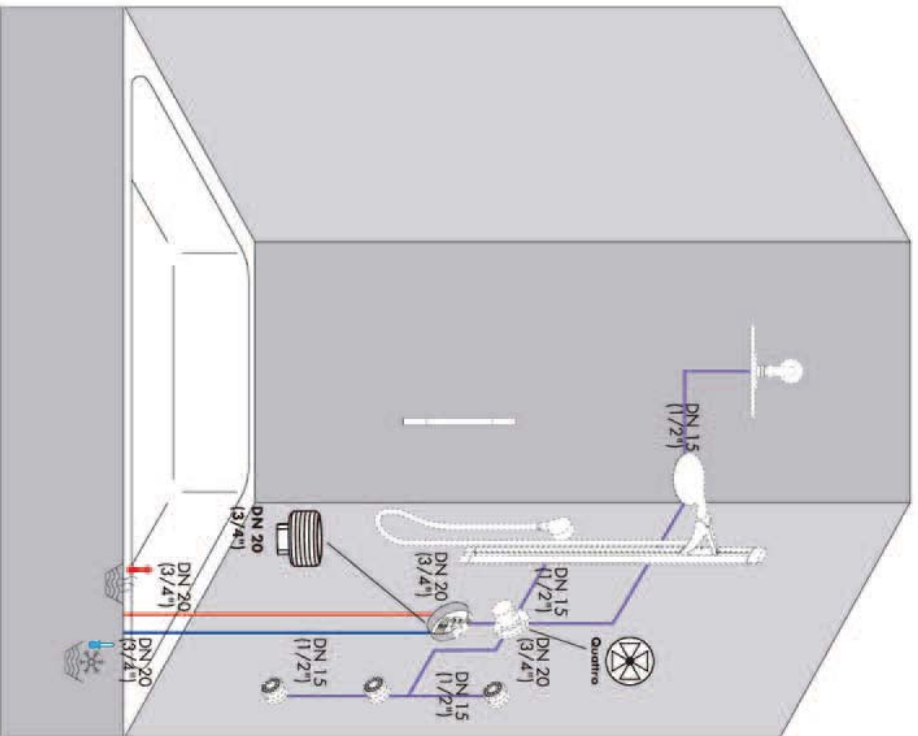

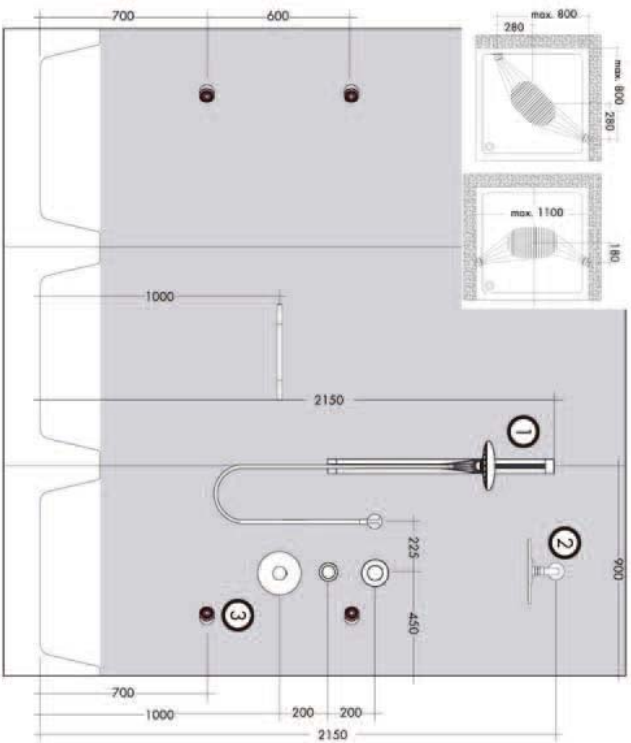
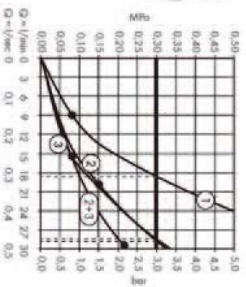

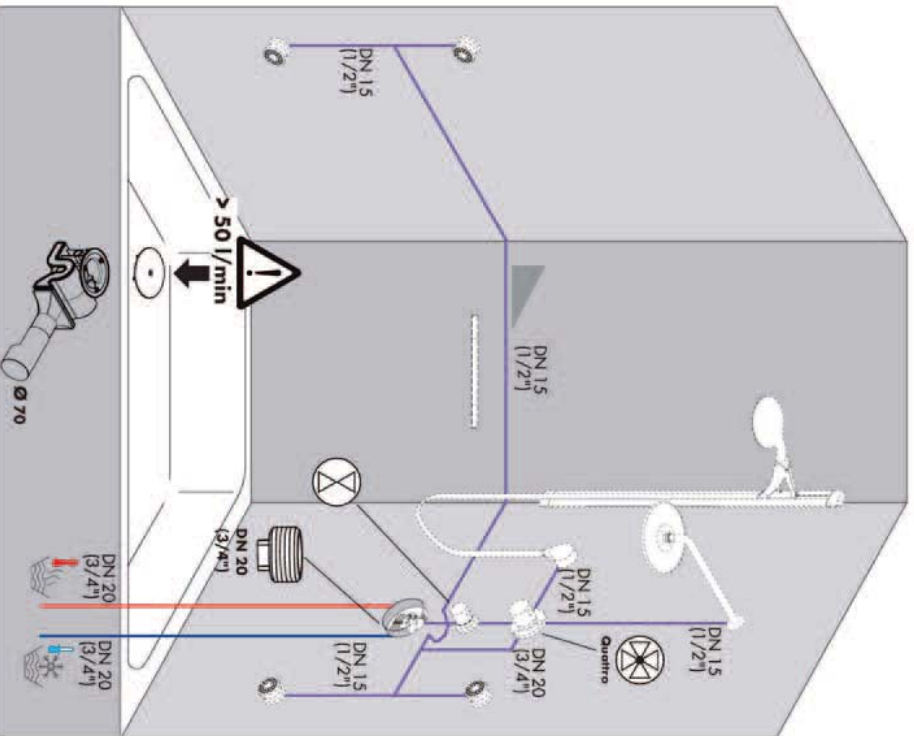



High
Flow

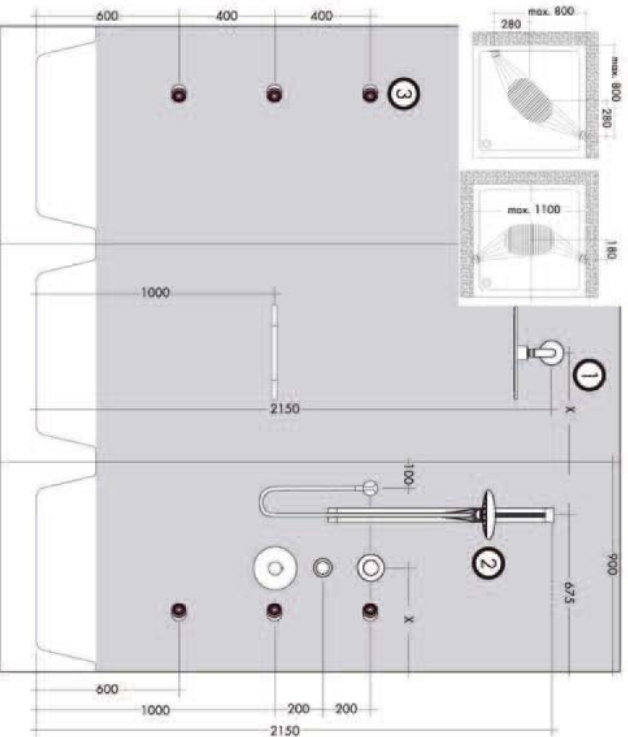
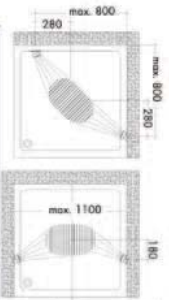
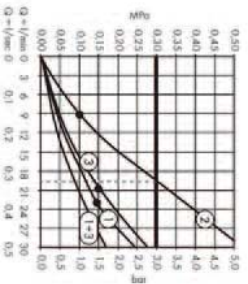

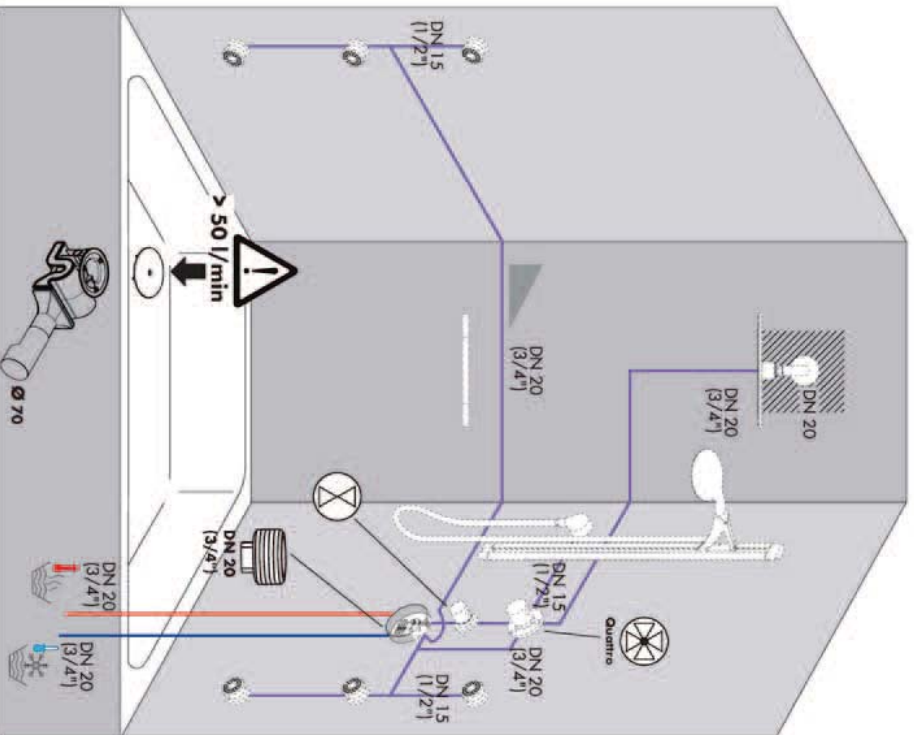



High
Flow

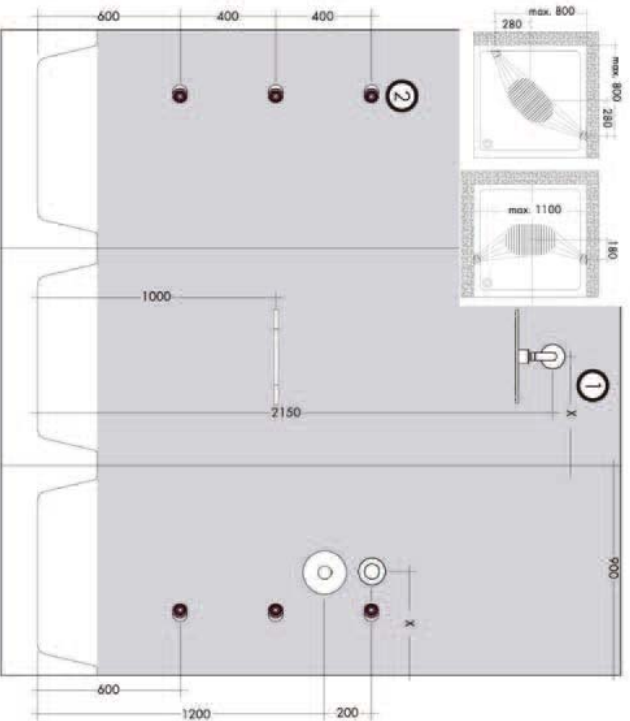
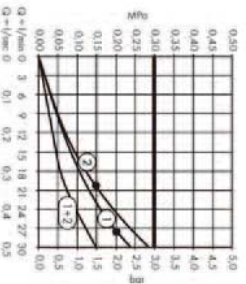



High
Flow

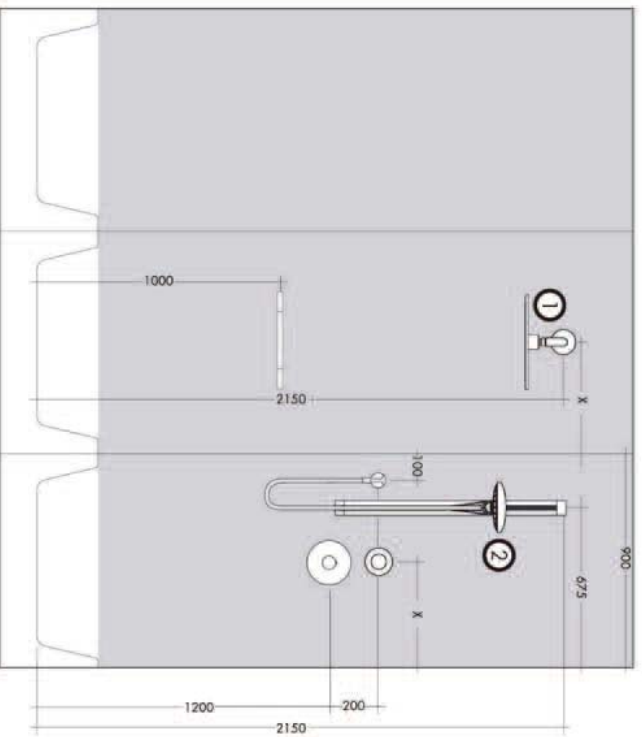
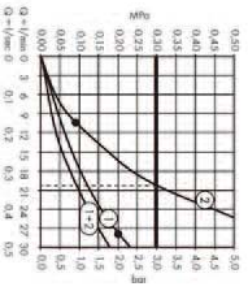

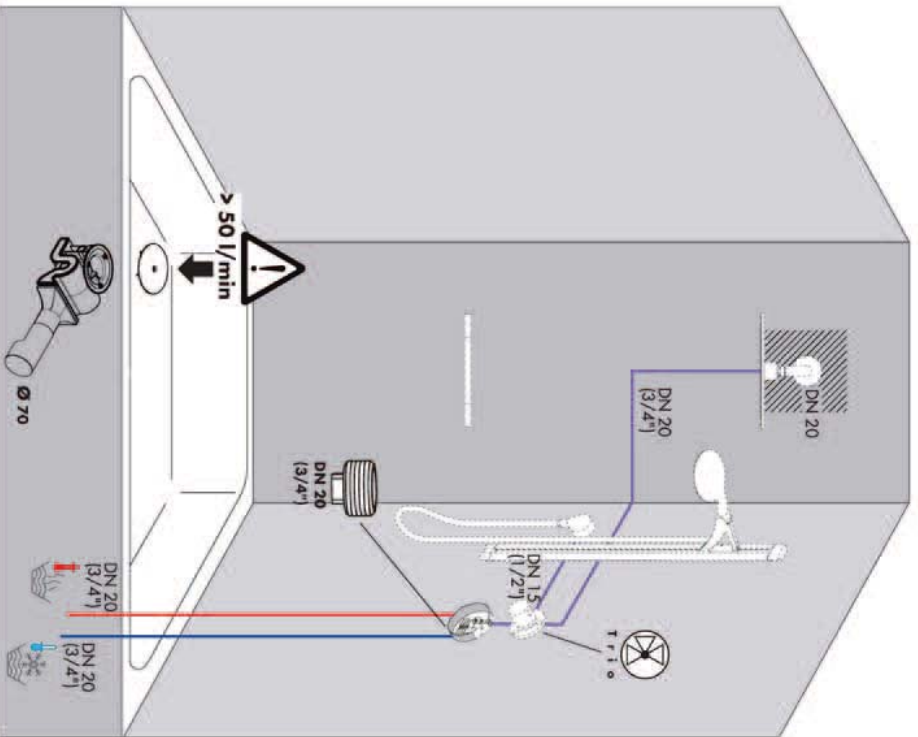



High
Flow

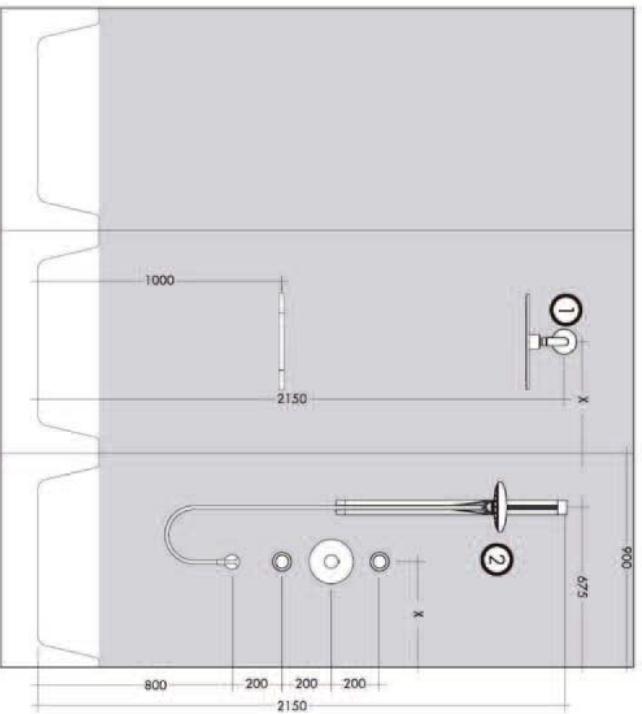
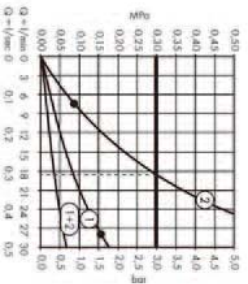

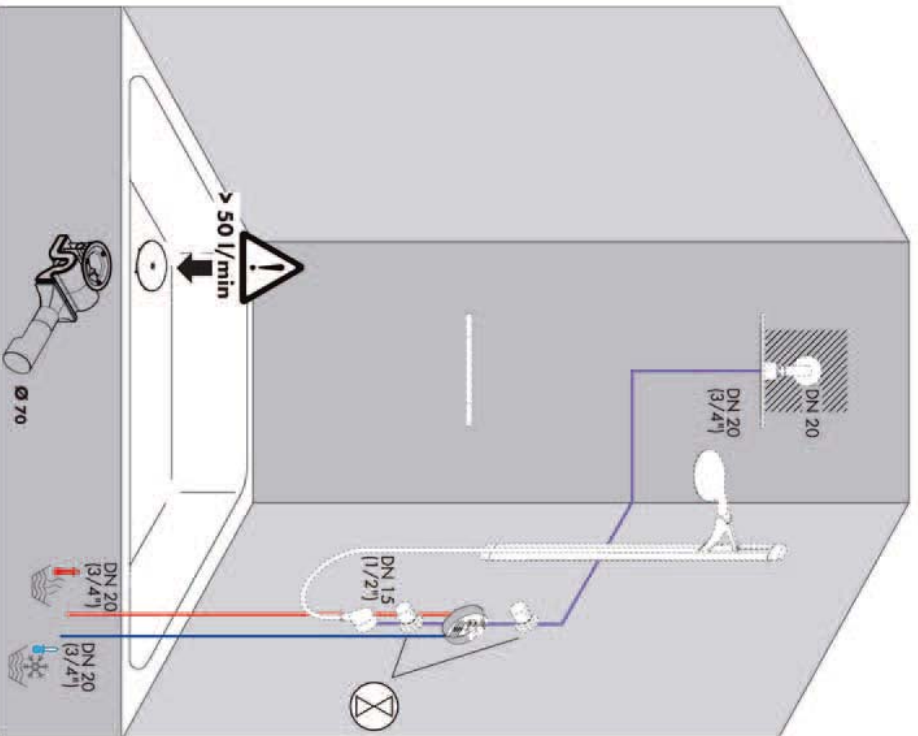



High
Flow

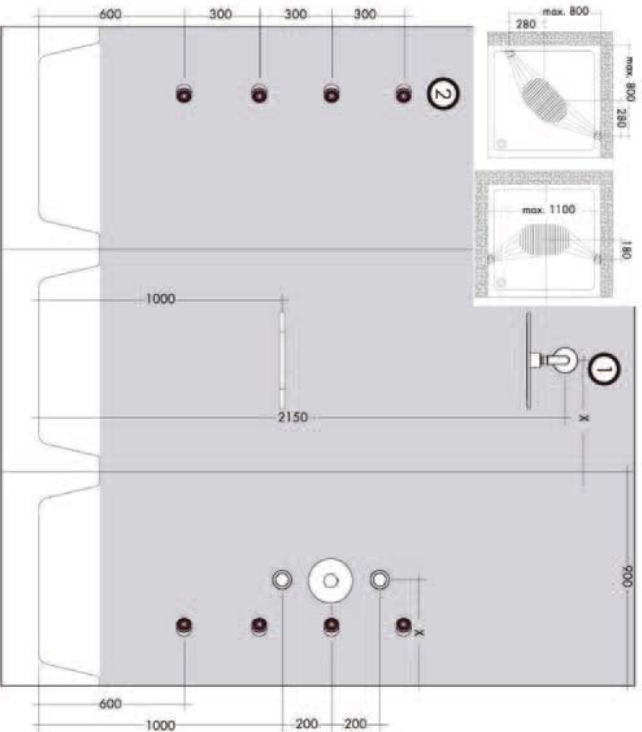
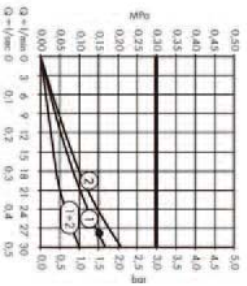



High
flow

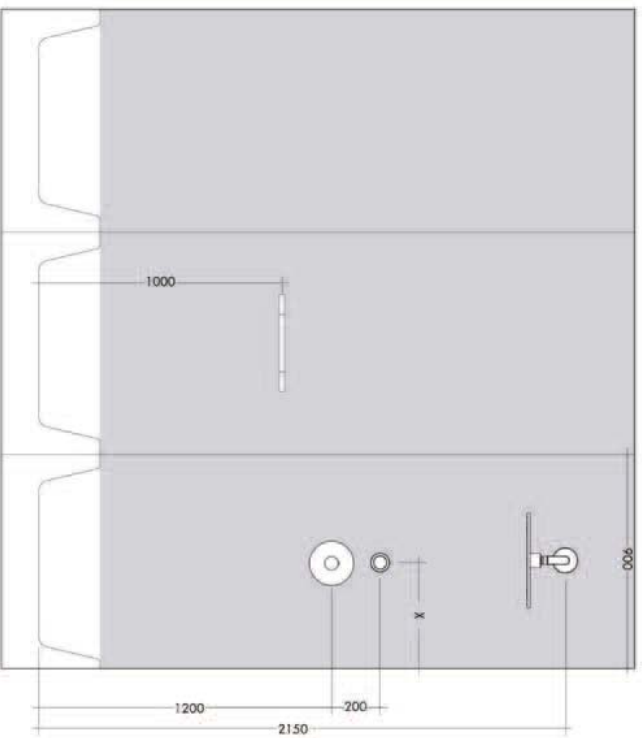
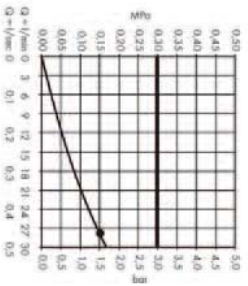

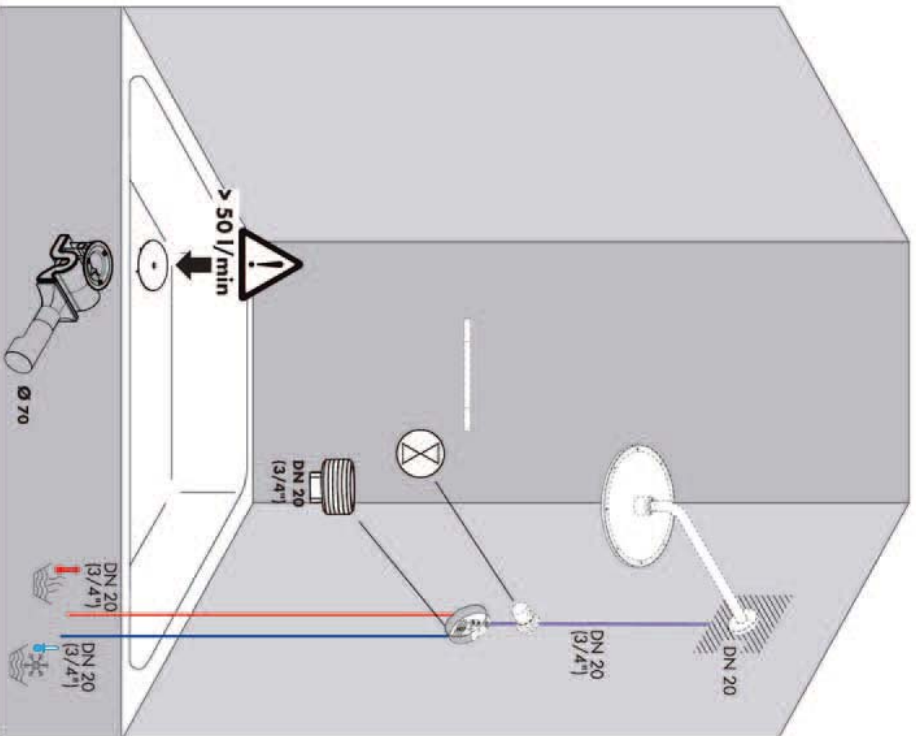

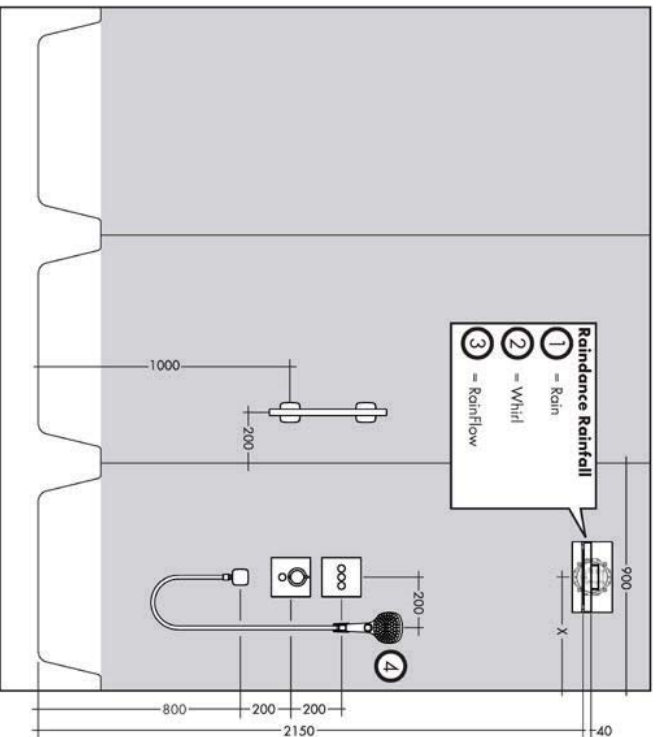
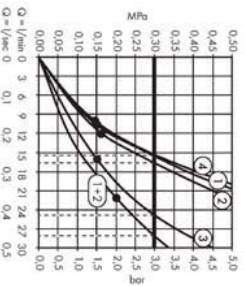

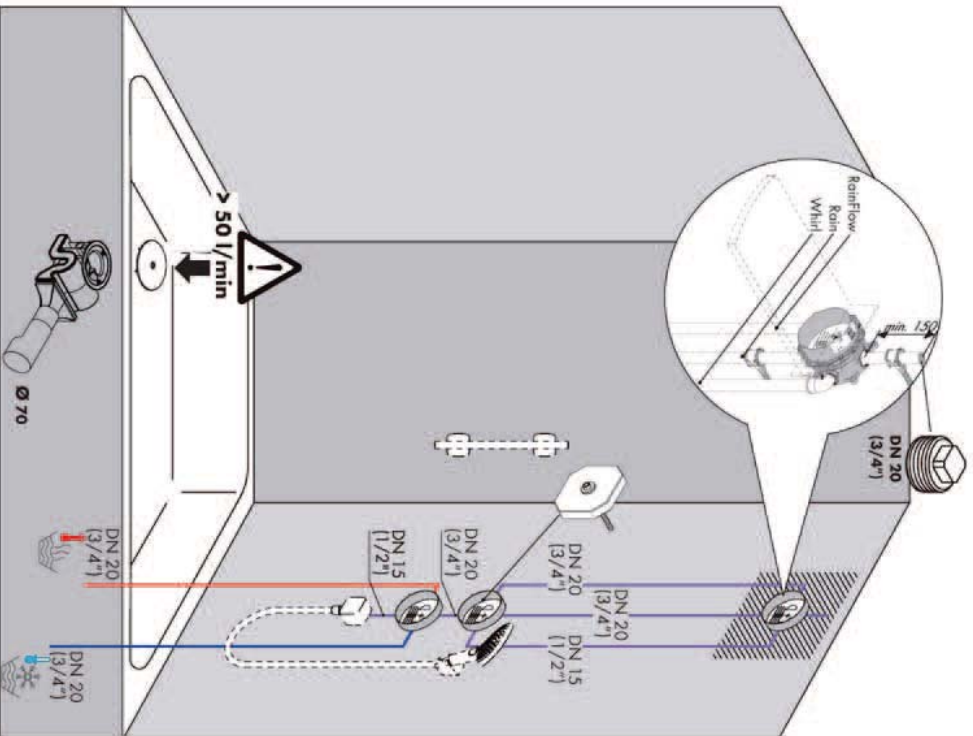



High
flow

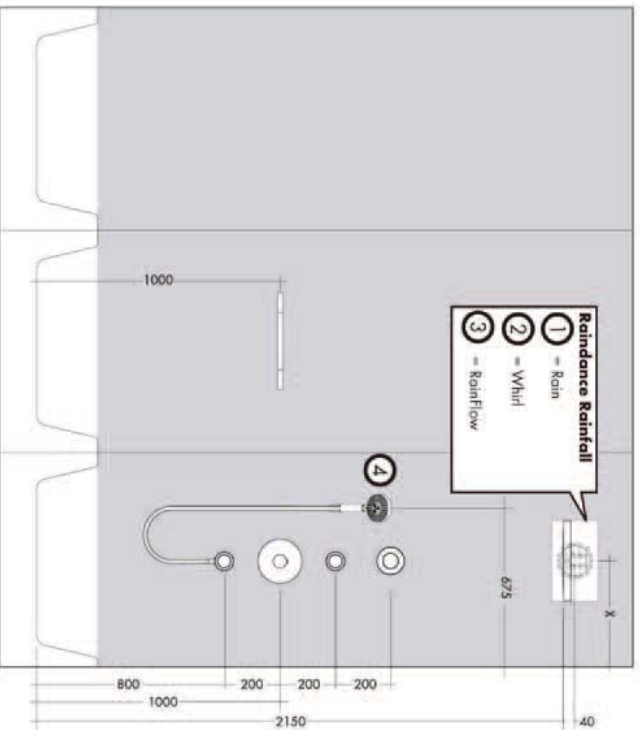
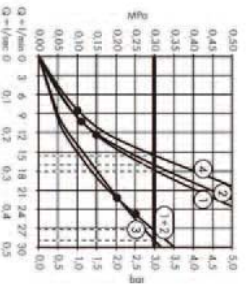

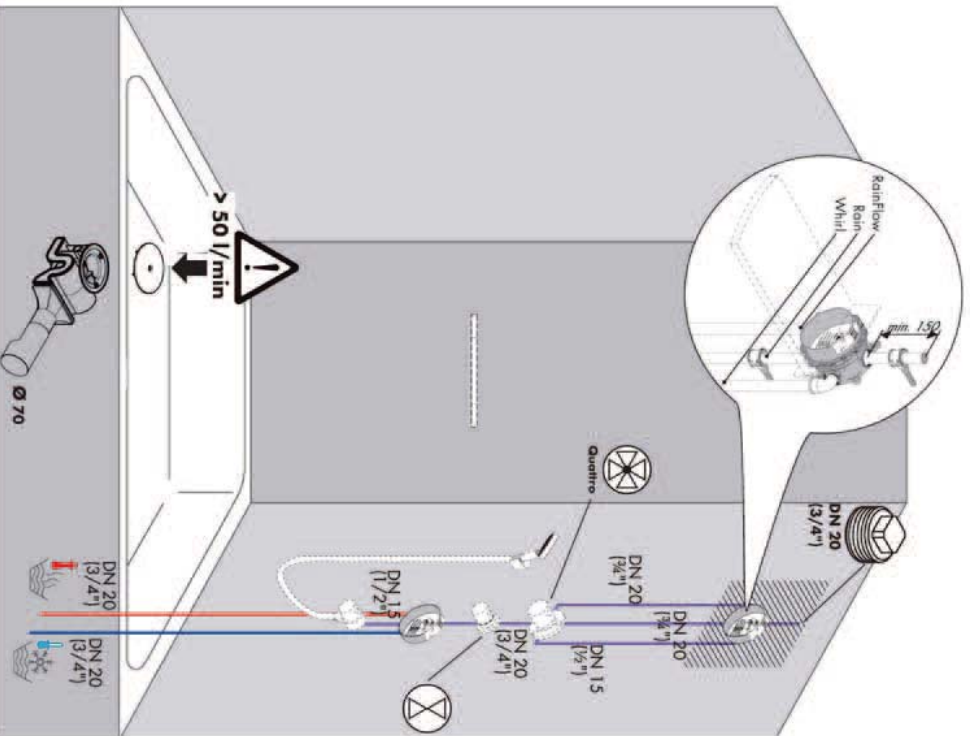

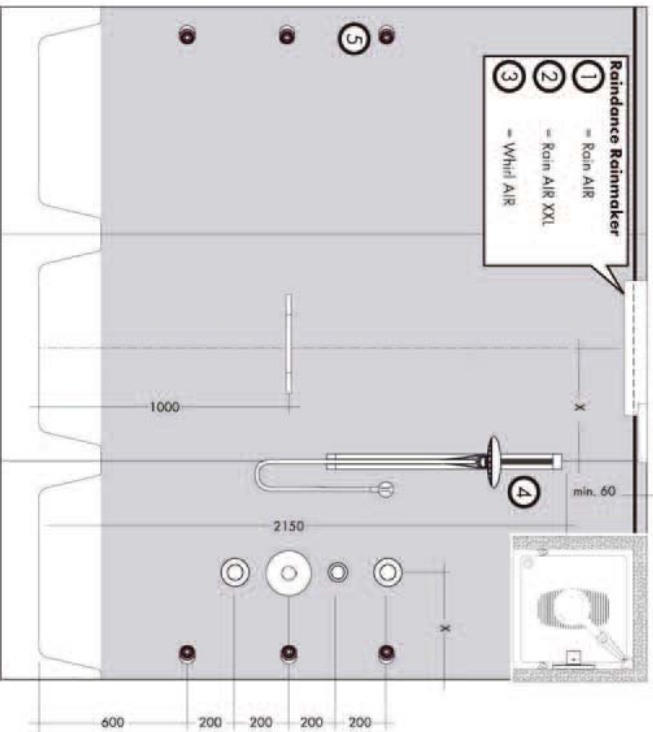
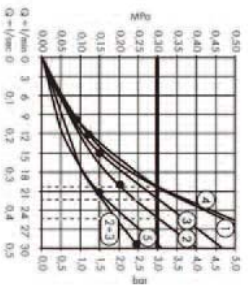

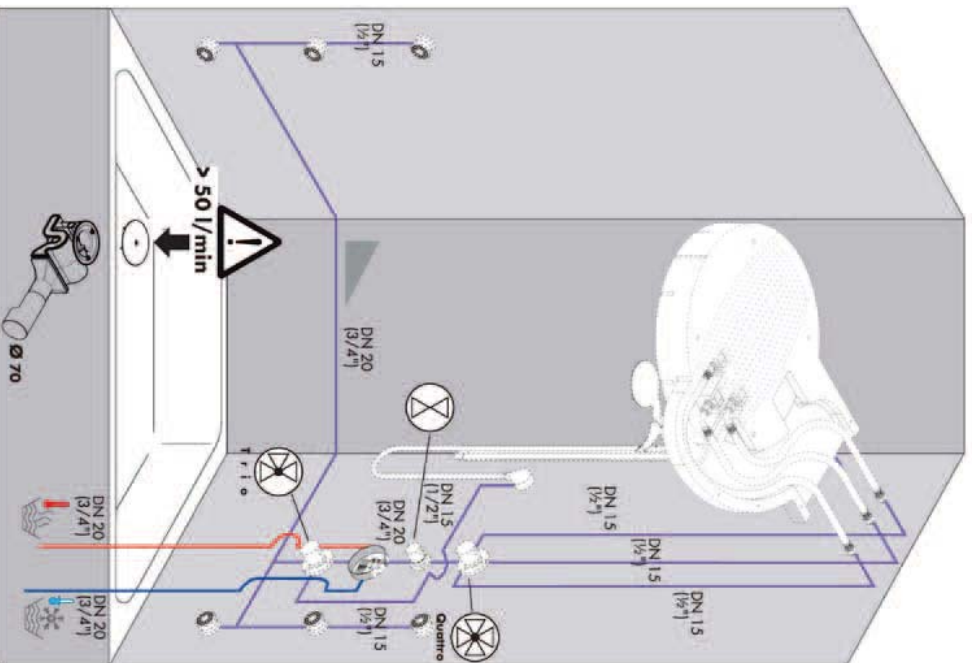

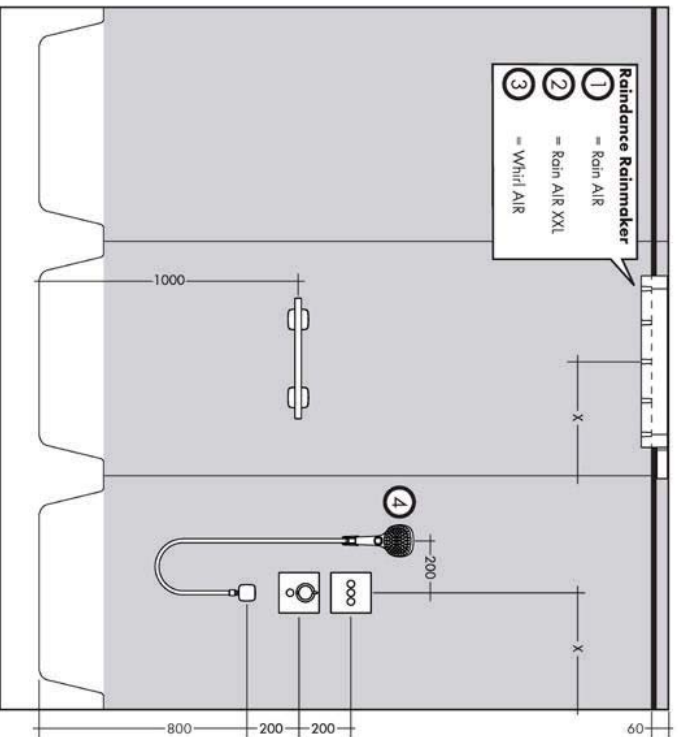
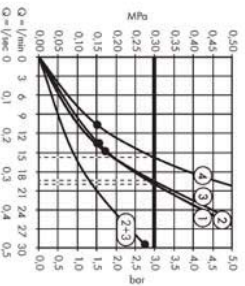

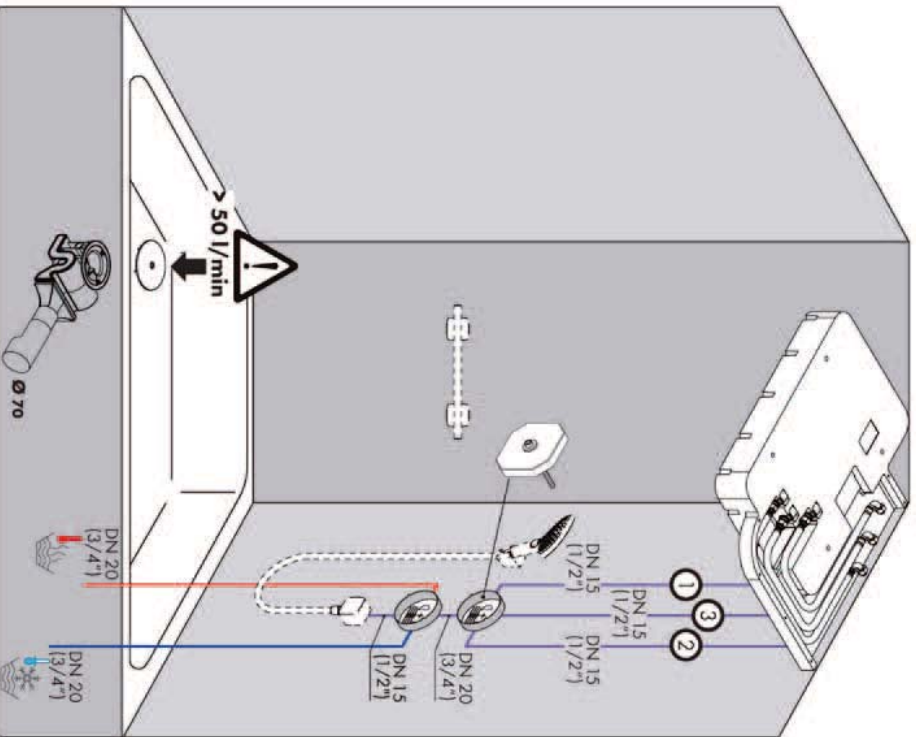

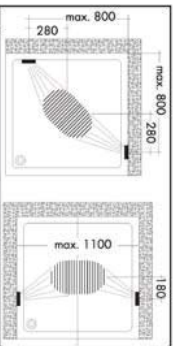
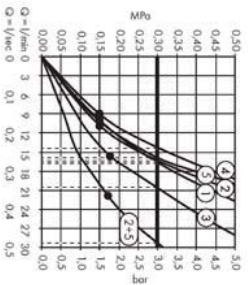
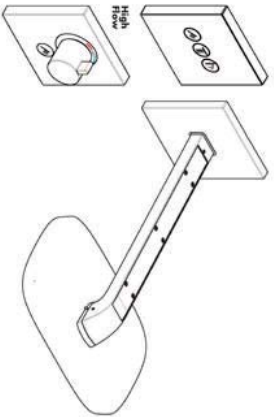

- Raindance Select 300**
- ① = Rain
 - ② = RainAir
 - ③ = RainStream

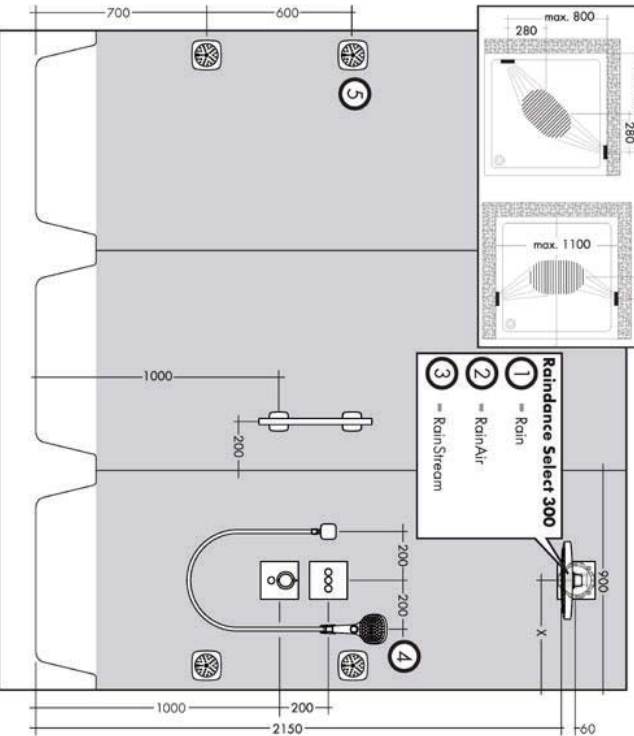

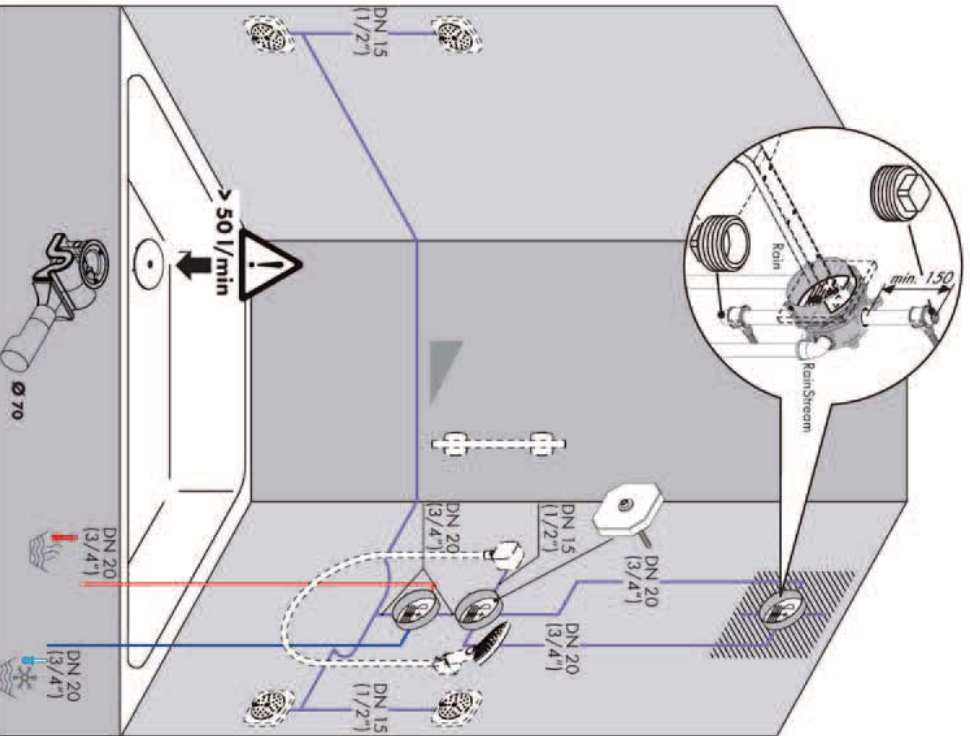

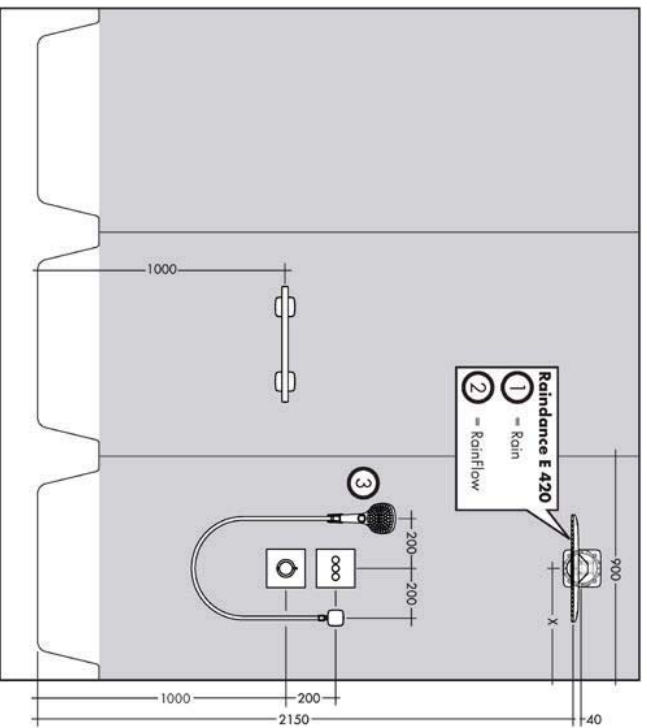
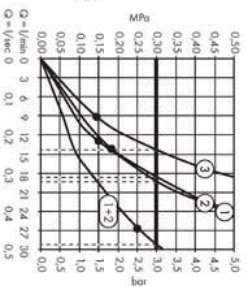
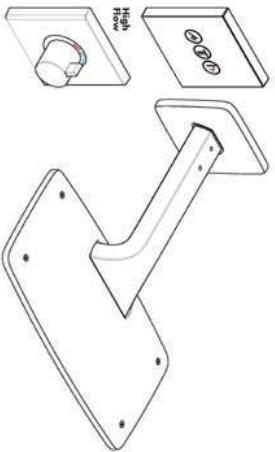

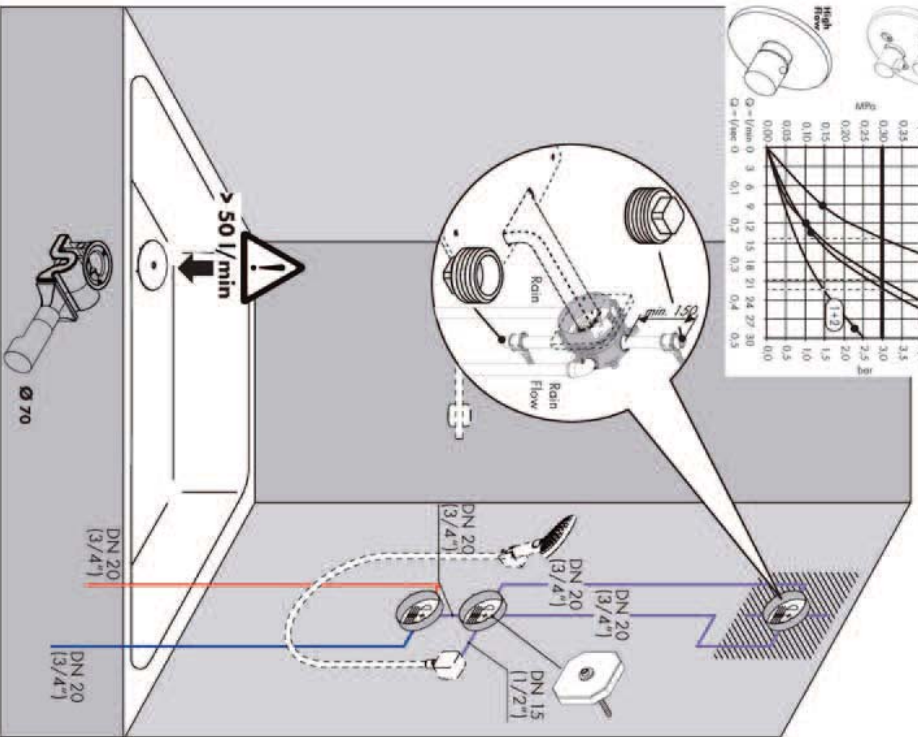
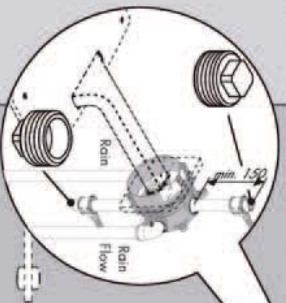
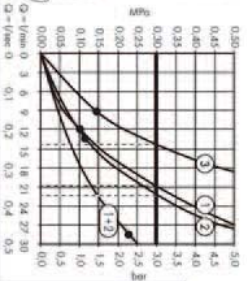

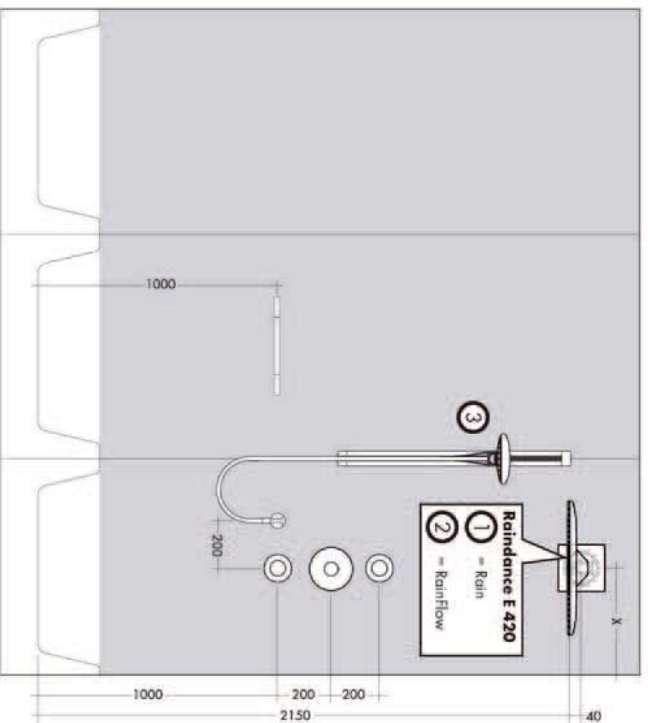
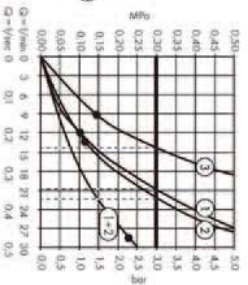
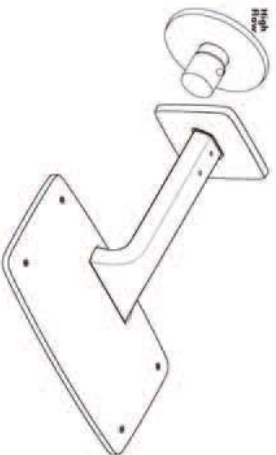

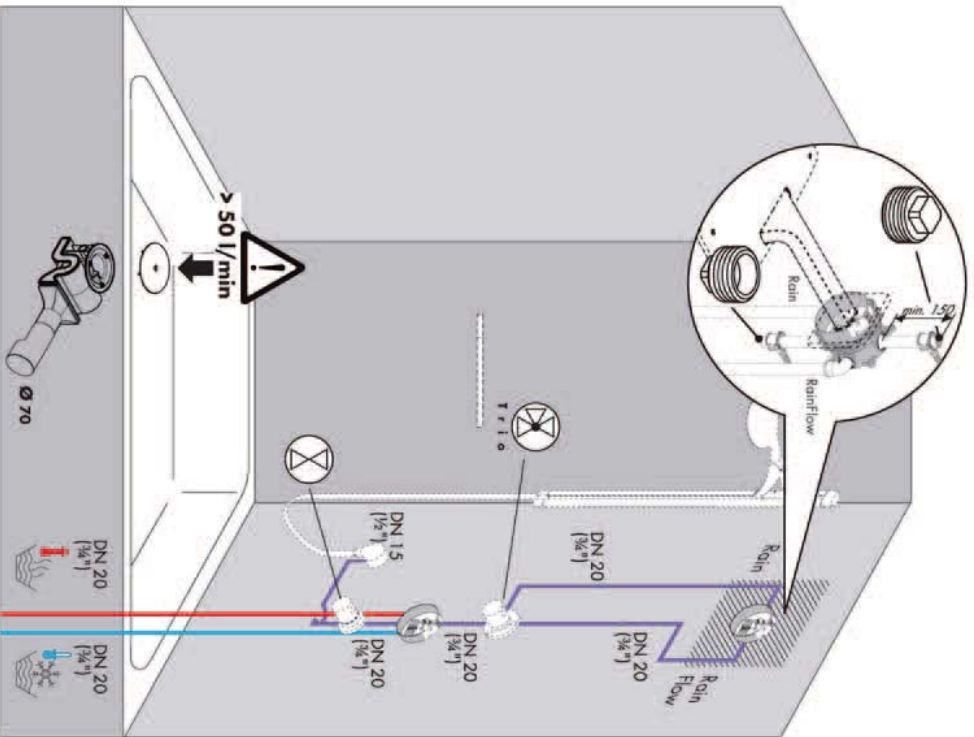

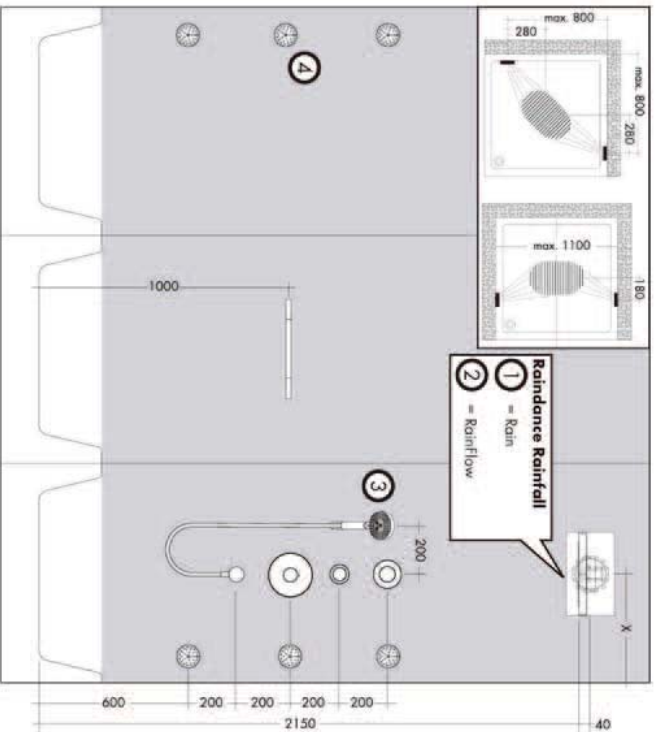
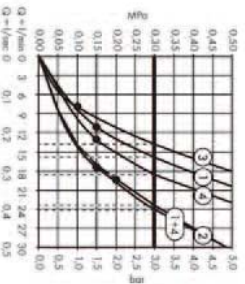

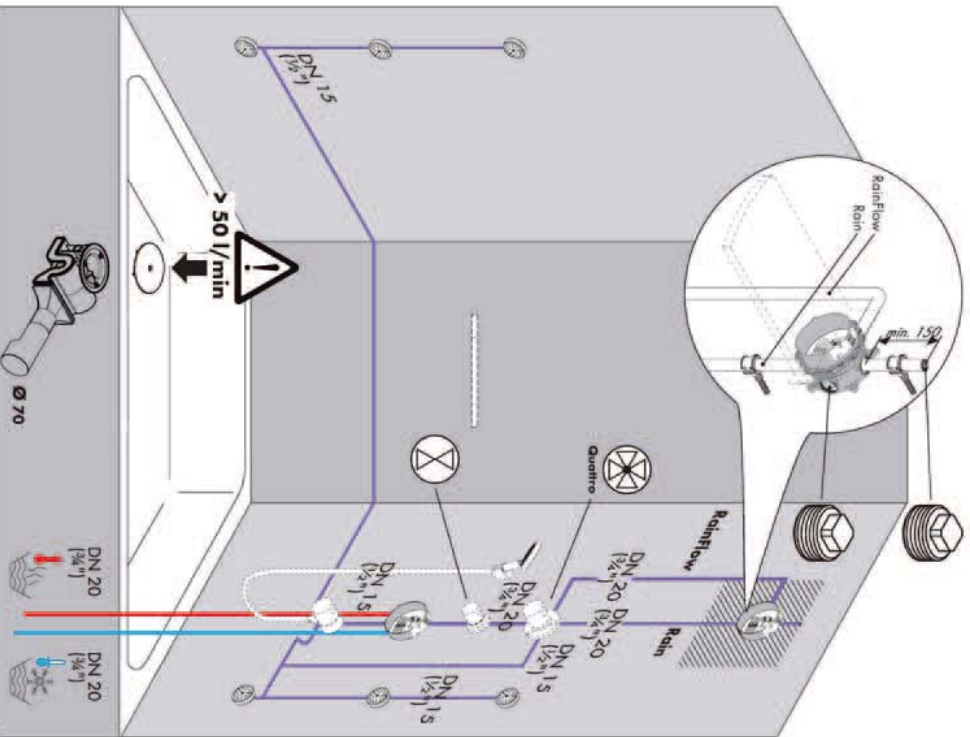



High
Flow

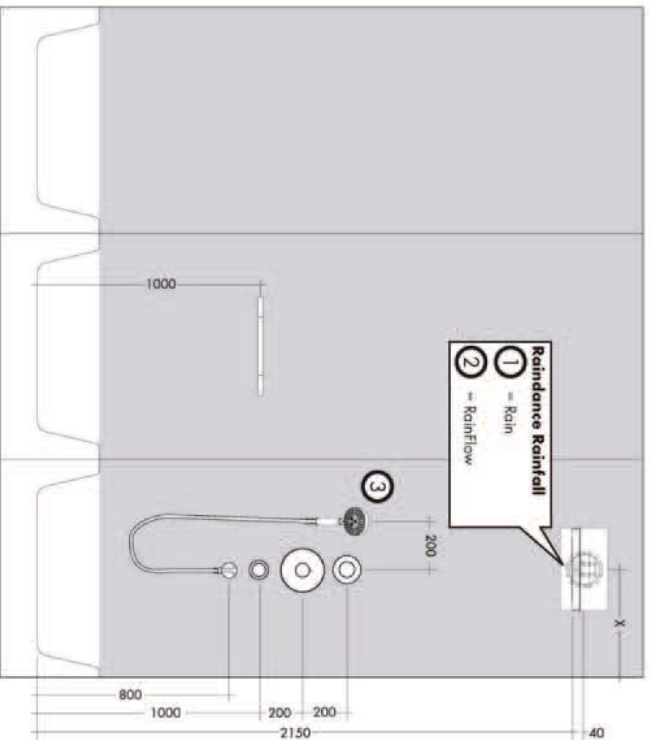
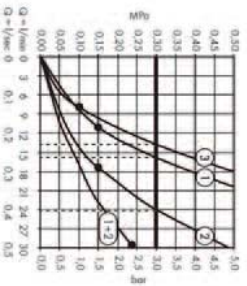

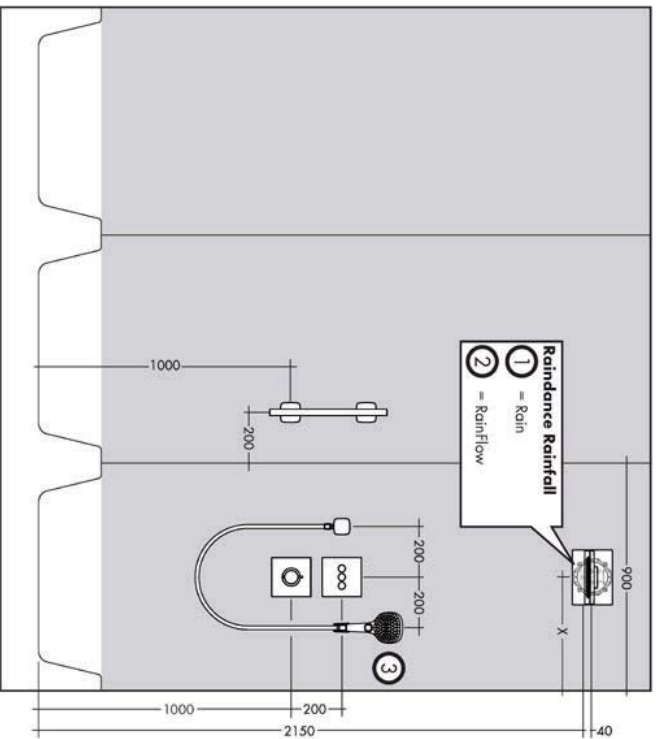
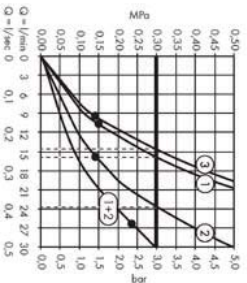

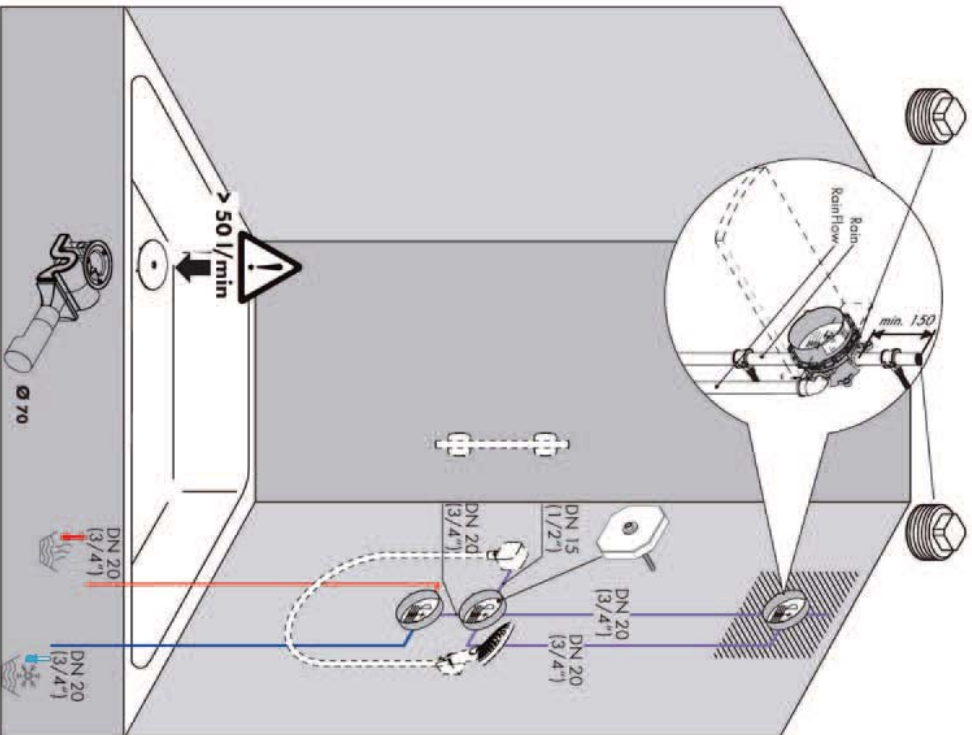

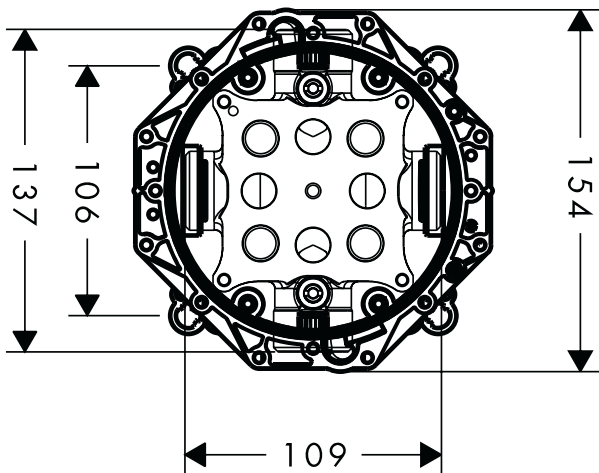
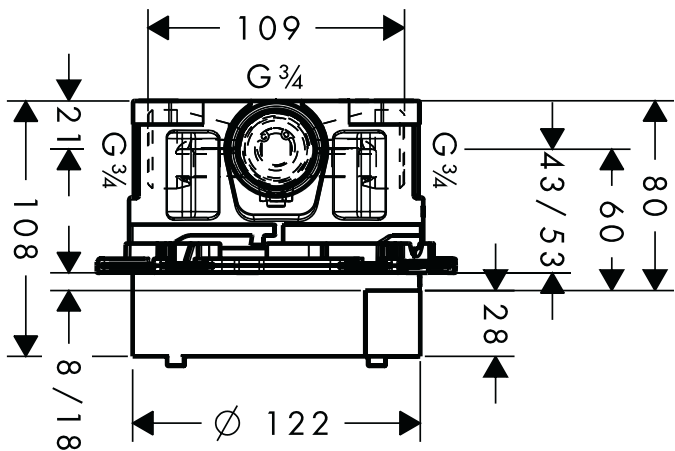

hansgrohe

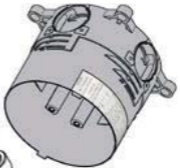

97759000



97739000



98797000

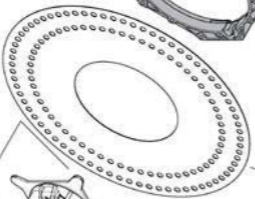

96445000

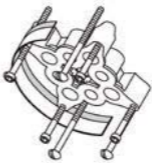

13595000

98119000

(9x2)

SW 5 mm



97611000



98560000

AXXOR®

hansgrohe

DE	Montageanleitung	2
FR	Instructions de montage	2
EN	assembly instructions	3
IT	Istruzioni per l'installazione	3
ES	Instrucciones de montaje	4
NL	Handleiding	4
DK	Monteringsvejledning	5
PT	Manual de Instalação	5
PL	Instrukcja montażu	6
CS	Montážní návod	6
SK	Montážny návod	7
ZH	组裝说明	7
RU	Инструкция по монтажу	8
HU	Szerelési útmutató	8
FI	Asemusohje	9
SV	Monteringsanvisning	9
LT	Montavimo instrukcijos	10
HR	Uputstva za instalaciju	10
TR	Montaj kılavuzu	11
RO	Instrucțiuni de montare	11
EL	Οδηγία συναρμολόγησης	12
SL	Navodila za montažo	12
ET	Paialdusjuhend	13
LV	Montāžas instrukcija	13
SR	Uputstvo za montažu	14
NO	Montasjerveiledning	14
BG	Ръководство за монтаж	15
SQ	Udhëzime tërëth montimit	15
AR	تعليمات التجميع	16

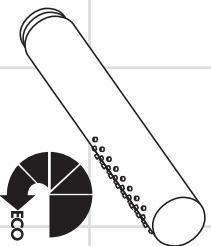

Starck
1 053 1000

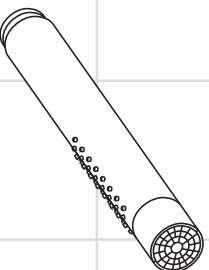

Starck
2 853 2000



Sicherheitshinweise

- ⚠ Der Kontakt der Brausestrahlen mit empfindlichen Körperstellen (z. B. Augen) muss vermieden werden. Es muss ein ausreichender Abstand zwischen Brause und Körper eingehalten werden.

Montage (siehe Seite 19)

- Die der Brause beige packte Siebdichtung muss eingebaut werden, um Schmutzeinspülungen aus dem Leitungsnetz zu vermeiden. Schmutzeinspülungen können die Funktion beeinträchtigen und/oder zu Beschädigungen an Funktionsteilen der Brause führen, für hieraus ergebende Schäden haftet Hansgrohe nicht.

- Reinigung** (siehe Seite 20) und beiliegende Broschüre

Technische Daten

- Betriebsdruck: max. 0,6 MPa
- Empfohlener Betriebsdruck: 0,1 - 0,4 MPa (1 MPa = 10 bar = 147 PSI)
- Heißwassertemperatur: max. 60°C
- Thermische Desinfektion: max. 70°C / 4 min

Prüfzeichen (siehe Seite 17)

Serviceteile (siehe Seite 19)



Consignes de sécurité

- ⚠ Éviter le contact du jet de la douche avec les parties sensibles du corps (telles par ex. que les yeux). Veiller à respecter un écart suffisant entre la douche et le corps

Montage (voir page 19)

- Le joint à filtre fourni avec la pomme de douche à main doit être installé afin de retenir des impuretés du système de conduites. Ceux-ci pourraient influencer le fonctionnement de ce produit et même endommager des pièces mobiles. Des réclamations à la suite de l'usage de la pomme de douche sans joint-tamis de hansgrohe ne peuvent pas faire partie de notre garantie.

- Nettoyage** (voir page 20) et brochure ci-jointe

Informations techniques

- Pression de service autorisée: max. 0,6 MPa
- Pression de service conseillée: 0,1 - 0,4 MPa (1 MPa = 10 bar = 147 PSI)
- Température d'eau chaude: max. 60°C

Désinfection thermique:

max. 70°C / 4 min

Classification acoustique et

débit (voir page 17)

Pièces détachées (voir pages 19)

**Safety Notes**

- ⚠ Do not allow the streams of the shower touch sensitive body parts (such as your eyes). An adequate distance must be kept between the shower and you.

**Indicazioni sulla sicurezza**

- ⚠ Bisogna evitare il contatto fra il getto della doccia e parti del corpo delicate (ad es. gli occhi). Fra il soffione ed il corpo va mantenuta una distanza sufficiente.

Assembly (see page 19)

The mesh washer must be insert to protect the overhead shower against incoming dirt by pipework. Incoming dirt leads to defects or/and can damage parts of the shower; such caused faults voids all liability and guarantee claims.

Cleaning (see page 20) and enclosed brochure

Technical Data

Operating pressure: max. 0,6 MPa
Recommended operating pressure: 0,1 - 0,4 MPa
(1 MPa = 10 bar = 147 PSI)
Hot water temperature: max. 60 °C
Thermal disinfection: max. 70 °C / 4 min

Test certificate (see page 17)

Spare parts (see page 19)

Montaggio (vedi pagg. 19)

Per proteggere la soffione doccia da eventuali impurità provenienti dalle tubazioni dell'acqua, deve essere inserito il filtro nell'impugnatura della doccia stessa. Tali impurità possono infatti causare difetti e/o danneggiare parti della doccia; in questo caso la Hansgrohe non risponde dei danni.

Pulitura (vedi pagg. 20) e brochure allegata

Dati tecnici

Pressione d'uso: max. 0,6 MPa
Pressione d'uso consigliata: 0,1 - 0,4 MPa
(1 MPa = 10 bar = 147 PSI)
Temperatura dell'acqua calda: max. 60 °C
Disinfezione termica: max. 70 °C / 4 min

Segno di verifica (vedi pagg. 17)

Parti di ricambio (vedi pagg. 19)

**Indicaciones de seguridad**

- ⚠ Debe evitarse el contacto del chorro del pulverizador con partes sensibles del cuerpo (por ej. ojos). Debe mantenerse una distancia suficiente entre pulverizador y cuerpo.

**Veiligheidsinstructies**

- ⚠ Het contact van de douchestraal met gevoelige lichaamsdelen (bijv. ogen) moet worden voorkomen. Er moet voldoende afstand tussen douche en lichaam aangehouden worden.

Montaje (ver página 19)

La junta de filtración que se suministra con la ducha mural evita que las partículas de suciedad procedentes de las tuberías lleguen a la ducha mural. Debe colocarse entre el flexo y la ducha mural. Infiltraciones de suciedad deterioran el funcionamiento de la ducha mural y pueden causar daños en el interior de la misma que no están cubiertas por la garantía de Hansgrohe.

Montage (zie blz. 19)

Het bij de hoofddouche verpakte zeefje moet worden ingebouwd om vuil uit de waterleiding te weren. Vuil uit de leidingen kan de werking van de hoofddouche negatief beïnvloeden en/of de hoofddouche beschadigen. Voor deze schade is Hansgrohe niet verantwoordelijk.

Limpia (ver página 20) y folleto anexo

Reinigen (zie blz. 20) en bijgevoegde brochure

Datos técnicos

Presión en servicio: max. 0,6 MPa
Presión recomendada en servicio: 0,1 - 0,4 MPa
(1 MPa = 10 bar = 147 PSI)
Temperatura del agua caliente: max. 60 °C

Desinfección térmica:
max. 70 °C / 4 min

Marca de verificación (ver página 17)

Technische gegevens
Werkdruk: max. 0,6 MPa
Aanbevolen werkdruk: 0,1 - 0,4 MPa
(1 MPa = 10 bar = 147 PSI)
Temperatuur warm water: max. 60 °C
Thermische desinfectie:
max. 70 °C / 4 min

Keurmerk (zie blz. 17)

Service onderdelen (zie blz. 19)

Repuestos (ver página 19)



Sikkerhedsanvisninger

- Bruserstrålets kontakt med sensitive områder (f.eks. øjne) skal undgås. Der skal være en tilstrækkelig afstand mellem bruseren og kroppen.

Montering (se s. 19)

Den vedlagte smudsfangssi skal indsættes i bruseren for at undgå snøvs fra rørsystemet. Indskyllet snøvs kan have indflydelse på bruserens funktion og/eller føre til beskadigelser på håndbruserens funktionsdele.

Rengøring (se s. 20) og vedlagt brochure

Tekniske data

- Driftstryk: max. 0,6 MPa
 - Anbefalet driftstryk: 0,1 - 0,4 MPa (1 MPa = 10 bar = 147 PSI)
 - Varmtvandstemperatur: max. 60°C
 - Termisk desinfektion: max. 70°C / 4 min
- Godkendelse** (se s. 17)
- Reserve dele** (se s. 19)



Avisos de segurança

- Deve-se evitar o contacto dos jactos de água com partes do corpo sensíveis (p. ex. olhos). É necessário manter uma distância suficiente entre o chuveiro e o corpo.

Montagem (ver página 19)

O filtro de rede deve ser colocado para proteger o chuveiro de areias e resíduos provenientes da tubagem. Resíduos e areias podem danificar componentes, ou provocar mau funcionamento do chuveiro; as avarias assim provocadas anulam a nossa responsabilidade e anulam a nossa garantia.

Limpeza (ver página 20) e brochura em anexo

Dados Técnicos

- Pressão de funcionamento: max. 0,6 MPa
- Pressão de func. recomendada: 0,1 - 0,4 MPa (1 MPa = 10 bar = 147 PSI)
- Temperatura da água quente: max. 60°C
- Desinfecção térmica: max. 70°C / 4 min

Marca de controlo (ver página 17)

Peças de substituição (ver página 19)

**Wskazówki
bezpieczeństwa**

- ⚠ Należy unikać kontaktu strumienia wypływającego z głowicy z wrażliwymi częściami ciała (np. oczami). Należy zachowywać odpowiednią odległość pomiędzy głowicą a ciałem.

Montaż (patrz strona 19)

Znajdujące się przy przysznicy siłko musi zostać zainstalowane, aby zatrzymać zanieczyszczenia z instalacji. Przedostające się zanieczyszczenia mogą mieć ujemny wpływ na działanie i/lub prowadzić do usterek w działaniu elementów przysznica. Za powstałe z tego tytułu szkody firma Hansgrohe nie ponosi odpowiedzialności.

Czyszczenie (patrz strona 20) i dotychczas broszura

Dane techniczne

Cisnienie robocze: maks. 0,6 MPa
Zalecane ciśnienie robocze: 0,1 - 0,4 MPa
(1 MPa = 10 bary = 147 PSI)
Temperatura wody
gorącej: maks. 60 °C
Dezynfekcja
termiczna: maks. 70 °C / 4 min

Znak jakości (patrz strona 17)

Części serwisowe (patrz strona 19)

**Bezpečnostní pokyny**

- ⚠ Je nutné zabránit kontaktu vodních paprsků sprchy s měkkými částmi těla (např. očima). Je nutné dodržovat dostatečný odstup mezi sprchou a tělem.

Montáž (viz strana 19)

Do přívodu musí být zabudováno se sprchou dodávané sítko, aby zachycovalo nečistoty vyplavené z vodovodní sítě. Vyplavené nečistoty mohou ovlivnit funkci sprchy a nebo mohou vést i k jejímu poškození. Na takto vzniklé škody se nevztahuje záruka firmy Hansgrohe.

Čištění (viz strana 20) a příložená brožura

Technické údaje

Provozní tlak: max. 0,6 MPa
Doporučený provozní tlak: 0,1 - 0,4 MPa
(1 MPa = 10 bar = 147 PSI)
Teplota horké vody: max. 60 °C
Tepelná desinfekce: max. 70 °C / 4 min
Zkušební značka (viz strana 17)
Servisní díly (viz strana 19)

**Bezpečnostné pokyny**

- △ Vyhýbajte sa kontaktu vodného lúča sprchy s citlivými miestami tela (napr. očí). Dodržiavajte dostatočnú vzdialenosť medzi sprchou a telom.

Montáž (viď strana 19)

Do prívodu musí byť zabudované so sprchou dodávané sítko, aby zachytilo nečistoty vyplavené z vodovodnej siete. Vypravené nečistoty môžu ovlivniť funkciu sprchy, alebo spôsobiť jej poškodenie. Na takto vzniknuté škody sa nevzťahuje záruka firmy Hansgrohe.

Čistenie (viď strana 20) a priložená brožúra

Technické údaje

Prevádzkový tlak: max. 0,6 MPa
 Doporučený prevádzkový tlak: 0,1 - 0,4 MPa
 (1 MPa = 10 bar = 147 PSI)
 Teplota teplej vody: max. 60 °C
 Termická dezinfekcia:
 max. 70 °C / 4 min

Osvedčenie o skúške

(viď strana 17)

Servisné diely (viď strana 19)

**安全技巧**

- △ 必須避免让身体敏感部位（如眼睛）接触到莲蓬头喷水。必须保持莲蓬头与人头之间有足够的距离。

安装 (参见第 19 页)

必须装上花洒所附带的滤网密封垫，以过滤管道里的杂质污物。杂质污物会影响花洒的功能和/或损坏花洒的功能部件，由此而产生的产品损坏不属于汉斯格雅的保护范围。

清洗 (参见第 20 页) 并附有手册

技术参数
工作压力: 最大 0,6 MPa
推荐工作压力: 0,1 - 0,4 MPa
 (1 MPa = 10 bar = 147 PSI)
热水温度: 最大 60 °C
热力消毒: 最大 70 °C / 4 分钟
检验标记 (参见第 17 页)
备用零件 (参见第 19 页)

**Указания по технике безопасности**

- ⚠ Не допускайте попадания струи воды из разбрызгивателя на чувствительные части тела (например, на глаза).
- Разбрызгиватель следует устанавливать на достаточном расстоянии от тела.

Монтаж (см. стр. 19)

Для предотвращения попадания частиц грязи из водопроводной сети необходимо установить фильтр, прилагаемый к ручному душу.

Частицы грязи могут нарушить отдельные функции и/или привести к повреждению функциональных деталей ручного душа, Hansgrohe не несет ответственность за повреждение вследствие отсутствия фильтра.

Очистка (см. стр. 20) и прилагаемая брошюра

Технические данные

Рабочее давление: не более. 0,6 МПа
Рекомендуемое рабочее давление: 0,1 - 0,4 МПа
(1 МПа = 10 bar = 147 PSI)
Температура горячей воды: не более. 60 °C

Термическая дезинфекция:

не более. 70 °C / 4 мин

Знак технического контроля
(см. стр. 17)

Комплект (см. стр. 19)

8

**Biztonsági utasítások**

- ⚠ Kerülni kell a zuhanyugár érintkezését érzékeny testrészekkel (pl. szemek). Be kell tartani a megfelelő távolságot a zuhanyfej és a test között.

Szerelés (lásd a 19. oldalon)

A kézi zuhanyhoz csomagolt szűrőtípfest be kell szerelni a vízhálózatról származó szempeződések kiküszöbölésére.

A beáramló szempeződések akadályozhatják és / vagy teljesen tönkre is tehetnek a zuhany funkcióit. Az ezekből adódó károkat a Hansgrohe nem felel.

Tisztítás (lásd a 20. oldalon) és mellékelt broszúrával

Műszaki adatok

Üzemi nyomás: max. 0,6 МПа
Ajánlott üzemi nyomás: 0,1 - 0,4 МПа
(1 МПа = 10 bar = 147 PSI)
Forgóvíz hőmérséklet: max. 60 °C
Termikus fertőtlenítés:

max. 70 °C / 4 perc

Vizsgajel (lásd a 17. oldalon)

Tartozékok (lásd a 19. oldalon)

**Turvallisuusohjeet**

- △ Suihkuveden kontaktia herkkien ruumiinosien (esim. silmien) kanssa on vältettävä. Suihkun ja vartalon välissä on oltava riittävä väli.

Asennus (katso sivu 19)

Käsisuihkun mukana toimitettu sihtitiiviste on asennettava paikalleen, jotta lian huuhoutuminen vesijohtoverkostosta käsisuihkuun estyy. Huuhoutuvat likahukkaset voivat häiritä suihkun toimintaa tai vahingoittaa toimintaosia, Hansgrohe ei vastaa tästä aiheutuneista vahingoista.

Puhdistus (katso sivu 20) ja

ohainen esite

Tekniset tiedot

Käyttöpaino: maks. 0,6 MPa
Suositeltu käyttöpaino: 0,1 - 0,4 MPa
(1 MPa = 10 bar = 147 PSI)
Kuuman veden lämpötila: maks. 60 °C
Lämpödesinfektio: maks. 70 °C / 4 min

Koestusmerkki (katso sivu 17)**Varaosat** (katso sivu 19)**Säkerhetsanvisningar**

- △ Undvik att rika duschstrålarna mot känsliga kroppsdelar (t. ex. ögonen). Det måste finnas ett tillräckligt stort avstånd mellan duschen och kroppen.

Montering (se sidan 19)

Silpackningen som följer med duschen måste monteras för att undvika att smuts från ledningsröret tränger in. Smuts som spolas in kan påverka funktionerna och/eller leda till skador på funktionsdelar i duschen. Hansgrohe fransäger sig allt ansvar för skador som kan härledas till detta.

Rengöring (se sidan 20) och medföljande broschyr

Tekniska data

Driftstryck: max. 0,6 MPa
Rek. driftstryck: 0,1 - 0,4 MPa
(1 MPa = 10 bar = 147 PSI)
Yrmyvattentemperatur: max. 60 °C
Termisk desinfektion: max. 70 °C / 4 min

Testsigill (se sidan 17)**Reservdelar** (se sidan 19)

**Saugumo technikos nurodymai**

- ⚠ Būitina vengti dušo vandens srovės kontakto su jautriomis kūno vietomis (pvz., akimis). Todėl būitina laikytis tinkamu atstumu nuo dušo.

Montavimas (žr. psl. 19)

Tinkelis, kuris yra rankų dušas pakuojęje, privalo būti įstaiytas, kad būtų apsaugota nuo išorės nešvarumų. Nešvarumai gali pakenkti rankų dušas funkcionalumui ir (arba) sugadinti rankų dušas funkcines dalis. Tokiu atveju „Hansgrohe“ atsakomybės neprišima.

Valymas (žr. psl. 20) ir pridėjama brošiūra

Techniniai duomenys

Darbinis slėgis:

ne daugiau kaip 0,6 MPa
Rekomenduojamas slėgis: 0,1 - 0,4 MPa
(1 MPa = 10 barų = 147 PSI)

Karšio vandens

temperatūra: ne daugiau kaip 60°C
Terminis dezinfekavimas:

ne daugiau kaip 70°C / 4 min

Bandymo pažyma (žr. psl. 17)

Atsarginės dalys (žr. psl. 19)

**Sigurnosne upute**

- ⚠ Mora se izbjegavati kontakt mlaza iz tuša s osjetljivim dijelovima tijela (npr. očima). Tijelo korisnika mora biti dovoljno udaljeno od tuša.

Sastavijanje (pogledaj stranicu 19)

Filter potrebno je ugraditi kako bi se regulirao protok vode i smanjio dotok prljavštine. Za eventualna oštećenja uzrokovana prljavštinom proizvođač Hansgrohe nije odgovoran.

Čišćenje (pogledaj stranicu 20) i priložena brošiura

Tehnički podatci

Najveći dopušteni tlak: tlak 0,6 MPa
Preporučeni tlak: 0,1 - 0,4 MPa
(1 MPa = 10 bar = 147 PSI)

Temperatura vruće vode: tlak 60°C

Termička dezinfekcija:

tlak 70°C / 4 min

Oznaka testiranja

(pogledaj stranicu 17)

Rezerwni dijelovi

(pogledaj stranicu 19)

**Güvenlik uyarıları**

- ⚠ Püskürtme başlıklarının hassas organlara teması (örn. gözler) önlenmelidir. Püskürtücü ile beden arasında yeterli mesafe bırakılmalıdır.

Montajı (Bakınız sayfa 19)

El duşu kafasına eklenmiş olan süzgeç contası, boru şebekesinden sızan kirlerin önüne geçmek için, yerine monte edilmelidir. İçeri sızan bu kirler duşun fonksiyonunu sekteleyebilir ve/veya duşun fonksiyon parçaları üzerinde hasarlara sebep olabilir, bu yüzden meydana gelen hasarlardan Hansgrohe sorumlu tutulamaz.

Temizleme (Bakınız sayfa 20) ve

birlikte verilen broşür

Teknik bilgiler

İşletme basıncı: azami 0,6 MPa
Tavsiyè edilen işletme basıncı: 0,1 - 0,4 MPa
(1 MPa = 10 bar = 147 PSI)
Sıcak su sıcaklığı: azami 60 °C
Termik dezenteksiyon: azami 70 °C / 4 dak

Kontrol işaretleri (Bakınız sayfa 17)

Yedek Parçalar (Bakınız sayfa 19)

**Instrucțiuni de siguranță**

- ⚠ Evitați contactul jetului de apă cu părțile de corp sensibile (de ex. ochi). Țineți dușul la o distanță corespunzătoare de corp.

Montare (vezi pag. 19)

Montajii garnitura de filtru livrată împreună cu capătul de duș de mână pentru evitarea pătrunderii impurităților din rețeaua de alimentare. Impuritățile pătrunse pot influența funcționarea aparatului și/sau provoca deteriorarea capătului de duș. Garanția nu acoperă aceste daune.

Curățare (vezi pag. 20) și broșura

alăturată

Date tehnice

Presiune de functionare: max. 0,6 MPa
Presiune de funcționare recomandată: 0,1 - 0,4 MPa
(1 MPa = 10 bar = 147 PSI)
Temperatura apei calde: max. 60 °C
Dezinfecție termică: max. 70 °C / 4 min

Certificat de testare (vezi pag. 17)

Piese de schimb (vezi pag. 19)

**Υποδείξεις ασφαλείας**

- ⚠ Η επαφή δέσμης νερού του ντους με ευαίσθητες περιοχές του σώματος (π.χ. μάτια) πρέπει να αποφευχθεί. Διατηρείτε επαρκή απόσταση ανάμεσα στο ντους και το σώμα.

**Varnostna opozorila**

- ⚠ Izogibati se je treba stiku prhalnega curka z občutljivimi deli telesa (npr. očmi). Med telesom in prho mora biti vedno zadosten razmik.

Συναρμολόγηση (βλ. σελίδα 19)

Πρέπει να εγκατασταθεί το παρίμβυσια φίλτρου που συνοδεύει τον καταιονιστήρα κατά τέτοιο τρόπο, ώστε να αποφεύγονται ρυτίες που προέρχονται από το δίκτυο ύδρευσης. Οι ρυτίες από το δίκτυο ύδρευσης, μπορούν να επηρεάσουν αρνητικά και/ή να προξενήσουν ζημία στα λειπουρικά τμήματα του καταιονιστήρα (ντους). Τέτοιου είδους ζημιές δεν καλύπτονται από την εγγύηση Hansgrohe.

Καθαρισμός (βλ. σελίδα 20) και συντηγμένο φυλλάδιο

Τεχνικά Χαρακτηριστικά

Λειτουργία πίεσης: έως 0,6 MPa
Συνιστώμενη λειτουργία πίεσης: 0,1 - 0,4 MPa
(1 MPa = 10 bar = 147 PSI)

Θερμοκρασία ζεστού νερού: έως 60 °C

Θερμική απολύμανση: έως 70 °C / 4 min

Σήμα ελέγχου (βλ. σελίδα 17)

Ανταλλακτικά (βλ. σελίδα 19)

Montage (glejite stran 19)

Filter, ki je priložen ročni prhi, je potrebno vgraditi, da prho zaščitiimo pred umazanijo iz vodovodne napeljavne. Umazanija lahko okvari ali poškoduje dele ročne prhe. Za tako nastalo škodo Hansgrohe ne odgovarja.

Čiščenje (glejte stran 20) in priložena brošura

Tehnični podatki

Delovni tlak: maks. 0,6 MPa
Priporočeni delovni tlak: 0,1 - 0,4 MPa
(1 MPa = 10 bar = 147 PSI)
Temperatura tople vode: maks. 60 °C
Termična dezinfekcija:

maks. 70 °C / 4 min

Preskusni znak (glejte stran 17)

Rezervni deli (glejte stran 19)

**Ohutusjuhised**

- ⚠️ Duši veeloaad ei tohi kokku puutuda tundlike kehaosadega (nt silmad).
Jätke duši ja keha vahele piisav vahe.

**Drošības norādes**

- ⚠️ Nepieciešams izvairīties no dušas strūkļas tieša kontakta ar jutīgām ķermeņa daļām (piem., acīm).
Nepieciešams ievērot pietiekošu attālumu starp dušu un ķermeni.

Paigaldamine (vt lk 19)

Kaismaks duši torust tuleva mustuse eest, on vaja paigaldada dušiga kaasašolev mustusesöl. Sissetulev mustus vöib funkcioneerimist kahjustada ja/vöi rikkuda duši detaile. Sellest tulenevate kahjude eest Hansgrohe ei vastuta.

Puhastamine (vt lk 20) ja

kaasašolev brošüür

Tehnilised andmed

Töörökh maks. 0,6 MPa
Soovitatav töörökh: 0,1 - 0,4 MPa
(1 MPa = 10 baari = 147 PSI)
Kuuma vee temperatuur: maks. 60°C
Termiline desinfektsioon:
maks. 70°C / 4 min

Kontrollsertifikaat (vt lk 17)**Varuosad** (vt lk 19)**Montāža** (skat. 19. lpp.)

Jāiemontē dušas komplektā esošais filtrs, lai novērstu neīrīrumu ieplūšanu no ūdens vada. Ieskalotie neīrīrumi var traucēt dušas funkciju un / vai arī izraisīt rokas dušas daļu bojājumus, par kuriem Hansgrohe nenes atbildību.

Trīšana (skat. 20. lpp.) un klāt pievienotais buklets

Tehniskie dati

Darba spiediens: maks. 0,6 MPa
Ieteicamais darba spiediens: 0,1 - 0,4 MPa
(1 MPa = 10 bar = 147 PSI)
Karstā ūdens temperatūra: maks. 60°C
Termiskā dezinfekcija :
maks. 70°C / 4 min

Pārbaudes zīme (skat. 17. lpp.)

Rezerves daļas (skat. 19. lpp.)

**Sigurnosne napomene**

- ⚠ Mora se izbegavati kontakt mlaza iz tuša sa osećljivim delovima tela (npr. očima). Telo korisnika mora biti na dovoljnom odstojanju od tuša.

Montaža (vidi stranu 19)

- Obavezno ugradite mrežicu upakovanu s tušem, čime sprečavate ulazak prljavaštine iz vodovoda. Prljavaština može dovesti do delimičnog ili potpunog oštećenja delova tuša. Za eventualna oštećenja uzrokovana prljavaštinom proizvođač Hansgrohe nije odgovoran.

Čišćenje (vidi stranu 20) i priložena brošura**Tehnički podaci**

- Radni pritisak: maks. 0,6 MPa
Preporučeni radni pritisak: 0,1 - 0,4 MPa
(1 MPa = 10 bar = 147 PSI)
Temperatura vruće vode: maks. 60°C
Termička dezinfekcija: maks. 70°C / 4 min
- Ispitni znak** (vidi stranu 17)
- Rezervni delovi** (vidi stranu 19)

**Sikkerhetshenvisninger**

- ⚠ Dusjstrålen skal ikke komme i kontakt med ømfintlige kroppsdeler (f.eks. øynene). Overhold en tilstrekkelig avstand mellom dusjen og kroppen.

Montasje (se side 19)

- Slipakningen som er levert med dusjen skal bygges inn for å forhindre at smuss spyles inn fra ledningsnettet. Innspylt smuss kan påvirke funksjonen negativt og/eller kan medføre skader på hånddusjens funksjonsdeler. Hansgrohe påtar seg inget ansvar for skader som resulteres av dette.

Rengjøring (se side 20) og vedlagt brosjyre**Tekniske data**

- Driftstrykk maks. 0,6 MPa
Anbefalt driftstrykk: 0,1 - 0,4 MPa
(1 MPa = 10 bar = 147 PSI)
Yarmt vannstemperatur maks. 60°C
Termisk desinfisering: maks. 70°C / 4 min
- Prøvermerke** (se side 17)
- Servicedeler** (se side 19)



Указания за безопасност

- ⚠️ Трябва да се избягва контакта на струите на разпръсквателя с чувствителни части на тялото (напр. очите). Между разпръсквателя и тялото трябва да се спазва достатъчно разстояние.

Монтаж (вижте стр. 19)

Опакването заедно с разпръсквателя улътнение с цедка трябва да се монтира, за да се избегне натрупване на замърсявания от водопроводната мрежа. Натрупването на замърсявания може да наруши функцията и/или да доведе до увреждания на функционалните части на разпръсквателя, Hansgrohe не носи отговорност за получилите се по този начин щети.

Почистяване (вижте стр. 20) и приложена брошура

Технически данни

Работно налягане: макс. 0,6 МПа
Препоръчително работно

налягане: 0,1 - 0,4 МПа
(1 МПа = 10 bar = 147 PSI)

Температура на горещата вода: макс. 60°C
Термична дезинфекция: макс. 70°C / 4 мин

Контролен знак (вижте стр. 17)

Сервизни части (вижте стр. 19)



Udhëzime sigurie

- ⚠️ Kontakti i valëve të dushit me pjesët e ndeshme të trupit (p.sh. me sytë) duhet që të shmangët. Midis dushit dhe trupit duhet që të mbahet një distancë e miftueshme.

Montimi (shih faqen 19)

Sita që i kemi bashkëngjitur spërkatëses duhet përdorur për të evituar fthitjen e paparsëritive nga rrieti i ujësiellësit. Ndojëet mund të dëmtojnë pjesë funksionale të spërkatëses. Hansgrohe nuk merr përgjegjësinë për dëmet e shkaktuara në këtë mënyrë.

Pastrimi (shih faqen 20) dhe broshura bashkëngjiftur

Të dhëna teknike

Presioni gjatë punës maks. 0,6 МПа
Presioni i rekomanduar: 0,1 - 0,4 МПа
(1 МПа = 10 bar = 147 PSI)

Температура е ujit të ngrohtë maks. 60°C
Dezinfektim Termik: maks. 70°C / 4 min

Shenja e kontrollit (shih faqen 17)

Pjesë ndërrimi (shih faqen 19)

⚠️ تنبيهات الأمان

⚠️ يجب تجنب حدوث اتصال مباشر بين الماء الخارج من رأس الدش وبين أجزاء الجسم الحساسة (مثل العينين). يجب وجود مسافة كافية بين رأس الدش والجسم.

التركيب (راجع صفحة 19)
يجب إدخال الحلقة الشبكية لحماية الدش اليدوي من الأوساخ التي تحملها شبكة الواسير. حيث تؤدي الأوساخ الواردة إلى حدوث أعطال أو / وقد تتسبب في تلف أجزاء من من الدش. ومثل هذه الأعطال تلغي كافة المطالبات الخاصة بالسؤولية أو الضمان.
التنظيف (راجع صفحة 20) والكتيب الرفق

المواصفات الفنية

ضغط التشغيل:

الحد الأقصى 0,6 ميجابسكال

ضغط التشغيل الموصى به:

0,4-0,1 ميجابسكال

1 ميجابسكال = 10 بار = 147 (PSI)

درجة حرارة الماء الساخن:

الحد الأقصى 60°C

تقييم حراري:

الحد الأقصى 70°C / 4 الدقيقة

شهادة اختبار (راجع صفحة 17)

قطع الغيار (راجع صفحة 19)

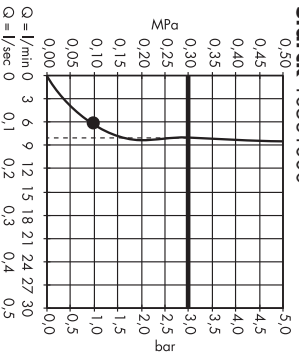
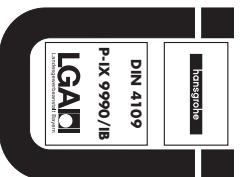
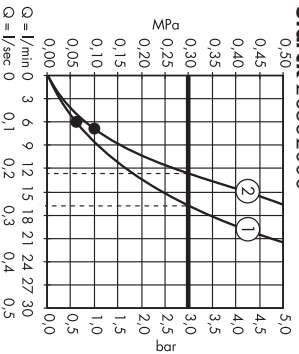
Starck 10531000**Starck 28532000**

	P-IX	DVGW	SVGW	ACS	WRAS	NF	KIWA
10531000	P-IX 19801/IA	X	X	X	X		X
28532000	P-IX 9990/IB	BR0047	X	X	X		X

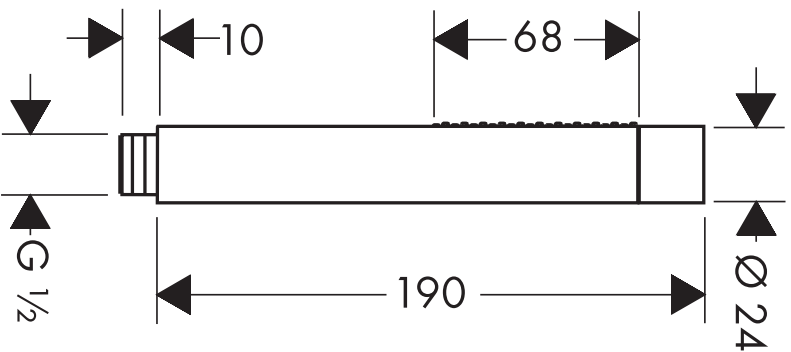
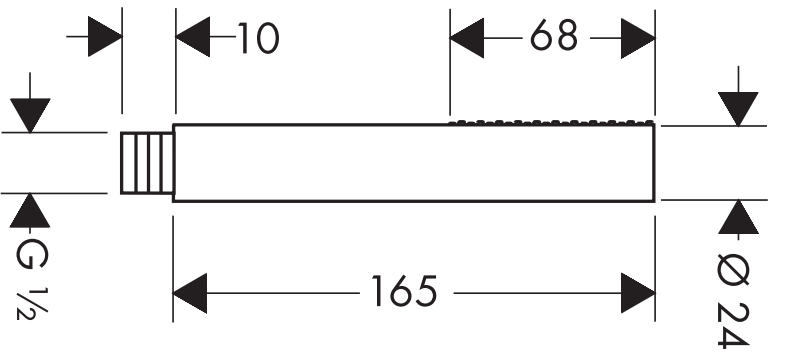

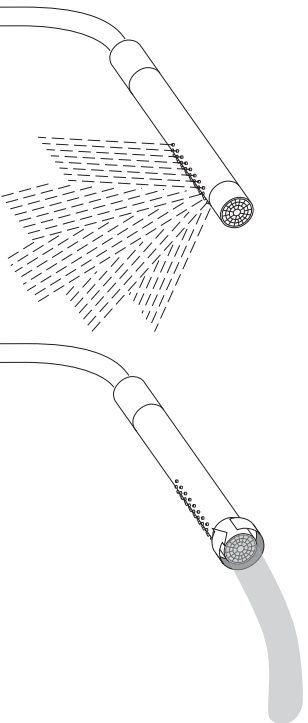
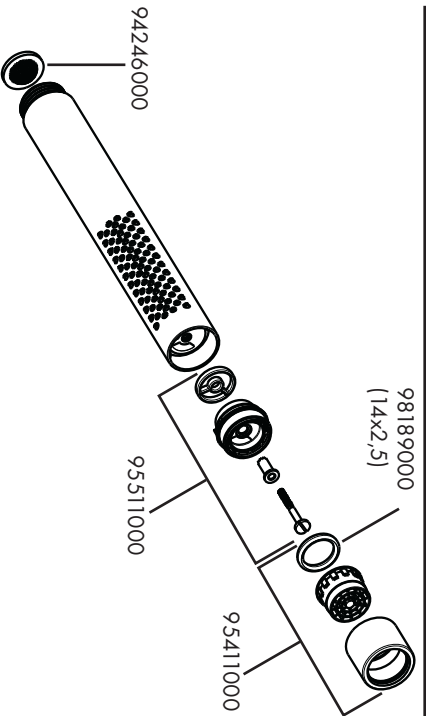
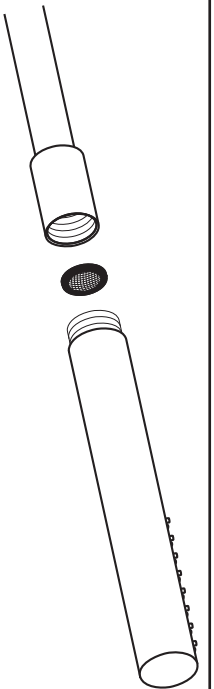

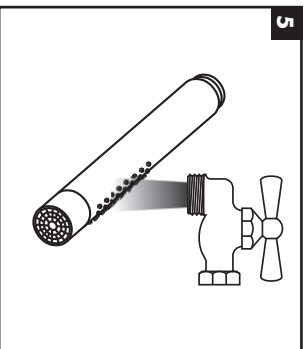
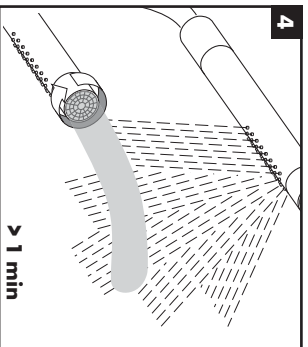
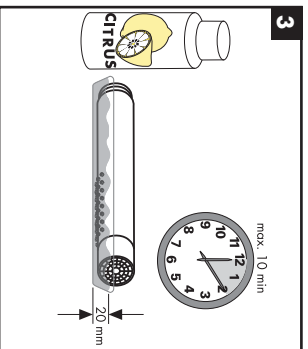
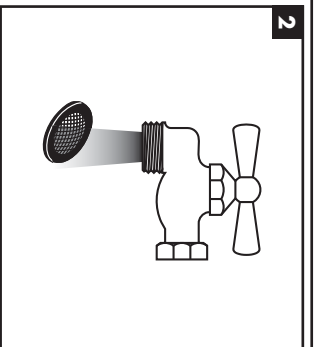
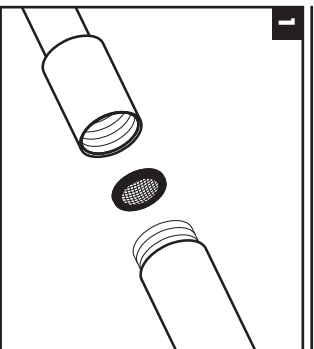

hansgröhe

02/2015
9.08378.04