

Installation Instructions / Warranty

FIX FIT STOP

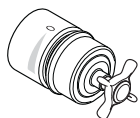

Montreux
16882XX1



Montreux
16883XX1

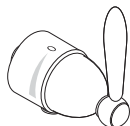

Carlton
17882XX1

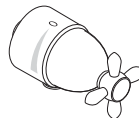

Carlton
17883XX1

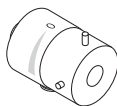

Starck
10882XX1

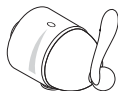

Phoenix
17982XX1

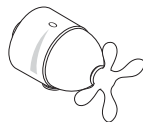

Phoenix
17983XX1

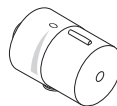

Steel
35882801

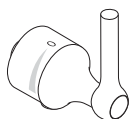

Terrano
37882XX1

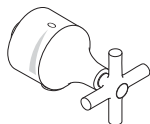

Terrano
37883XX1

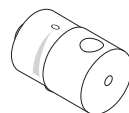

Uno
38882XX1

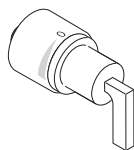

Citterio
39882XX1

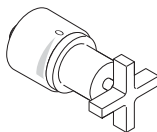

Citterio
39883XX1



27452XX1

AXOR[®]

hansgrohe

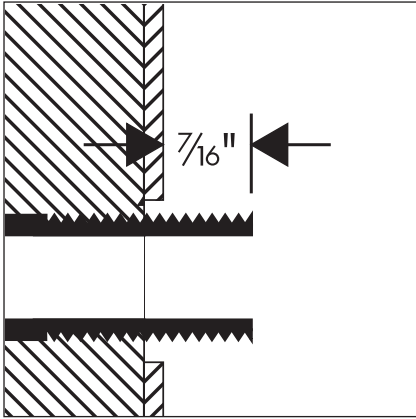

This unit requires a 1/2" NPT male nipple, extending 7/16" outside the surface of the finished wall.

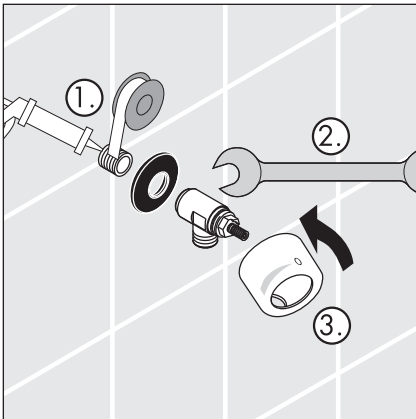

Seal the wall around the nipple with waterproof sealant.



Failure to seal the wall can lead to possible water damage.

Wrap the nipple with Teflon tape (1).

Position the flat seal over the nipple. Screw the elbow firmly onto the nipple (2). Test for leaks.

Slide the cover over the elbow and snap into place on the gasket (3).

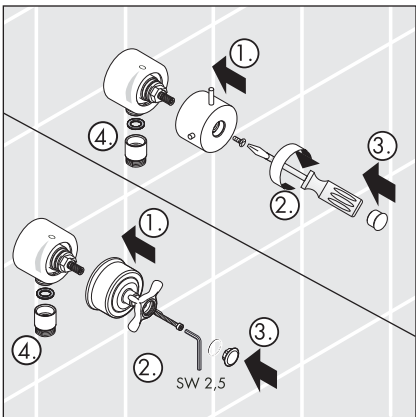

Handle assembly

10882XX1 Starck
37882XX1 / 37883XX1 Terrano
16882XX1 / 16883XX1 Montreux

Push the handle onto the stem (1).

Tighten the screw (2).

Install the screw cover (3).

Install the hose adapter and washer (4).

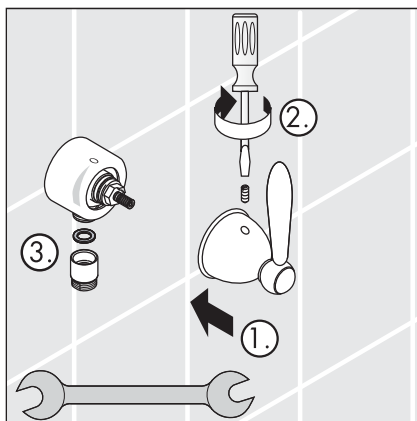

17885XX1 / 17886XX1 Carlton
17982XX1 / 17983XX1 Phoenix

Push the handle onto the stem (1).

Tighten the screw (2).

Install the hose adapter and washer (3).

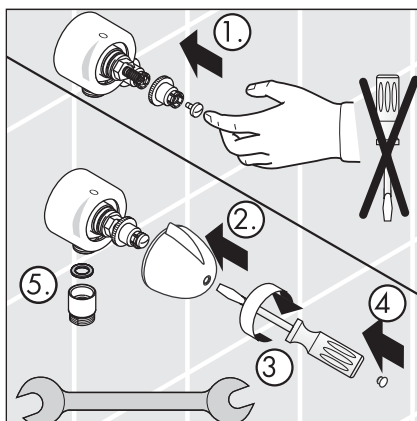

35882801 Steel
38882XX1 Uno
27452XX1

Tighten the screw by hand only three turns (1).

Snap on the handle (2).

Tighten the screw (3).

Cover the hole with the plastic cap (4).

Install the hose adapter and washer (5).

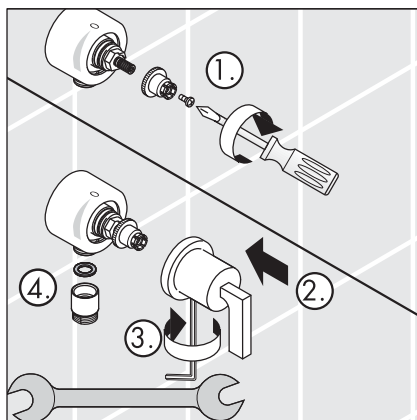

Citterio 39882XX1 / 39883XX1

Install the handle fixation and tighten the screw (1).

Snap on the handle (2).

Tighten the set screw with a 2 mm Allen wrench (3).

Install the hose adapter and washer (4).

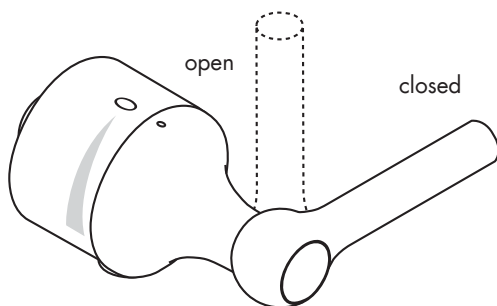

Replacement parts

1	cartridge		96350000
2	sleeve		96240XXX
3	flat seal		98557000
4	non return valve		94074000
5	handle	Starck	10993XX1
5.1	screw-cover	Starck	96540XX1
6	cross handle	Carlton	17993XX1
7	lever handle	Carlton	17298XX1
8	handle	Steel	35993801
8.1	screw-cover	Steel/Uno/27452XX1	96541001
9	handle	27452XX1	36993XX1
10	cross handle	Terrano	37995XX1
10.1	screw-cover	Terrano	96542XX0
11	lever handle	Terrano	37993XX1
11.1	screw-cover	Terrano	96543XX0
12	handle	Uno	38993XX1
13	lever handle	Citterio	39993XX1
14	cross handle	Citterio	39995XX1
15	lever handle	Phoenix	96632XX1
16	cross handle	Phoenix	96792XX1
17	cross handle	Montreux	16593XX0
17.1	screw-cover	Montreux	97987000
18	lever handle	Montreux	16693XX0

XX = Color code:

- 00 chrome
- 62 oil rubbed bronze
- 80 steel
- 81 satinox
- 82 brushed nickel
- 83 polished nickel

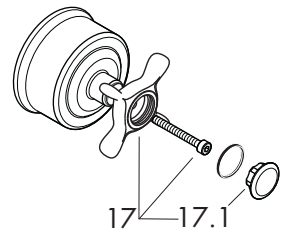
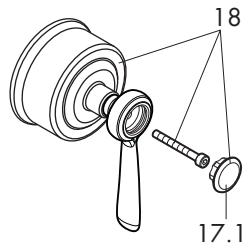
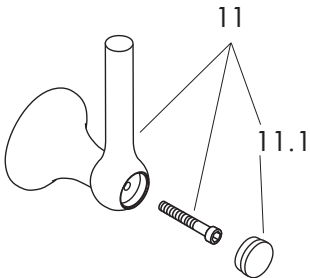
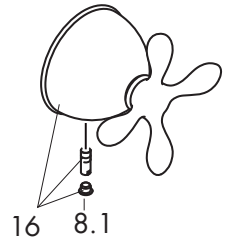
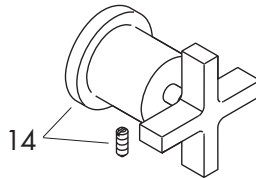
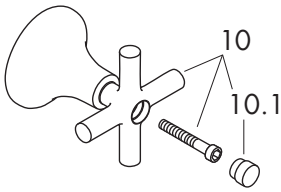
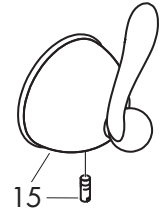
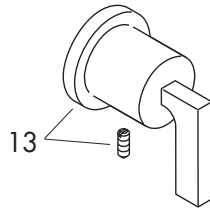
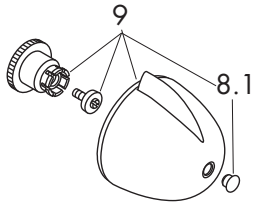
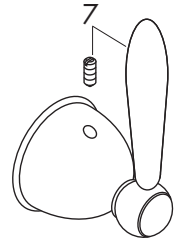
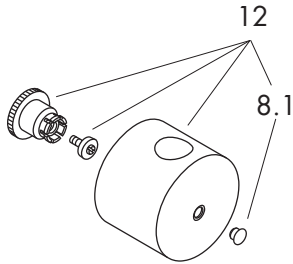
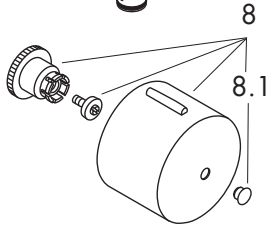
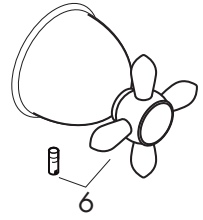
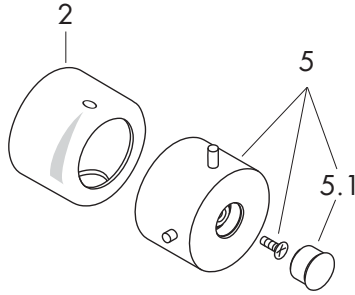
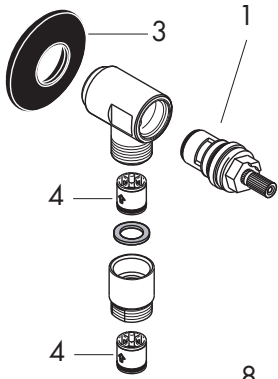

Cleaning Recommendation for Hansgrohe Products

Modern lavatory faucets, kitchen faucets, and showers consist of very different materials to comply with the needs of the market with regard to design and functionality. To avoid damage and returns, it is necessary to consider certain criteria when cleaning.

Cleaning Materials for Faucets and Showers

Acids are a necessary ingredient of cleaning materials for removing lime, however please pay attention to the following points when cleaning faucets and showers:

- Only use cleaning materials which are explicitly intended for this type of application.
- Never use cleaning materials which contain hydrochloric, formic, phosphoric, or acetic acid, as they cause considerable damage.
- Never mix one cleaning material with another.
- Never use cleaning materials or appliances with an abrasive effect, such as unsuitable cleaning powders, sponge pads, or micro fiber cloths.

Cleaning Instructions for Faucets and Showers

Please follow the cleaning material manufacturer's instructions. In addition, pay attention to the following points:

- Clean the faucets and showers as and when required
- Use the amount of cleaning product and the amount of time recommended by the manufacturer. Do not leave the cleaner on the fixture longer than necessary.
- Regular cleaning can prevent calcification.
- When using spray cleaners, spray first onto a soft cloth or sponge. Never spray directly onto the faucet as droplets can enter openings and gaps and cause damage.
- After cleaning, rinse thoroughly with clean water to remove any cleaner residue.

Important

Residues of liquid soaps, shampoos, and shower foams can also cause damage, so rinse with clean water after using.

Please note: if the surface is already damaged, the effect of cleaning materials will cause further damage.

Components with damaged surfaces must be replaced or injury could result.

Damage caused by improper treatment is not covered under the warranty.

Limited Lifetime Consumer Warranty

This product has been manufactured and tested to the highest quality standards by Hansgrohe, Inc. ("Hansgrohe"). This warranty is limited to Hansgrohe products which are purchased by a consumer in the United States after March 1, 1996, and installed in either the United States or Canada.

WHO IS COVERED BY THE WARRANTY

This warranty extends to the original consumer purchaser only. This warranty is non-transferable.

WHAT IS COVERED BY THE WARRANTY

This warranty covers only your Hansgrohe manufactured product. Hansgrohe warrants this product against defects in material or workmanship as follows: Hansgrohe will repair at no charge for parts only or, at its option, replace any product or part of the product that proves defective because of improper workmanship and/or material, under normal installation, use, service and maintenance. If Hansgrohe is unable to provide a replacement and repair is not practical or cannot be timely made, Hansgrohe may elect to refund the purchase price in exchange for the return of the product.

LENGTH OF WARRANTY

Replacement or repaired parts of products will be covered for the term of this warranty as stated in the following two sentences. If you are a consumer who purchased the product for use primarily for personal, family, or household purposes, this warranty extends for as long as you own the product and the home in which the product is originally installed. If you purchased

the product for use primarily for any other purpose, including, without limitation, a commercial purpose, this warranty extends only (i) for 1 year, with respect to Hansgrohe and Commercial products, and (ii) for 5 years, with respect to AXOR products.

THIS WARRANTY DOES NOT COVER, AND HANSGROHE WILL NOT PAY FOR:

- A. Conditions, malfunctions or damage not resulting from defects in material or workmanship.
- B. Conditions, malfunctions or damage resulting from (1) normal wear and tear, improper installation, improper maintenance, misuse, abuse, negligence, accident or alteration, or (2) the use of abrasive or caustic cleaning agents or “no-rinse” cleaning products, or the use of the product in any manner contrary to the product instructions. (3) Conditions in the home such as excessive water pressure or corrosion.
- C. Labor or other expenses for the disconnection, deinstallation, or return of the product for warranty service, or for installation or reinstallation of the product (including but not limited to proper packaging and shipping costs), or for installation or reinstallation of the product.
- D. Accessories, connected materials and products, or related products not manufactured by Hansgrohe.

TO OBTAIN WARRANTY PARTS OR INFORMATION

Contact your Hansgrohe retailer, or contact Technical Service at:

Hansgrohe Inc.
1492 Bluegrass Lakes Parkway
Alpharetta GA 30004
Toll-free (800) 334-0455.

In requesting warranty service, you will need to provide

- 1. The sales receipt or other evidence of the date and place of purchase.
- 2. A description of the problem.
- 3. Delivery of the product or the defective part, postage prepaid and carefully packed and insured, to Hansgrohe Inc. 1492 Bluegrass Lakes Parkway, Alpharetta, Georgia 30004, Attention: Technical Service, if required by Hansgrohe.

When warranty service is completed, any repaired or replacement product or part will be returned to you postage prepaid.

EXCLUSIONS AND LIMITATIONS

REPAIR OR REPLACEMENT (OR, IN LIMITED CIRCUMSTANCES, REFUND OF THE PURCHASE PRICE) AS PROVIDED UNDER THIS WARRANTY IS THE EXCLUSIVE REMEDY OF THE PURCHASER. HANSGROHE NEITHER ASSUMES NOR AUTHORIZES ANY PERSON TO CREATE FOR IT ANY OBLIGATION OR LIABILITY IN CONNECTION WITH THIS PRODUCT.

HANSGROHE SHALL NOT BE LIABLE TO PURCHASER OR ANY PERSON FOR ANY INCIDENTAL, SPECIAL, OR CONSEQUENTIAL DAMAGES, ARISING OUT OF BREACH OF THIS WARRANTY OR ANY IMPLIED WARRANTY (INCLUDING MERCHANTABILITY).

Some States do not allow the exclusion or limitation of incidental or consequential damages, so the above limitation or exclusion may not apply to you. This warranty gives you specific legal rights, and you may have other rights which vary from State to State. You may be required by law to give us a reasonable opportunity to correct or cure any failure to comply before you can bring any action in court against us under the Magnuson-Moss Warranty Act.

PRODUCT INSTRUCTIONS AND QUESTIONS

Upon purchase or prior to installation, please carefully inspect your Hansgrohe product for any damage or visible defect. Prior to installing, always carefully study the enclosed instructions on the proper installation and the care and maintenance of the product. If you have questions at any time about the use, installation, or performance of your Hansgrohe product, or this warranty, please call or write to us or call us toll-free at 800 334 0455.

hansgrohe

Hansgrohe, Inc. • 1490 Bluegrass Lakes Parkway • Alpharetta, GA 30004
Tel. 770-360-9880 • Fax 770-360-9887

www.hansgrohe-usa.com