

# AVE

L I G H T I N G

HF9208-BLK

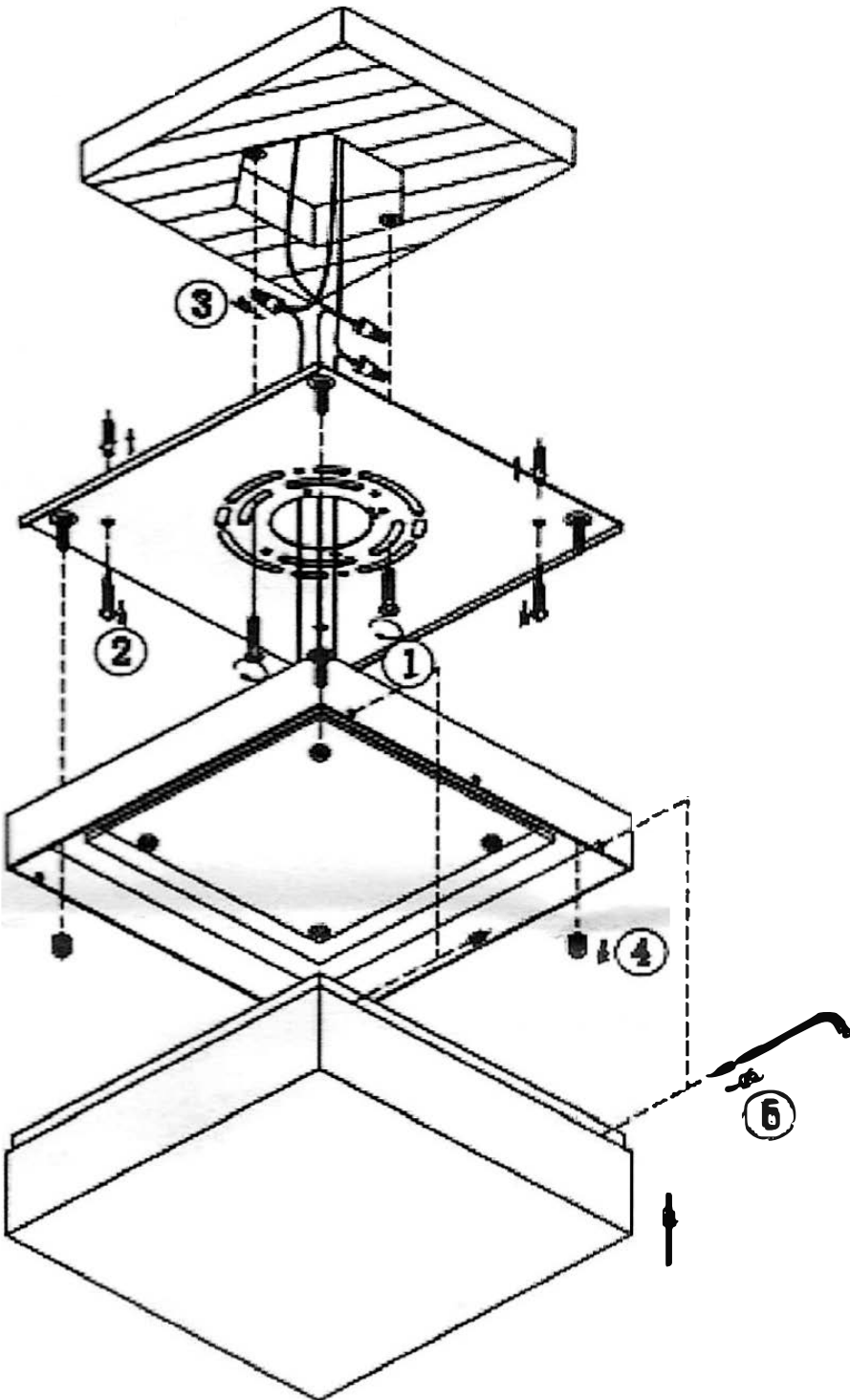

**A:** Copper ground wire to ground wire-if you only have two wires coming from the electrical box,connect the fixture's copper wire to the green ground screw on the mounting plate.

**B:** White fixture wire to white supply wire.

**C:** Black Fixture wire to black supply wire.