

HF3901-BK

AVE

L I G H T I N G

Fixture Style

Thank you for your purchase.

Welcome to the Avenue Lighting Family. Please follow these instructions carefully as they contain important information about the safety, use and disposal of this product. Read and understand all instructions before proceeding with assembly and installation of this fixture.

- This fixture **MUST** be installed by a licensed electrician.
- Read & understand the entire installation sheet.
- DO NOT substitute any parts, leave parts out, or use parts that are worn out or broken.
- Suitable for the use of 110-130V and 60Hz
- Please wear gloves during installation to avoid damage to the plating.
- Must be installed in a fixed location and be checked yearly.
- Please turn off the light source with a soft cloth as cleaning with a detergent is prohibited.

Preparation:

Carefully remove the fixture from the carton and check that all parts are included as shown in the illustration. If any parts are missing or damaged, DO NOT attempt to assemble the product.

Tools Required (not included):

Phillips screwdriver	Electrical Tape
Flathead screwdriver	Ladder
Wire Strippers	Safety Glasses

This package includes:

2 x Junction Box Screws
3 x Wire Connectors

Assembly Instructions:

1. Please turn off the power before installing the lamp [see figure A]
2. Remove the mounting bracket from the top box, then place the mounting bracket on the junction box. Next tighten with the junction box screw.
3. Connect the NEUTRAL WIRE from junction box to NEUTRAL (WHITE) wire from fixture with a wire nut. Connect the LIVE WIRE from junction box to LIVE (BLACK) wire from fixture with a wire nut.
4. Wrap the naked copper in the junction box around the green screw. Lock the green screw in the tooth hole. Connect the grounding wire of the lamp and the naked copper of the junction box with the terminal.
5. Secure the canopy to the mounting plate using the mounting screws.
6. Please hold down the bottom of the wire lock and slowly push or pull the cable upwards or downward to form desired layout of full unit.
7. Turn on the power [see figure B]

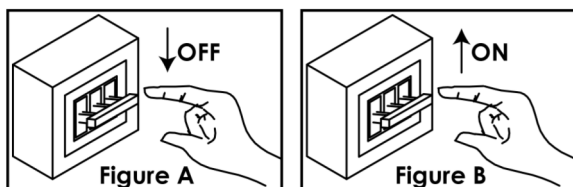
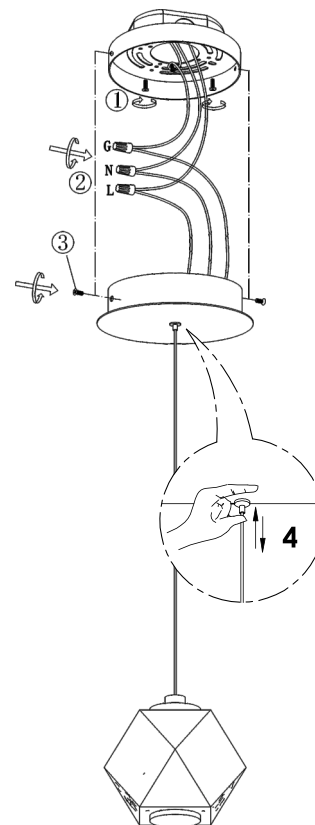
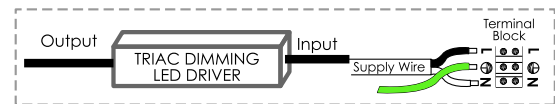

Clean with a soft damp cloth.

www.AvenueLighting.com



Intertek
5028385