

Aston Bromley SEN967-5323

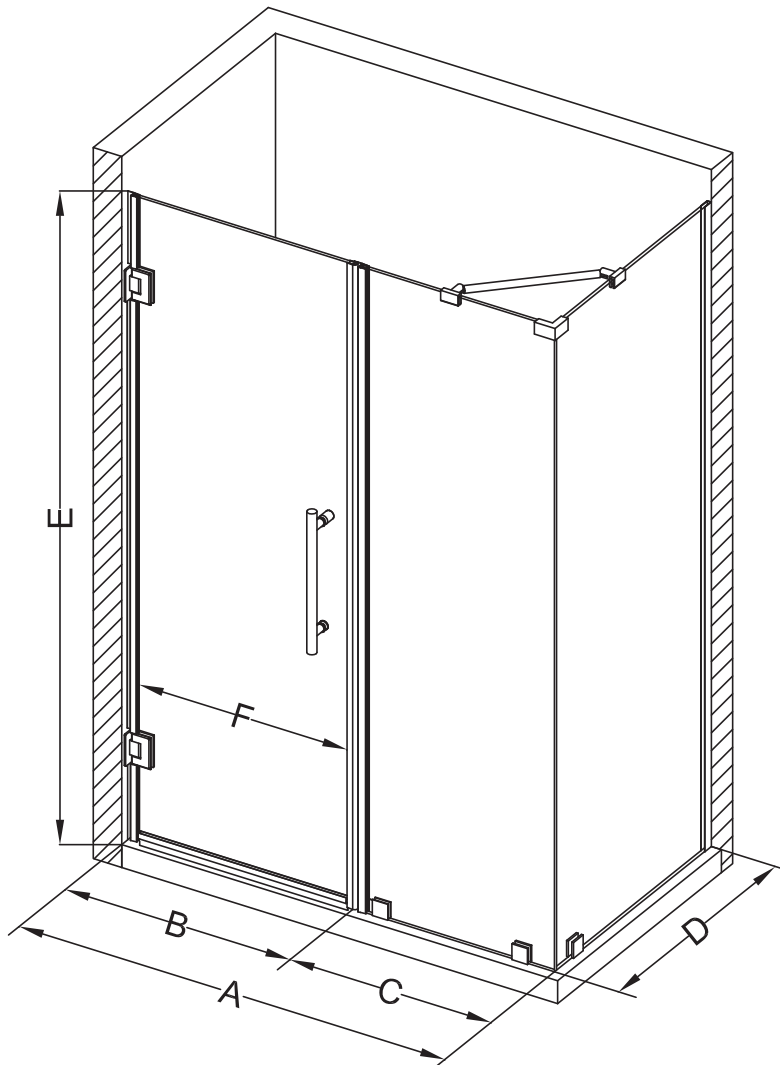

MODEL	WALL OPENING (A)	DOOR PANEL (B)	FIXED PANEL (C)	RETURN PANEL (D)	HEIGHT (E)	DOOR WALK THROUGH (F)
SEN967-532330-10	52 1/4" - 53 1/4"	22 5/8"	29 5/8"	30" - 30 3/8"	72"	20 5/8" - 21 5/8"
SEN967-532332-10	52 1/4" - 53 1/4"	22 5/8"	29 5/8"	32" - 32 3/8"	72"	20 5/8" - 21 5/8"
SEN967-532334-10	52 1/4" - 53 1/4"	22 5/8"	29 5/8"	34" - 34 3/8"	72"	20 5/8" - 21 5/8"
SEN967-532336-10	52 1/4" - 53 1/4"	22 5/8"	29 5/8"	36" - 36 3/8"	72"	20 5/8" - 21 5/8"
SEN967-532338-10	52 1/4" - 53 1/4"	22 5/8"	29 5/8"	38" - 38 3/8"	72"	20 5/8" - 21 5/8"

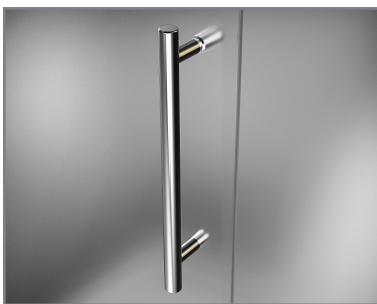

POLISHED CHROME



STAINLESS STEEL

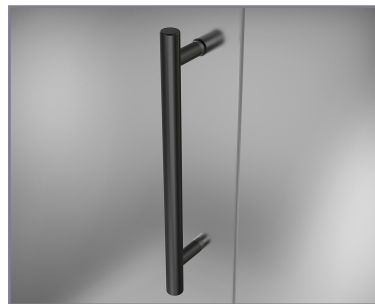

OIL RUBBED BRONZE



CLEAR GLASS



CH CHROME HARDWARE

SS STAINLESS STEEL HARDWARE

ORB OIL RUBBED BRONZE HARDWARE



REVERSIBLE DOOR

ASTON
STARCAST
FROM **EnduroShield**

ASTON
ESCAPE THE EVERYDAY