

# Aston Bromley SEN967-5036

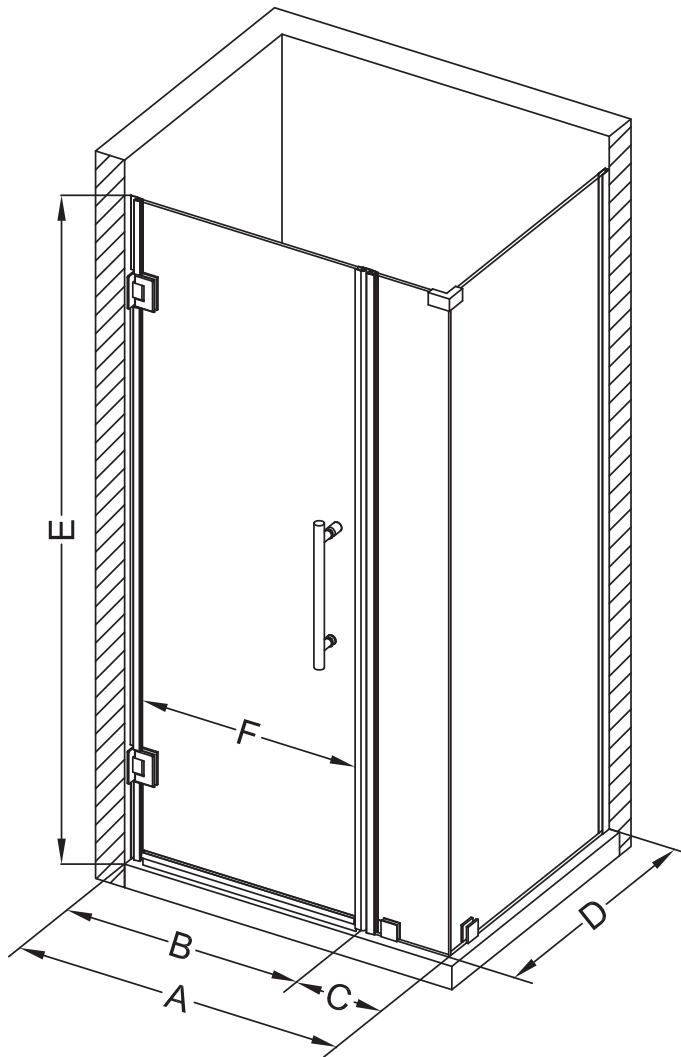

MODEL	WALL OPENING (A)	DOOR PANEL (B)	FIXED PANEL (C)	RETURN PANEL (D)	HEIGHT (E)	DOOR WALK THROUGH (F)
SEN967-503630-10	49 1/4"-50 1/4"	35 5/8"	13 5/8"	30"-30 3/8"	72"	33 5/8"-34 5/8"
SEN967-503632-10	49 1/4"-50 1/4"	35 5/8"	13 5/8"	32"-32 3/8"	72"	33 5/8"-34 5/8"
SEN967-503634-10	49 1/4"-50 1/4"	35 5/8"	13 5/8"	34"-34 3/8"	72"	33 5/8"-34 5/8"
SEN967-503636-10	49 1/4"-50 1/4"	35 5/8"	13 5/8"	36"-36 3/8"	72"	33 5/8"-34 5/8"
SEN967-503638-10	49 1/4"-50 1/4"	35 5/8"	13 5/8"	38"-38 3/8"	72"	33 5/8"-34 5/8"



POLISHED CHROME



STAINLESS STEEL



OIL RUBBED BRONZE



CLEAR GLASS



**CH** CHROME HARDWARE

**SS** STAINLESS STEEL HARDWARE

**ORB** OIL RUBBED BRONZE HARDWARE



REVERSIBLE DOOR

ASTON  
**STARCAST**  
FROM **EnduroShield**

**ASTON**  
ESCAPE THE EVERYDAY