

Aston Bromley GS SEN962-7034

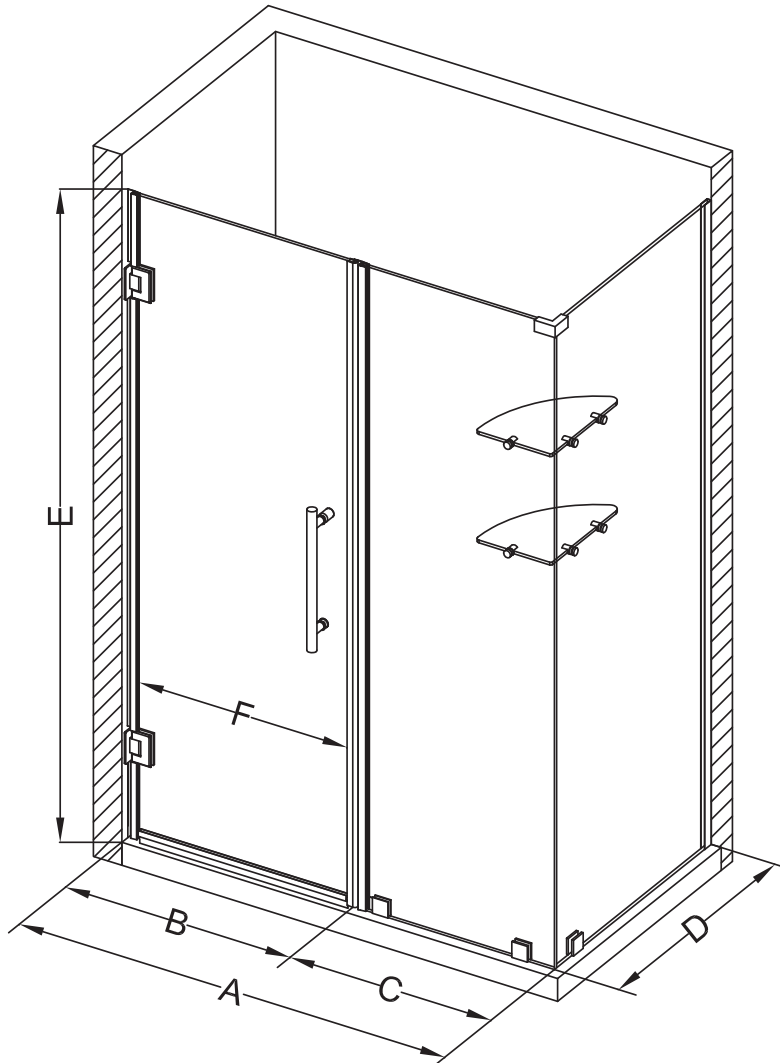

| MODEL | WALL OPENING (A) | DOOR PANEL (B) | FIXED PANEL (C) | RETURN PANEL (D) | HEIGHT (E) | DOOR WALK THROUGH (F) |
|------------------|------------------|----------------|-----------------|------------------|------------|-----------------------|
| SEN962-703430-10 | 69 1/4"-70 1/4" | 33 5/8" | 35 5/8" | 30"-30 3/8" | 72" | 31 5/8"-32 5/8" |
| SEN962-703432-10 | 69 1/4"-70 1/4" | 33 5/8" | 35 5/8" | 32"-32 3/8" | 72" | 31 5/8"-32 5/8" |
| SEN962-703434-10 | 69 1/4"-70 1/4" | 33 5/8" | 35 5/8" | 34"-34 3/8" | 72" | 31 5/8"-32 5/8" |
| SEN962-703436-10 | 69 1/4"-70 1/4" | 33 5/8" | 35 5/8" | 36"-36 3/8" | 72" | 31 5/8"-32 5/8" |
| SEN962-703438-10 | 69 1/4"-70 1/4" | 33 5/8" | 35 5/8" | 38"-38 3/8" | 72" | 31 5/8"-32 5/8" |



POLISHED CHROME



STAINLESS STEEL



OIL RUBBED BRONZE



CLEAR GLASS



CH CHROME HARDWARE

SS STAINLESS STEEL HARDWARE

ORB OIL RUBBED BRONZE HARDWARE



ASTON
STARCAST
FROM
EnduroShield

ASTON
ESCAPE THE EVERYDAY