

# Aston Bromley GS SEN962-6022

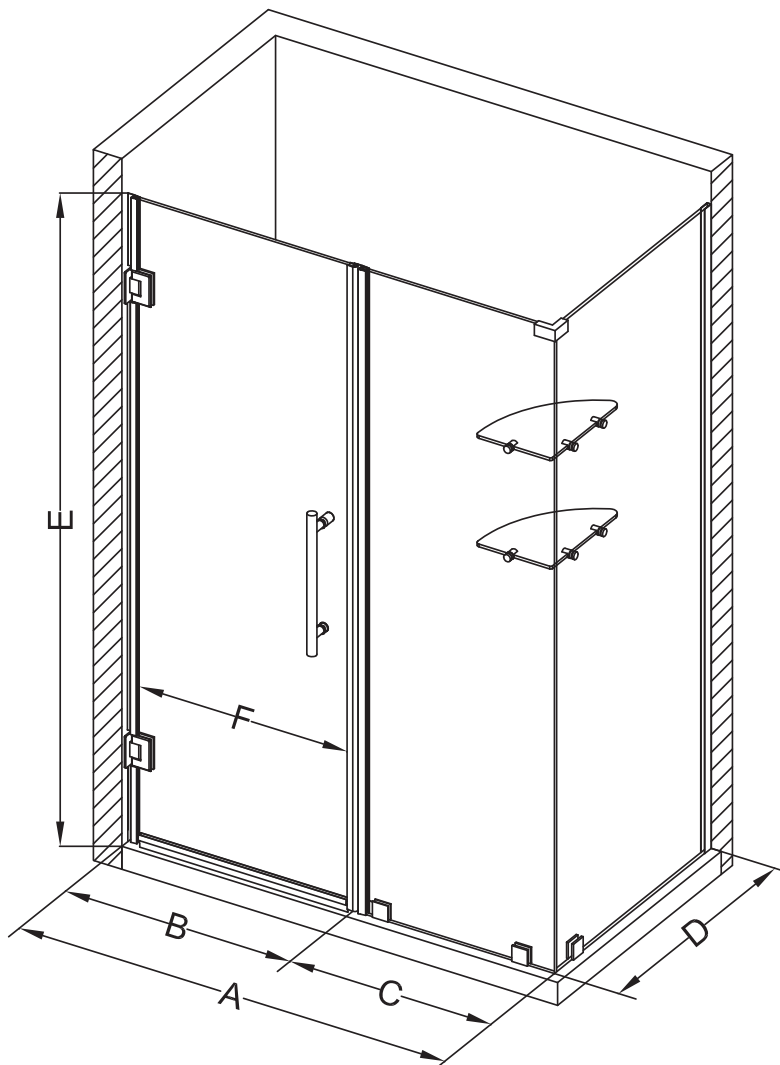

MODEL	WALL OPENING (A)	DOOR PANEL (B)	FIXED PANEL (C)	RETURN PANEL (D)	HEIGHT (E)	DOOR WALK THROUGH (F)
SEN962-602230-10	59 1/4"-60 1/4"	21 5/8"	37 5/8"	30"-30 3/8"	72"	19 5/8"-20 5/8"
SEN962-602232-10	59 1/4"-60 1/4"	21 5/8"	37 5/8"	32"-32 3/8"	72"	19 5/8"-20 5/8"
SEN962-602234-10	59 1/4"-60 1/4"	21 5/8"	37 5/8"	34"-34 3/8"	72"	19 5/8"-20 5/8"
SEN962-602236-10	59 1/4"-60 1/4"	21 5/8"	37 5/8"	36"-36 3/8"	72"	19 5/8"-20 5/8"
SEN962-602238-10	59 1/4"-60 1/4"	21 5/8"	37 5/8"	38"-38 3/8"	72"	19 5/8"-20 5/8"



POLISHED CHROME

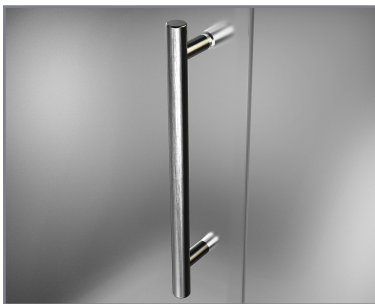

STAINLESS STEEL



OIL RUBBED BRONZE



CLEAR GLASS



**CH** CHROME HARDWARE

**SS** STAINLESS STEEL HARDWARE

**ORB** OIL RUBBED BRONZE HARDWARE



ASTON **STARCAST**  
FROM **EnduroShield**

**ASTON**  
ESCAPE THE EVERYDAY