

USER MANUAL

Dishwasher

EN

DBI565IXXLS.U

DBI565TXXLS.U

DBI565THXXLS.U

DBI565PHXXLS.U

DBI565PXXLS.U

Contents

Your dishwasher	3	WiFi connection	25
Important safety instructions	4	Connect Life	25
FCC declaration of conformity	4	Preparations	25
FCC radiation exposure statement	4	Connect to a network and pair	25
General	4	Remote control the dishwasher	26
Child safety	5	Remote start the dishwasher	26
Child lock	5	Pair more devices	26
Installation	5	Turn off existing WiFi / Turn on existing	
Overflow guard	5	WiFi	26
Winter storage/Transport	5	Remove all devices	26
Packing material	5	Settings	27
Disposal	6	Care and maintenance instructions	30
Symbols	6	Add rinse aid	30
Before washing for the first time	7	Clean the filters	30
Water hardness	7	Cleaning the spray arms	31
Basic settings	7	Clean the outside of the dishwasher	32
Add rinse aid	8	Run Self-cleaning	33
Greener dishwashing	9	Remove blockages	33
Save energy and water	9	Troubleshooting	34
Loading the dishwasher	10	General	35
Fragile dishes	10	WiFi	41
Loading affects the results	10	Installation instructions	43
The dishwasher's baskets	11	Important safety instructions	43
Top cutlery tray	11	Transport protection for the door	44
Upper basket	12	Trim kit	44
Lower basket	14	Placing the dishwasher	44
Cutlery basket	16	Fit the protective film	45
Typical load	17	Adjust the height and slide the dishwasher	
Using the dishwasher	18	into place	45
Add detergent	18	Drain connection	47
On/Off	19	Connection to water supply	48
Select program	19	Electrical connection	48
Select program mode	20	Screwing the dishwasher into place	49
Select option	21	Dishwasher toe kick	50
Start/Stop	21	Service and warranty	51
Status light	22	Limited Warranty – Residential Appliances ..	51
If you want to load more dishes	22	Items excluded from warranty	51
Power failure	23	Disclaimer	51
Once the program has finished	23	ASKO Customer Care	52
The best drying results	23	Service after expiration of limited warranty ..	52
Unloading the dishwasher	23	Number of cycles	52
Program chart	24	Technical information	53
		Technical data	53

Your dishwasher

Welcome to our growing ASKO family!

We are proud of our appliances. We hope that this appliance will be an appreciated and dependable device for many years to come.

Please read the operating instructions before use. They include general tips, information about the settings and adjustments you can make, and the best way to take care of your appliance.

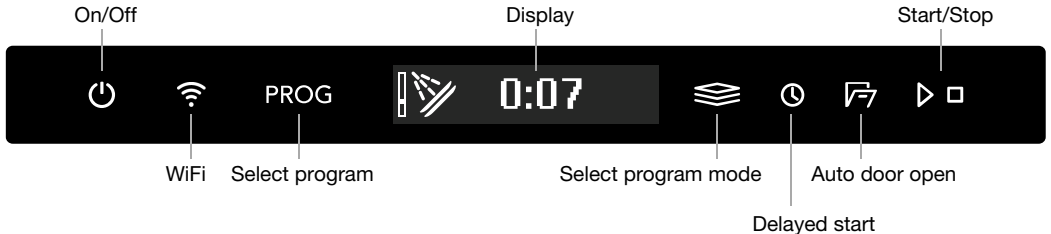

Symbols on the display:

- ☞ Auto door open
- * Add rinse aid

- 📶 Connected to cloud (Flashes when connecting)
- 📶 Remote control active

Text on the display:

- Clean the filters
- Run Self-cleaning
- See the chapter *Care and maintenance instructions*.

Install the dishwasher; see the chapter *Installation instructions*. Then open the door and press .

"Welcome to your ASKO. First time setup." is shown on the display the first time the dishwasher is switched on. It is important that you choose the right settings to ensure good dishwashing results. See page 7.

You can remote control this dishwasher with your smartphone/tablet. Connect the dishwasher to your wireless network and pair with your smartphone/tablet to be able to remote control and start the dishwasher using the *Connect Life* app. The app can be used to find information, change settings, and monitor the dishwasher. (The dishwasher can always be used without the app.)

Important safety instructions

SAVE THESE INSTRUCTIONS FOR FUTURE REFERENCE

WARNING!

When using your dishwasher, follow basic precautions, including the following:

- Read all instructions before using the dishwasher.
- Use the dishwasher only for its intended purpose.
- Use only detergents or rinse agents recommended for use in a dishwasher and keep them out of the reach of children.
- When loading items to be washed:
 - position sharp items so that they are not likely to damage the door seal, and
 - load sharp knives with the handles up to reduce the risk of cut-type injuries.
- Do not wash plastic items unless they are marked “dishwasher safe” or the equivalent. For plastic items not so marked, check the manufacturer’s recommendations.
- Do not operate the dishwasher unless all enclosure panels are properly in place.
- Do not tamper with controls.
- Do not abuse, sit on, or stand on the door or dish rack of the dishwasher.
- To reduce the risk of injury, do not allow children to play in or on a dishwasher.
- Under certain conditions, hydrogen gas may be produced in a hot water system that has not been used for two weeks or more. HYDROGEN GAS IS EXPLOSIVE. If the hot water system has not been used for two weeks, before using the dishwasher turn on all hot water faucets and let the water flow from each for several minutes. This will release any accumulated hydrogen gas. As the gas is flammable, do not smoke or use an open flame during this time.
- Remove the door of the dishwasher when removing the dishwasher from service or discarding it (so that children cannot become trapped inside).
- Read the grounding instructions in the installation instructions.

FCC declaration of conformity

This device complies with part 15 of the FCC Rules. Operation is subject to the condition that this device does not cause harmful interference.

FCC radiation exposure statement

This equipment complies with FCC radiation exposure limits set forth for an uncontrolled environment. This equipment should be installed and operated with a minimum distance of 8” (20 cm) between the radiator and your body.

General

- Do not run the dishwasher while you are out of the home.
- Do not store or use combustible materials, gasoline, or other flammable vapors and liquids in the vicinity of this or any other appliance.
- Disconnect electrical power to dishwasher before servicing.
- Repairs should be done by a qualified technician.

Important safety instructions

WARNING!

PROPOSITION 65 FOR CALIFORNIA RESIDENTS

Cancer and Reproductive Harm – www.P65Warnings.ca.gov



Child safety

- Always keep small children away from the machine when it is open. There may be some detergent residue left inside the machine.
- Always close the door and start the dishwasher as soon as you put in the detergent.
- If dishwasher detergent gets in someone's eyes, rinse them with plenty of water for at least 15 minutes.
- Should a child swallow dishwasher detergent or rinse aid, give plenty to drink immediately, i.e., one or two glasses of milk or water. Do not try to induce vomiting. Seek medical advice immediately: Call the National Poison Control Center at 1-800-222-1222.

WARNING!

Dishwasher detergents and rinse aids are corrosive, so always keep them out of reach of children.

Child lock

You can activate the Automatic child lock setting to prevent children from starting the dishwasher. See the chapter *Settings*. You can also temporarily activate and deactivate the Child lock function. Press and hold  and  for three seconds.

Installation

See the chapter *Installation instructions*.

Overflow guard

The overflow guard starts pumping out the water and turns off the water supply if the water level in the dishwasher exceeds the normal level. If the overflow guard is triggered, F54 (Overfilling water) appears on the display. Turn off the water supply valve and contact your nearest Customer Care Center. (To avoid water leakage outside the dishwasher, do not remove the plug from the power outlet until the water supply valve has been turned off!)

Winter storage/Transport

Store the dishwasher above freezing and avoid long transport distances in very cold weather. Transport the dishwasher upright or laying on its back.

Before transporting a used dishwasher, or before prolonged storage, water must first be drained from the machine.

Packing material

The outer packaging protects the product during transport. The packaging material is recyclable. Separate the different packaging materials to help reduce raw material use and waste. Your dealer

Important safety instructions

can take the packaging for recycling or direct you to the nearest recycling center. The packaging is comprised of:

- Corrugated cardboard made from up to 100% recycled material.
- Expanded polystyrene (EPS) with no added chlorine or fluorine.
- Supports made from untreated wood.
- Protective plastic made from polyethylene (PE).

Disposal

The dishwasher is manufactured and labeled for recycling. When the machine has reached the end of its service life and is to be disposed of, it should immediately be made unusable. Pull out the power cord and cut it as short as possible.

Contact your municipality for information about where and how your dishwasher can be recycled correctly.

Symbols

Explanation of symbols that may appear on the appliance.



Read the user manual.

Before washing for the first time

Water hardness

In order to achieve good dishwashing results, the dishwasher needs soft water (water with low mineral content). Hard water leaves a white coating on dishes and the dishwasher.

Checking water hardness

Contact the local water utility to check the water hardness in your area. This is important to determine how much detergent and rinse aid to use.

In general, more rinse aid and detergent are needed for hard water.

Basic settings

Open the door. Press .

"**Welcome to your ASKO. First time setup.**" is shown on the display. It is important that you choose the right settings to ensure good dishwashing results.

Select setting with **PROG**. Confirm selected setting with .

Settings		
1.	Language	Select the language to be shown on the display.
2.	Set level of rinse aid 0/1/2/3/4/5 Default: 4	Use rinse aid to improve wash and dry times. Also use rinse aid to achieve clear and spotless results. The rinse aid dispenser can be adjusted between 0 (Off) and 5 (High dosage).
3.	TAB On/Off Default: Off	Activate this setting when using an all-in-one detergent that contains rinse aid. This setting reduces the rinse aid dosage.

To change the chosen setting, see the chapter *Settings*.

Before washing for the first time

* Add rinse aid

Fill up the rinse aid compartment with rinse aid if you have selected Rinse aid 1 - 5.

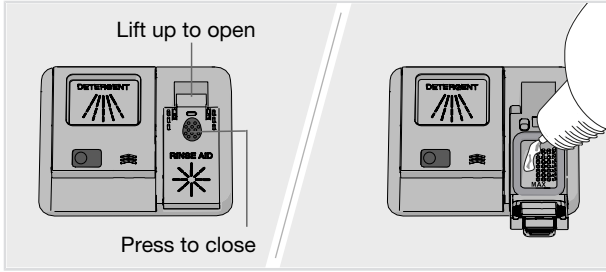

1. Open the rinse aid compartment lid.
2. Carefully fill up with rinse aid to the level marked **MAX**.
3. Wipe up any spilled rinse aid around the compartment.
4. Close the lid firmly.

Save energy and water

When using a dishwasher in a residential setting, less energy and water are generally used compared to washing the dishes by hand.

Do not rinse under running water

Do not rinse the dishes under running water as this will lead to increased energy and water consumption. Simply scrape off large food particles before loading the dishwasher.

Choose a green detergent

Read the environmental declaration on the packaging!

Too much detergent and rinse aid can result in less effective dishwashing and lead to a greater environmental impact.

Run a fully loaded dishwasher

Save energy and water by waiting until the dishwasher is full before running a program. Use the Rinse and hold program to rinse the dishes if there are any unpleasant odors.

You can also use the Anti-odor program to prevent bad odors from dirty dishes left in the dishwasher.

Run programs at a lower temperature

If the dishes are only lightly soiled, you can select a program with a lower temperature.

Select dishwashing program – Eco

This program is the most effective in terms of energy consumption.

Select program mode – Green

The dishwasher has different program modes. To save energy and water, use Green. (Available with: Normal)

Select option – Auto door open

Better drying results are achieved if you use the Auto door open option, which automatically opens the dishwasher door. Wait until the dishwasher indicates that the program has ended and the dishes have cooled before unloading the dishwasher.

Connect to cold water

Connect the dishwasher to the cold water supply if the building is heated using oil, electricity, or gas.

Connect to hot water

Connect the dishwasher to the hot water supply (max. 160 °F (70 °C)) if the building is heated using an energy-efficient means such as district heating, solar power, or geothermal power. Choosing a hot water connection reduces the dishwasher's energy consumption.

NOTE!

Do not exceed the permitted water supply temperature. Certain materials used in some cookware cannot withstand high temperatures. See *Fragile dishes* in the chapter *Loading the dishwasher*.

Loading the dishwasher

Fragile dishes

Some cookware is not dishwasher safe. This can be for several reasons. Some materials cannot withstand high temperatures, others can be damaged by dishwasher detergent.

Use caution with, for example, handmade items, China, crystal/glassware, silver, copper, tin, aluminum, wood, and plastic. Look for the "Dishwasher safe" marking.

China

Porcelain with decoration on top of the glazing (the items feel rough) should not be washed in a dishwasher.

Crystal/Glass

Use rinse aid to improve wash and dry times. Also use rinse aid to achieve clear and spotless results.

Hand-painted glassware, as well as antique and very fragile items, should not be washed in a dishwasher.

Silver

Silver and stainless steel items should not come into contact, as the silver can become discolored.

In order to avoid marks and tarnishing, separate dishes made from different metals, such as silver, stainless steel, and aluminum.

Aluminum

Aluminum can lose its shine if washed in a dishwasher. However, good quality aluminum pans can be washed in a dishwasher, even if some of the shine will be lost.

Cutlery with glued handles

Some types of glue are not dishwasher safe. In such cases, the handles may loosen.

Loading affects the results

Load the dishes carefully to ensure the best washing and drying results with the lowest possible energy and water consumption. Give your dishwasher the best chance to reach and clean all surfaces, as well as to dry the dishes as thoroughly as possible.

- All dirty surfaces should face in and down.
- Dishes should not be placed in or on each other.
- Angle dishes with hollows, such as cups, so that the rinse water will run off. This is also important for plastic items.
- Place the upper basket in its highest position when dishwashing very large plates.
- Make sure small items cannot fall through the dishwasher basket; place them in the top cutlery tray.

NOTE!

Check that the spray arms can rotate freely.

The dishwasher's baskets

The dishwasher includes a top cutlery tray, an upper basket, and a lower basket with a cutlery basket.

The basket appearance may differ depending on the configuration.

Top cutlery tray

The top cutlery tray accommodates cutlery, ladles, whisks, and other utensils.

Avoid placing tall objects in the top cutlery tray. They can block the top spray arm.

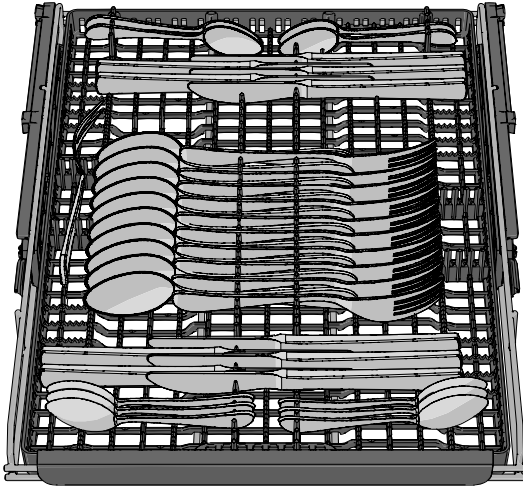

Raising the top cutlery tray

1. Pull out the top cutlery tray.
2. Pull the two locking handles forward on each side to raise the top cutlery tray.

Lowering the top cutlery tray

1. Make sure the upper basket is in the lowest position.
2. Pull out the top cutlery tray.
3. Slide the two locking handles down and back to lower the top cutlery tray.

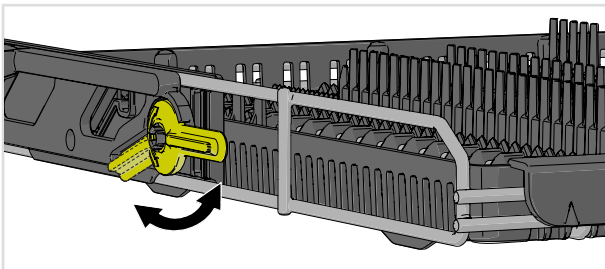

Loading the dishwasher

Upper basket

Place glasses, cups, bowls, side plates, and saucers in the upper basket. Place all soiled surfaces face down. Place wine glasses on the wine glass shelf. Place knives in the knife stand on the right.

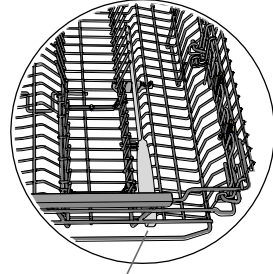
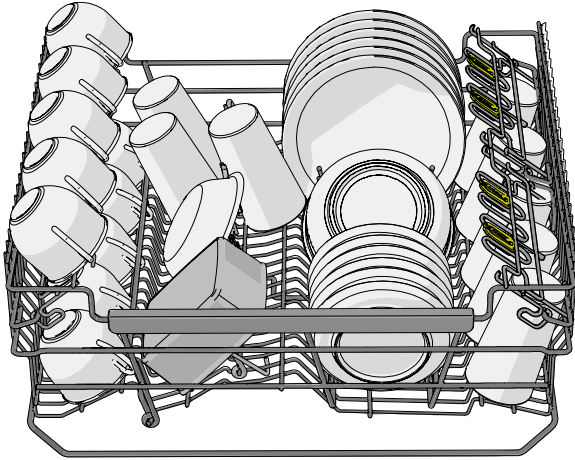

Knife stand

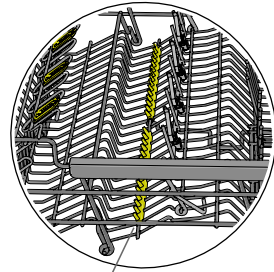
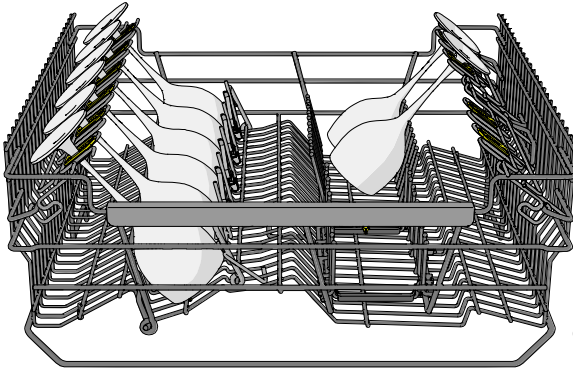

Extra supports for wine glasses can be fitted. (Inside the enclosed plastic bag.)

Adjustable plate supports

The adjustable plate supports can be pushed together to suit the dishes.

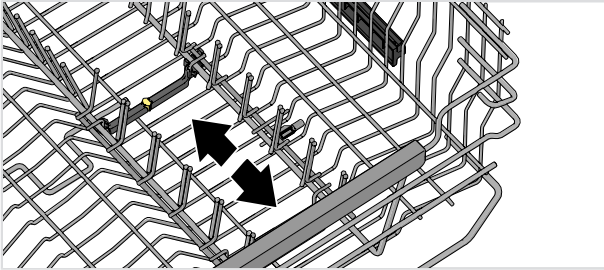

Raising the upper basket

1. Pull out the upper basket.
2. Grab the sides of the upper basket with both hands and lift it up.

Lowering the upper basket

1. Pull out the upper basket.
2. Grab the sides of the upper basket with both hands and push in the two locking handles to lower the upper basket.

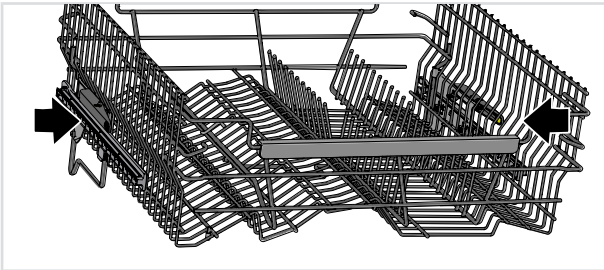

Loading the dishwasher

Lower basket

Place plates, side plates, serving dishes, pots, and cutlery (in the cutlery basket) in the lower basket.

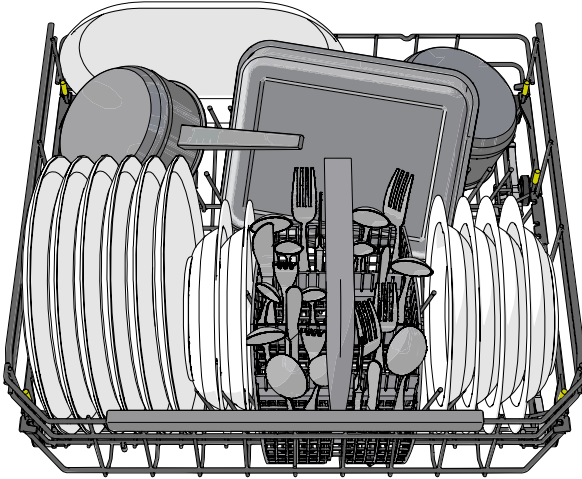

Adjustable plate supports

The adjustable plate supports can be adjusted to suit the dishes. Release the plate supports by pushing them inward before repositioning them. The plate supports can also be folded down to make it easier to load pots and bowls.

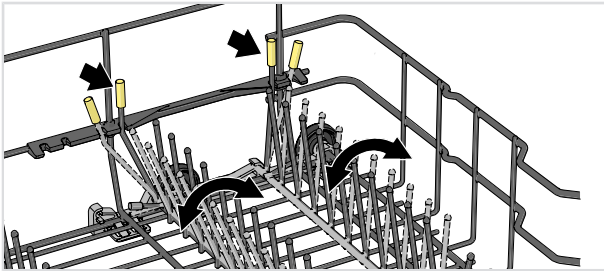

At the back of the right side of the lower basket, the plate supports can be pushed together to provide more space for, say, stoneware or a large pan.

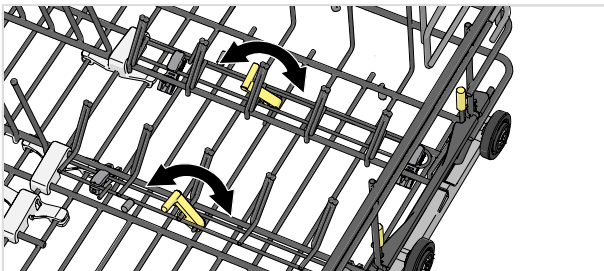

Loading the dishwasher

Vase and bottle holder

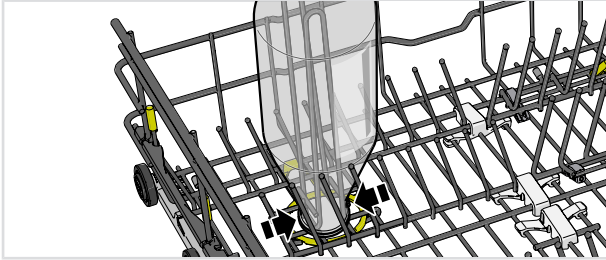

Adaptable power zones

The dishwasher's two adaptable power zones can be opened in two different positions or turned off.

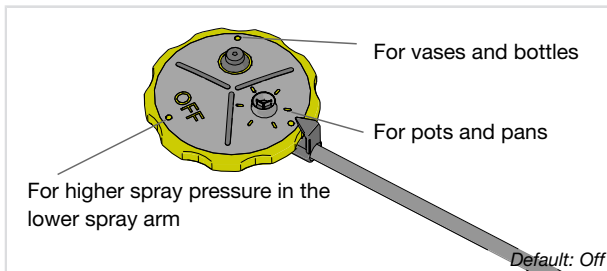

Leave the power zones open if you want an increased water flow where, for example, you have placed pots and pans or vases and bottles. Turn the dishwasher's power zones off if you want greater spray pressure in the lower spray arm.

Washing large plates

You can adjust the lower basket for plates with a diameter of 9 3/4-15 1/3" (25-39 cm) by moving the adjustable plate supports and their fixtures to increase the distance between the tine rows.

Accessory

Buy a wine glass shelf with space for six tall¹⁾ wine glasses. The wine glass shelf is designed to ensure optimal washing and drying results with tall wine glasses. The wine glass shelf is placed in the rear section of the lower basket. This accessory is available where you bought the dishwasher.

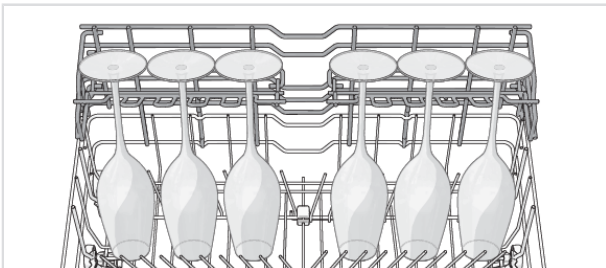

¹⁾ Height: max. 9 7/8" (25 cm), Diameter: max. 2 15/16" (7.5 cm)

Loading the dishwasher

Cutlery basket

Place cutlery with the handles facing down, except for knives, and spread them out as much as possible. Ensure that spoons do not stack inside each other.

The cutlery basket is best placed in the middle at the front of the lower basket to best utilize dishwashing performance from the unique spray zone intended for the cutlery basket.

WARNING!

Knives and other pointed items must be placed horizontally in the dishwasher's special cutlery baskets.

Fold-down section for small items

The cutlery basket has a fold-down section in the middle for small items or small shafts (such as electric whisk attachments).

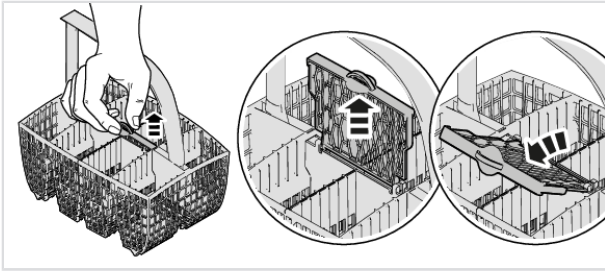

Typical load

Recommended for daily, regular, or typical use.

Upper basket

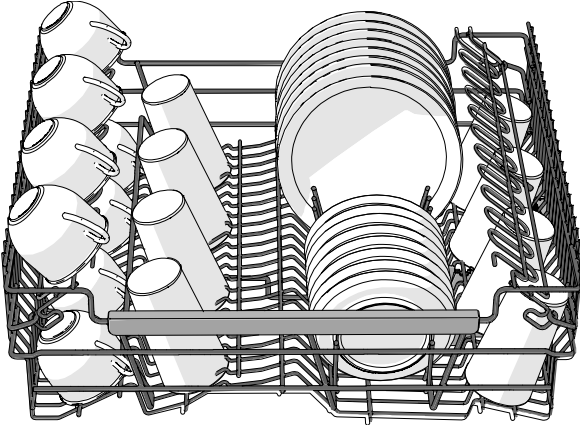

NOTE!

Ensure the upper basket is set to its lowest position.

Lower basket

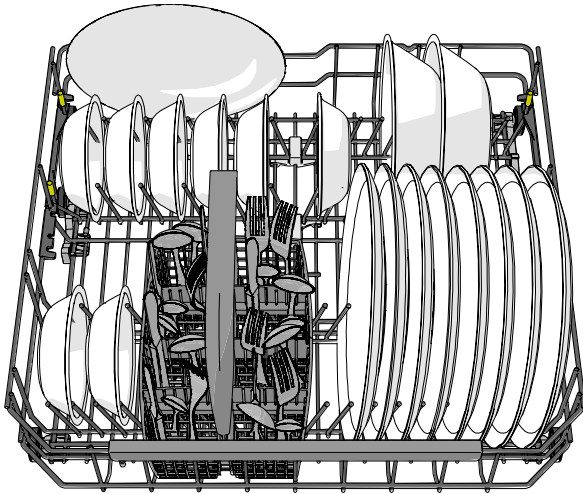

Using the dishwasher

Add detergent

Follow the instructions on the detergent packaging.

Too much detergent can result in less effective dishwashing and lead to greater environmental impact.

Detergent compartment

The detergent compartment must be dry when adding detergent.

If powder or liquid dishwasher detergent is used, add a small amount of the detergent to the compartment for prewash detergent.

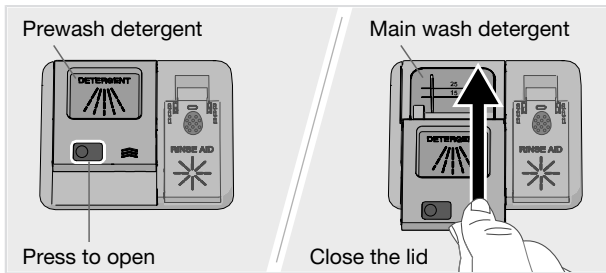

NOTE!

Use only dishwasher detergent. Liquid hand-washing detergent must not be used as the foam that forms prevents the dishwasher from operating effectively.

All-in-one detergent

There are many types of all-in-one detergents on the market. Read through the directions for these products carefully.

Activate the TAB setting when using an all-in-one detergent that contains rinse aid.

Dishwasher tablets are not recommended for short programs (less than 75 minutes). Use powder or liquid dishwasher detergent instead.

NOTE!

Optimal washing and drying results are achieved by using normal dishwasher detergent together with separately dispensed rinse aid.

Contact the detergent manufacturer if you have questions about the detergent.

Using the dishwasher



On/Off

Open the door and press . Also turn on the water supply valve if it is turned off.

PROG Select program

To select a program, press **PROG** until the desired program is shown on the display.

Select a program to suit the type of dishes and how dirty they are.

Normal

This program is recommended for daily, regular, or typical use to completely wash a full load of normally soiled dishes, such as plates, serving dishes, cups, and glasses.

Auto

The dishwasher can measure how dirty the dishes are and adjust water consumption and temperature accordingly. When newly installed, the program needs to be run five times before it is fully adapted and can provide the best results.

Intensive

A program with a high temperature for dissolving grease on heavily soiled dishes, such as pans, casserole dishes, and oven dishes. If these dishes do not completely fill the dishwasher, you can add plates and other dishes.

Quick pro²⁾

A fast and effective program for slightly dried leftovers. (This program is not intended for burnt food, such as on oven dishes.)

The Auto door open option is important for ensuring the best drying results.

²⁾ When combined with Speed, the program is shortened (39 minutes).

Using the dishwasher



Time

The program adapts to the specified running time or finish time. With this program, it is important to choose a time suited to how dirty the dishes are.

Press to set the desired program time.

0:15-0:45	Lightly soiled dishes
1:00-1:30	Normally soiled dishes
2:00-2:30	Heavily soiled dishes



Sanitize

This program is recommended for baby bottles and cutting boards when additional sanitation is required. The temperature is high in the main wash and in the final rinse.



Rinse and hold

Use to rinse dishes while you wait for the dishwasher to become fully loaded.



Self-cleaning

Self-cleaning program for sanitizing the dishwasher tub, spray arms, and spray pipes.

This program should be run (with no dishes in the machine) using regular dishwasher detergent or citric acid. Special dishwasher cleaners are also available in stores. For the removal of limescale deposits, see *Dishwasher tub* in the chapter *Care and maintenance instructions*.

72h

Anti-odor³⁾

This program prevents bad odors from dirty dishes left in the dishwasher. Only the dishwasher's fan is activated (at regular intervals over a period of 72 hours).



Select program mode

Press to scroll through the available program modes. The symbol is dimly lit in available program modes and glows brighter when a program mode has been activated. (The program modes you can select vary between programs.)

▶▶ Speed

The program time is shortened, but the dishwasher uses more energy.



Green

The dishwasher uses less energy and water.



Night



Lower noise level during the dishwashing program. The program time is extended.

Heat boost

The higher temperature dissolves grease on very dirty dishes, but the dishwasher consumes more energy and water. The program time is extended.

³⁾ Activate Odor control in the dishwasher's Settings menu. See the Settings chapter.

Select option

Available options are dimly lit. Select the options ( , ) to activate them. The options glow brighter when activated. (The options you can select vary between programs.)

Auto door open

The dishwasher door opens automatically, which shortens the program time and improves the drying results. Wait until the dishwasher indicates that the program has ended and the dishes have cooled before unloading the dishwasher.

The drying time of the Auto door open option varies (from 5 to 90 minutes) depending on the model, program, and temperature of the final rinse.

The Auto door open option is pre-selected for some programs.

NOTE!



For the best drying results, do not close the door before the drying phase has finished and the machine has automatically switched off.

WARNING!

The dishwasher door must not be blocked or closed when opened automatically. Doing so may damage the door lock mechanism. Wait at least 5 minutes before closing the door.

Delayed start

When you select Delayed start, the dishwasher will start 1-24 hours after you have pressed  and closed the door.

1. Press  once to activate Delayed start. Press several times, or hold it in, to set the desired number of hours.
2. Press  and close the door. The timer counts down and the dishwasher starts after the selected delay.

If you want to cancel the Delayed start option, open the door then press and hold  for three seconds.



Start/Stop

Press  until the display shows "Program started, close door in 4 sec". This indicates that the dishwasher is ready to start. Close the door properly within four seconds, otherwise the dishwasher will not start.

If the dishwasher is not started or the door is not closed within 2 minutes of the last time the control panel was pressed, the machine switches off.

To remote start the dishwasher, see the chapter *WiFi connection*.

Cancel or changing a program

If you want to change the program after starting the dishwasher, open the door then press and hold  for three seconds. Add more detergent if the lid of the detergent dispenser has opened. Then choose a new program, press , and close the door within four seconds.

Using the dishwasher

Time remaining

Once you have chosen a program, program mode, and options, the time the program took when last used is displayed.

Status light

The status light at the bottom on the dishwasher provides information by means of 3 different colors.

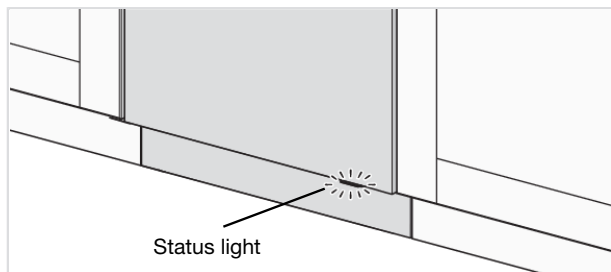

Blue - Load more

The program has started, but you can still load more dishes.

Red - Do not load

You should not load more dishes (can result in poor dishwashing).

A flashing light indicates that the door has been opened while a program is in progress. If it flashes when the door is closed, an error has occurred. See the chapter Troubleshooting.

Green - Unload

The dishwashing program is finished. The status light stays on for 30 minutes.

Flashing blue/green

The status light flashes blue/green to indicate that remote start is activated.

If you want to load more dishes⁴⁾

Open the door. The dishwasher stops automatically. Add the dishes. Press **▶ □** and close the door within four seconds.

If the dishwashing program was remote started, the program will be paused. Press **▶ □** and close the door within four seconds and the interrupted program will continue. You can monitor the dishwasher using the *Connect Life* app and remote stop the program, although you will not be able to remote start it again.

WARNING!

If the door is open, "Program paused" is shown on the display. If you want the dishwashing program to continue, press **▶ □** and close the door immediately. If you want to cancel the dishwashing program, press and hold **▶ □** for three seconds.

⁴⁾ You should not load more dishes if the status light is red.

Power failure

If the dishwasher is turned off due to a power failure when a dishwashing program is running, the program continues when power is restored. If the power is lost during drying, the program is interrupted.

If the dishwashing program was remote started and has not ended, the program will continue once the power is restored. You can monitor the dishwasher using the *Connect Life* app and remote stop the program, although you will not be able to remote start it again.

If you open the door for more than 2 minutes during drying, the program will be interrupted.

Once the program has finished

The end of the program is indicated by one short signal from the buzzer. The chapter *Settings* describes how to change this function.

Moreover, the end of the program is indicated by the status light turning green.

Once the dishwasher door is opened and the program has finished, "Program done" appears on the display.

The dishwasher switches off automatically after the program ends.

To minimize the risk of leaks, we recommend that you turn off the water supply valve if away from home for an extended period of time.

The best drying results

- Fully load the dishwasher.
- Angle dishes with hollows, such as cups, so that the rinse water will run off. This is also important for plastic items.
- Fill up the rinse aid compartment or increase the rinse aid dosage setting.
- Activate the Auto door open option.
- Allow the dishes to cool before unloading the dishwasher.

Unloading the dishwasher

Hot porcelain is more fragile. Leave the dishes to cool in the dishwasher before unloading them.

Unload the lower basket first to avoid any water drops from the upper basket falling onto the dishes in the lower basket.

Program chart

Program	Program mode / Option	Number of prewashes	Main wash	Number of rinses	Final rinse	Consumption values ¹⁾				
						Cold water ²⁾		Hot water ³⁾		Water cons. (gallon)
						Dishwashing time (approx. hrs:min)	Energy (approx. kWh)	Dishwashing time (approx. hrs:min)	Energy (approx. kWh)	
Normal ⁴⁾	5)	1	55 °C 131 °F	2	58 °C 136 °F	2:05	1.0	1:40	0.6	3.0
Auto	5)	2-3	50-65 °C 122-149 °F	2-3	65 °C 149 °F	2:30-3:40	1.0-1.5	2:10-3:10	0.7-1.0	3.7-5.5
Intensive		2	70 °C 158 °F	2	70 °C 158 °F	3:20	1.7	2:50	1.2	4.2
Quick pro	5)		60 °C 140 °F	3	65 °C 149 °F	0:59	0.8	0:59	0.7	3.8
Time		0-2	<65 °C <149 °F	2	<65 °C <149 °F	0:15-2:30	0.2-1.4	0:15-2:30	0.1-0.9	2.6-4.4
Sanitize			70 °C 158 °F	2	70 °C 158 °F	1:20	1.4	1:10	1.0	2.8
Rinse and hold				1		0:07	0.01	0:07	0.01	0.9
Self-cleaning			70 °C 158 °F	2	70 °C 158 °F	1:20	1.3	1:10	0.9	2.6
Anti-odor						72:00	0.2	72:00	0.2	

¹⁾ Consumption values vary depending on the temperature of the incoming water, room temperature, load size, selected additional functions, and more.

²⁾ Connection to cold water, approx. 50 °F (10 °C). (A cold water supply is recommended.)

³⁾ Connection to hot water, approx. 120 °F (50 °C).

⁴⁾ The energy label performance figures are based on this program. Dishwasher connected to cold water, approx. 50 °F (10 °C). This program is recommended for daily, regular or typical use to completely wash a full load of normally soiled dishes, such as plates, serving dishes, cups and glasses.

⁵⁾ Auto door open

Connect Life

You can remote control this dishwasher with your smartphone/tablet. Connect the dishwasher to your wireless network to be able to remote control and start the dishwasher using the *Connect Life* app. The app can be used to find information, change settings, start a program, and monitor the dishwasher. (The dishwasher can always be used without the app.)

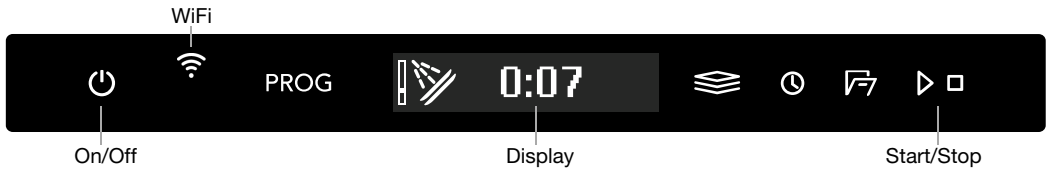

Preparations

- Your smartphone/tablet must be connected to the internet.
- The router in your wireless network must be connected to the internet, and the dishwasher must be in range of your wireless network.
- Use your smartphone/tablet to download the *Connect Life* app from the appropriate app store or scan the QR code below.



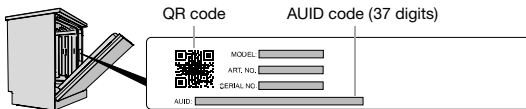

- You will find the dishwasher's QR code (and the AUID code) on the serial number plate.



Connect to a network and pair

Connect the dishwasher to your wireless network and pair with your smartphone/tablet. (This can also be done from the dishwasher's Settings menu.)

- Open the *Connect Life* app and register an account.
- Go to *Appliances*. Click *Add appliances* or the + button. Select *Home appliances*.
- Scan the dishwasher's QR code (see the serial number plate). Follow the further instructions in the app.
- Open the dishwasher door and press .
- On the dishwasher's control panel: Press  to activate the WiFi module.
- On the dishwasher's control panel: Press and hold  for 3 seconds to initiate *Connection setup*.

Network symbol on the display

Flashing 0.5 sec on/off

The dishwasher is ready to be connected to your wireless network or paired with your smartphone/tablet.

WiFi connection

Flashing 1.0 sec on/off
Glows

The dishwasher is connected to your wireless network.
The dishwasher is connected to your wireless network and the cloud.

Remote control the dishwasher

The dishwasher's network symbol  is shown on the display when the dishwasher is paired with a smartphone/tablet. You can use the *Connect Life* app to monitor the dishwasher and change settings.

Remote start the dishwasher

To remote start the dishwasher, press . Remote start activated will appear on the dishwasher's display. Close the door. The status light will flash blue/green to indicate that remote start is activated.

In the *Connect Life* app, select and start a program.



If the door is not closed within 2 minutes, the machine switches off.

NOTE!

The dishwasher can always be used without the app. When the dishwasher's control panel is pressed, commands from the *Connect Life* app are blocked for 10 seconds.



Pair more devices

Pair more devices/users with the dishwasher. (This can also be done from the dishwasher's Settings menu.)

- Open the *Connect Life* app and log in to your account or register a new account.
- Go to *Appliances*. Click *Add appliances* or the + button. Select *Home appliances*.
- Scan the dishwasher's QR code (see the serial number plate). Follow the further instructions in the app.
- Open the dishwasher door and press .
- On the dishwasher's control panel: Press and hold  for 4 seconds to initiate *Add device*.



Turn off existing WiFi / Turn on existing WiFi

After connecting the dishwasher to your local network, you can select *Turn off existing WiFi* to deactivate the connection. Select *Turn on existing WiFi* to reconnect to the same network. (This can also be done from the dishwasher's Settings menu.)

- On the dishwasher's control panel: Press and hold  for 8 seconds to select *Turn off existing WiFi*. Briefly press  to select *Turn on existing WiFi* again.

Remove all devices

Remove all connected devices/users. (This can also be done from the dishwasher's Settings menu.)

- On the dishwasher's control panel: Press and hold  for 4 seconds, then press and hold  for 3 seconds to select *Remove all devices*.

Open the door and press .



To open the dishwasher's Settings menu, press **PROG** until  Settings menu is shown on the display and confirm your selection with .

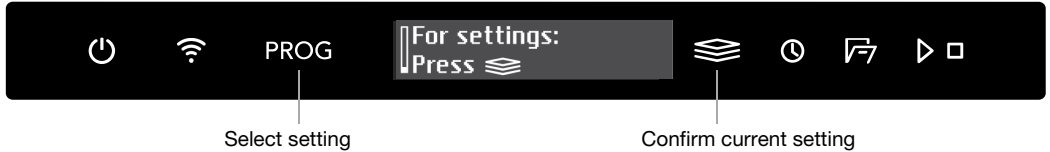



To exit the dishwasher's Settings menu, select Exit and confirm your selection with .

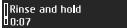

Settings		Alternatives
1.	Language	You can choose the language used for the display.
2.	Network	The current WiFi status is shown on the display.
	WiFi status	Connect the dishwasher to your wireless network to be able to remote control the dishwasher using the <i>Connect Life</i> app. See <i>Preparations</i> in the chapter <i>WiFi connection</i> .
	WiFi connection	<i>Turn off existing WiFi/Turn on existing WiFi</i> After connecting the dishwasher to your local network, you can select <i>Turn off existing WiFi</i> to deactivate the connection. Select <i>Turn on existing WiFi</i> to reconnect to the same network.
	Connection setup	Connect the dishwasher to your wireless network and pair with your smartphone/tablet. <ul style="list-style-type: none"> • Open the <i>Connect Life</i> app and register an account. • Go to <i>Appliances</i>. Click <i>Add appliances</i> or the + button. Select <i>Home appliances</i>. • Scan the dishwasher's QR code (see the serial number plate). Follow the further instructions in the app. • Select <i>Connection setup</i>.
	Add device	Pair more devices/users with the dishwasher. <ul style="list-style-type: none"> • Open the <i>Connect Life</i> app and register an account. • Go to <i>Appliances</i>. Click <i>Add appliances</i> or the + button. Select <i>Home appliances</i>. • Scan the dishwasher's QR code (see the serial number plate). Follow the further instructions in the app. • Select <i>Add device</i> .
	Remove all devices	Select <i>Remove all devices</i> to remove all connected devices/users.
	WiFi factory reset	Select <i>WiFi factory reset</i> to restore the default factory settings.
	Exit	Select <i>Exit</i> and press  to exit the menu for Network.

Settings

Settings	Alternatives	
3. Automatic child lock	<i>On/Off</i>	<p>You can activate the Automatic child lock setting to prevent children from starting the dishwasher.</p> <p>To temporarily deactivate or activate the Automatic child lock setting, press and hold  and  for three seconds.</p>
4. Display	Logotype <i>On/Off</i>	Setting to hide the logo shown on the display.
	Contrast <i>1/2/3/4</i>	For adjusting the contrast of the display.
	Program Info screen <i>T/S</i>	<p>You can select which information is shown on the display.</p> <p> T-Text (Text)</p> <p> S-Symbol (Symbol)</p>
5. Sound	Feedback <i>0/1/2/3</i>	A beep confirms that the control panel has been pressed.
	Notification <i>0/1/2/3</i>	<p>The buzzer indicates when a dishwashing program has ended.</p> <p><i>Error messages are always indicated by a loud buzzer.</i></p>
6. Rinse aid	<i>0/1/2/3/4/5</i>	<p>Setting for rinse aid dosage. The rinse aid dispenser can be adjusted between 0 (Off) and 5 (High dosage).</p> <p>Increase the rinse aid dosage:</p> <ul style="list-style-type: none"> • If the dishes have water marks. <p>Reduce the rinse aid dosage:</p> <ul style="list-style-type: none"> • If the dishes have a sticky white/blue film. • If the dishes are streaked. • Heavy foaming. If you have very soft water, the rinse aid can be diluted 50:50 with water.
7. TAB	<i>On/Off</i>	<p>Activate this setting when using an all-in-one detergent that contains rinse aid.</p> <p>This setting reduces the rinse aid dosage.</p>

Settings	Alternatives	
8. Super rinse	<i>On/Off</i>	<p>The Super rinse function rinses the dishes an extra two times.</p> <p>The program time is extended and the dishwasher uses more energy and water.</p> <p><i>Activated in the following programs:</i></p> <p><i>Normal</i></p> <p><i>Intensive</i></p> <p><i>Quick pro</i></p> <p><i>Sanitize</i></p>
9. Interior light at power off	<i>On/Off</i>	<p>Select whether the interior light is to be switched on when the dishwasher is turned off and the door is opened. (If  is turned on, the interior light is always switched on when the door is opened.)</p>
10. Odor control	<i>On/Off</i>	<p>When Odor control is activated,  ^{72h} Anti-odor can be selected from the program table.</p>
11. Failure readout		<p>Any error messages.</p> <p><i>When contacting your Customer Care Center, you may be asked to provide the most recent error messages.</i></p>
12. Factory reset		<p>Restores all settings to the factory defaults. Select Factory reset and press  .</p>
13. Exit		<p>To exit the dishwasher's Settings menu, select Exit and press .</p>

Care and maintenance instructions

* Add rinse aid

When the rinse aid needs filling up, the above symbol lights on the display.

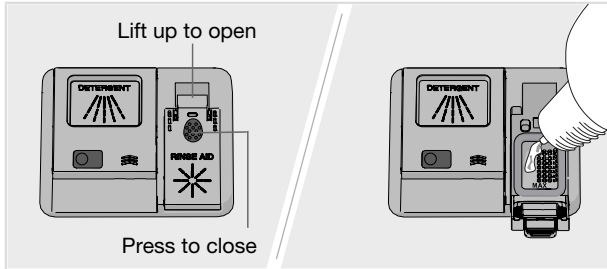

1. Open the rinse aid compartment lid.
2. Carefully fill up with rinse aid to the level marked **MAX**.
3. Wipe up any spilled rinse aid around the compartment.
4. Close the lid firmly.

After filling up, it may take a while before the symbol goes out.

Clean the filters

Coarse filter

The coarse filter traps larger food particles, which cannot get past the drain pump. Empty the coarse filter when necessary. It should be cleaned at regular intervals depending on how often the dishwasher is used.

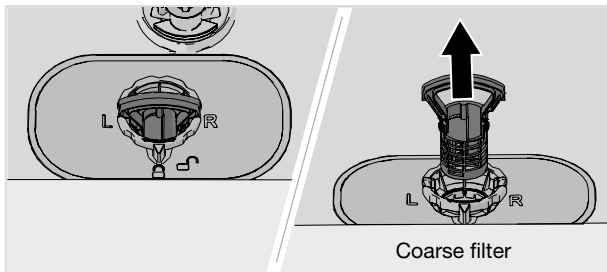

1. Lift the coarse filter by the handle.
2. Empty the coarse filter.
3. Refit the coarse filter. Press it down until it clicks into place.

Fine filter

Debris that collects on the fine filter is automatically rinsed away during each wash. Clean the fine filter when necessary. It should be cleaned at regular intervals depending on how often the dishwasher is used.

Care and maintenance instructions

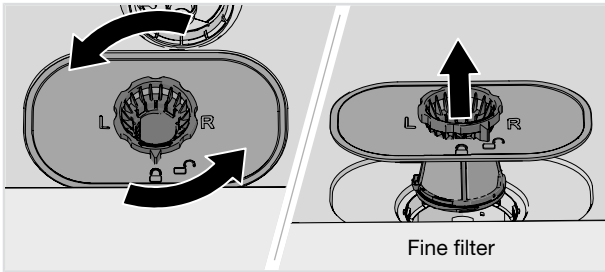

1. Turn the lock ring counterclockwise and lift the fine filter straight up.
2. Clean the fine filter.
3. Refit the fine filter and turn the lock ring clockwise to its stop position. Check that the edges seal properly.

Remember to refit the coarse filter!

NOTE!

Dishwashing results may be affected if the coarse and fine filters are incorrectly fitted. The dishwasher must not be used without the filters in place!

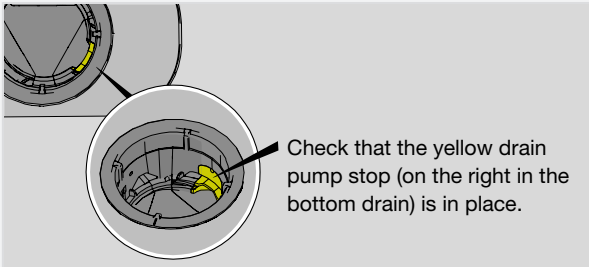

Cleaning the spray arms

Holes and bearings can become blocked. Remove debris using a needle or similar item. The spray arms have holes on the bottom.

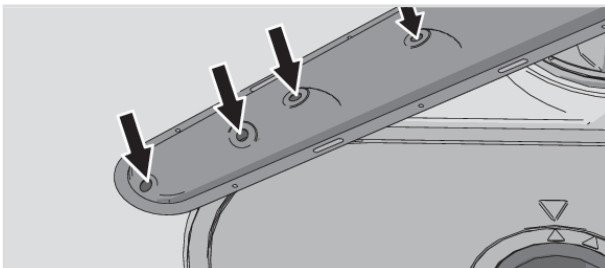

Spray arms can be removed for cleaning. Remember to put them firmly back into place afterward.

Care and maintenance instructions

Top spray arm

- Pull out the top cutlery tray. Push up on the top spray arm while turning it counterclockwise to release it.

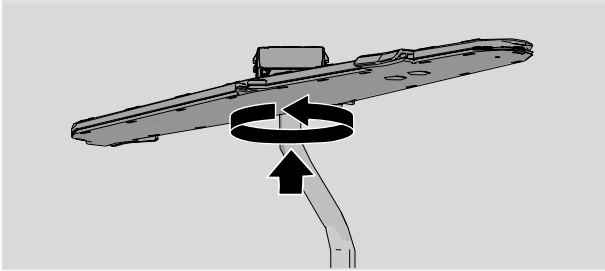

Upper spray arm

- Pull out the upper basket.
- Unscrew the spray arm bearings counterclockwise to remove the spray arm from the upper basket.

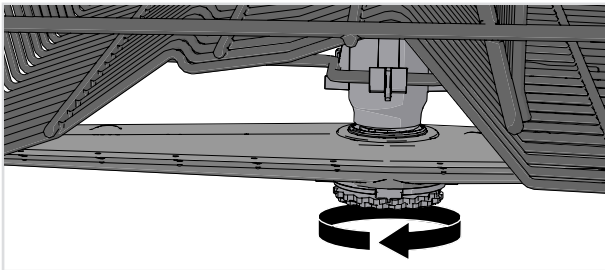

Lower spray arm

- Pull the lower spray arm straight up to release it.

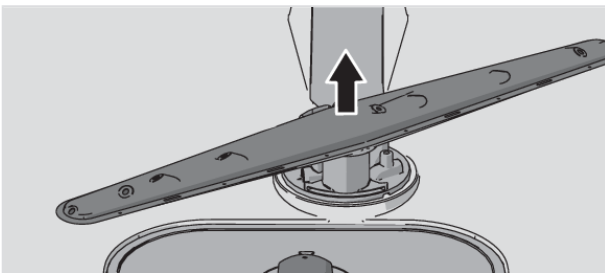

Clean the outside of the dishwasher

Door and door seal

Open the door. Clean the sides of the door and the door seal regularly with a slightly damp cloth. Clean the door seal at the lower front edge of the dishwasher with a cleaning brush.

Care and maintenance instructions

Control panel

Keep the control panel clean. If necessary, wipe it with a dry or slightly damp cloth. Never use cleaning products – they may scratch the surface.

Run Self-cleaning

Dishwasher tub

The dishwasher tub is made of stainless steel and is kept clean through normal use (when used regularly).

If you have hard water, limescale deposits may build up in the dishwasher. If this happens, run the Self-cleaning program with two tablespoons of citric acid in the detergent compartment (with no dishes in the machine). Special dishwasher cleaners are also available in stores.

Never use anti-freeze, Draino®, CLR®, or other chemical cleaners.

Remove blockages

Unblocking the drain pump

If the dishwasher still contains water after the program has finished, something may be blocking the drain pump, which results in the error message Water outlet fault or BLDC drain pump fault.

1. Turn off the machine using  and remove the plug from the power outlet.
2. Remove the coarse filter and the fine filter.
3. Scoop out the water from the dishwasher tub.
4. In order to inspect the drain pump, remove the yellow drain pump stop on the right in the bottom drain. (Use a pair of pliers if necessary.)
5. Turn the pump wheel located behind the drain pump stop by hand. Carefully remove any sharp items, such as glass.
6. Reinstall the drain pump stop along with the fine and coarse filters.
7. Plug the machine in again.

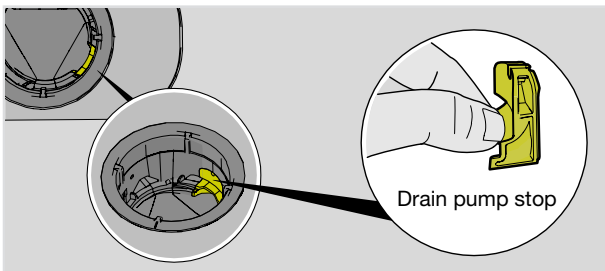

NOTE!

Do not forget to reinstall the drain pump stop.

Troubleshooting

Error messages		Action
F10	Overfilling water 1	Unblocking the drain pump. See the chapter <i>Care and maintenance instructions</i> . If the problem persists, contact your nearest Customer Care Center.
F11	Water outlet fault	See "Water remains in the dishwasher above the filters" under "Problem" in the table below. If the problem persists, contact your nearest Customer Care Center.
F12	Water inlet fault 1	Check that the water supply valve is on. If the problem persists, contact your nearest Customer Care Center. The water pressure should be 4.2-140 psi.
F40	Inlet valve leakage	Turn off the water supply valve and contact your nearest Customer Care Center.
F41	Heater fault 1	Turn off the water supply valve. Remove the plug from the power outlet and contact your nearest Customer Care Center.
F45	Diverter fault	Contact your nearest Customer Care Center.
F52	Water level fault	Clean the coarse and fine filters. If the problem persists, contact your nearest Customer Care Center.
F54	Overfilling water 2	Turn off the water supply valve and contact your nearest Customer Care Center. To avoid water leakage outside the dishwasher, do not remove the plug from the power outlet until the water supply valve has been turned off!
F56	Circulation pump fault	Contact your nearest Customer Care Center.
F67	Water inlet fault 2	Check that the water supply valve is on. If the problem persists, contact your nearest Customer Care Center. The water pressure should be 4.2-140 psi.
F68	BLDC drain pump fault	See "Water remains in the dishwasher above the filters" under "Problem" in the table below. If the problem persists, contact your nearest Customer Care Center.

Press any button to clear the error message.

General

Problem	Possible causes	Action
The control panel does not react when pressed.	You have pressed the control panel too soon after opening the door.	Wait a moment then try again.
	Child lock or Automatic child lock is activated.	See the chapter <i>Important safety instructions</i> .
	The door is closed.	Open the door. The control panel only reacts to use when the door is open.
	Dirt on the control panel.	Clean with a dry or slightly damp cloth.
Cannot close door.	The baskets are not correctly positioned.	Check that the baskets are correctly positioned horizontally.
		Check that the dishes are not blocking the baskets from sliding properly into place.
	The door lock does not click into place and lock.	<p>Check the door lock. If it does not click into place and lock, open the door.</p> <p>Press and hold PROG and F7 until the display starts flashing. Wait until it stops flashing (60 seconds). Close the door. Check that the door lock clicks into place and locks.</p>

Troubleshooting

Problem	Possible causes	Action
The dishwasher does not start.	▶ □ has not been pressed.	Press ▶ □ until the display shows "Program started, close door in 4 sec".
	The door is not closed properly or was not closed immediately after you pressed ▶ □ .	Close the door within four seconds, otherwise the dishwasher will not start.
	You have opened the dishwasher to add more dishes while a program is in progress.	If you want the dishwashing program to continue, press ▶ □ and close the door within four seconds.
	The door lock has not clicked into place and locked.	Check the door lock. If it has not clicked into place and locked, open the door. Press and hold PROG and  until the display starts flashing. Wait until it stops flashing (60 seconds). Close the door. Check that the door lock clicks into place and locks and that the dishwasher starts.
	Check whether the Delayed start option has been selected.	Press and hold ▶ □ for three seconds if you want to cancel the Delayed start option.
	The plug is not plugged into the power outlet.	Check.
	A fuse/circuit breaker has been tripped.	Check.

Problem	Possible causes	Action
The dishes are not clean.	The spray arms do not rotate.	Check that the dishes are not blocking the spray arms.
	Spray arm holes or bearings blocked.	Clean the spray arms. See the chapter <i>Care and maintenance instructions</i> .
	Unsuitable dishwashing program.	Select a program with a high temperature to dissolve grease on heavily soiled dishes, such as Intensive.
	Incorrect detergent dosage.	Dose according to water hardness. Far too much or far too little detergent can result in poor dishwashing results.
	Detergent is too old. Detergent is a perishable product.	Avoid large packages.
	Dishes loaded incorrectly.	Do not cover porcelain with large bowls or the like. Avoid placing very tall glasses in the corners of the baskets. See the chapter <i>Loading the dishwasher</i> .
	Glasses and cups have toppled over during the program.	Load the dishes securely.
	The filters are clogged.	Clean the coarse and fine filters.
	The filters are not fitted correctly.	Check that the filters are fitted correctly. See the chapter <i>Care and maintenance instructions</i> .
	Drain pump stop missing.	Check that the yellow drain pump stop (on the right in the bottom drain) is in place. See the chapter <i>Care and maintenance instructions</i> .
Spots on stainless steel or silver.	Some types of food, such as mustard, mayonnaise, lemon, vinegar, salt, and dressings, can cause spots on stainless steel if left for too long.	Rinse off these types of food if not starting the dishwasher immediately. Use the Rinse and hold program.
	All stainless steel can cause spots on silver if they come into contact during dishwashing. Aluminum can also cause spots on dishes.	In order to avoid marks and tarnishing, separate dishes made from different metals, such as silver, stainless steel, and aluminum.

Troubleshooting

Problem	Possible causes	Action
Spots or films on the dishes.	Incorrect rinse aid dosage setting.	See the chapter <i>Settings</i> .
	The TAB setting is activated and all-in-one detergent with insufficient drying effect is being used.	Switch all-in-one detergents or deactivate the TAB setting and fill up with separate rinse aid. See Rinse aid in the chapter <i>Settings</i> .
	Too high temperature and/or too much detergent can cause etching on crystal. Unfortunately, this cannot be repaired, only prevented.	Wash crystal at a low temperature and with a conservative amount of detergent. Contact the detergent manufacturer.
The dishes have a sticky white/blue film.	Rinse aid dosage setting too high.	Reduce the dosage. See the chapter <i>Settings</i> . If you have very soft water, you may want to dilute the rinse aid 50:50 with water.
Spots left after washing.	Lipstick and tea/coffee stains can be difficult to remove.	Use a detergent with a bleaching agent.
Detergent residue in the detergent compartment after dishwashing.	The detergent compartment was damp when adding detergent.	The detergent compartment must be dry when adding detergent.
	The detergent compartment has been blocked.	Check that the dishes are not preventing the detergent compartment from opening.
Rattling sound when dishwashing.	The dishes are not correctly placed or the spray arms are not rotating.	Check that the dishes are placed securely. Spin the spray arms to make sure they can rotate.
"Program paused" is shown on the display.	The dishwasher door has been opened while a program is in progress.	If you want the dishwashing program to continue, press ▶ □ and close the door within four seconds. If you want to cancel the dishwashing program, press and hold ▶ □ for three seconds.

Problem	Possible causes	Action
Water remains in the dishwasher above the filters.	The filters are clogged.	Clean the coarse and fine filters.
	The filters are not fitted correctly.	Check that the filters are fitted correctly. See the chapter <i>Care and maintenance instructions</i> .
	Debris in the drain pump.	Clean the drain pump. See the chapter <i>Care and maintenance instructions</i> .
	Drain pump stop missing.	Check that the yellow drain pump stop (on the right in the bottom drain) is in place. See the chapter <i>Care and maintenance instructions</i> .
	Kink in drain hose.	Check that the hose is free from kinks and sharp bends.
	Blocked drain hose.	Loosen the drain hose from where it terminates. Check that no debris has clogged the hose. Is the cone-shaped part of the drain boot cut to the maximum size of the fitting where it attaches?
Bad odor in dishwasher.	Dirt around the seals and in corners.	Clean with dish brush and low foaming cleaner.
	Low temperature programs have been selected for a prolonged period.	Run a program with a high temperature once or twice a month. Or run a self-cleaning program. See Self-cleaning in the chapter <i>Using the dishwasher</i> .
	The dishwasher is connected to a garbage disposer.	Cleaning the garbage disposer connected to the dishwasher can eliminate odors. Follow the disposer manufacturer's cleaning instructions.
Grease deposits in the dishwasher.	Low temperature programs have been selected for a prolonged period.	Select a program with a high temperature to dissolve grease on heavily soiled dishes, such as Intensive. Or run a self-cleaning program once or twice a month. See Self-cleaning in the chapter <i>Using the dishwasher</i> .

Troubleshooting

Problem	Possible causes	Action
The dishes are not dry enough.	The Auto door open option is not activated.	Activate the Auto door open option.
	The dishwasher is not fully loaded.	Fully load the dishwasher.
	Rinse aid needs filling up or dosage is set too low.	Fill up the rinse aid compartment or increase the rinse aid dosage setting.
	The TAB setting is activated and all-in-one detergent with insufficient drying effect is being used.	Switch all-in-one detergents or deactivate the TAB setting and fill up with separate rinse aid. See Rinse aid in the chapter <i>Settings</i> .

WiFi

Problem	Possible causes	Action
The dishwasher's network symbol  does not appear on the display.	The dishwasher is not connected to your wireless network.	Connect the dishwasher to your wireless network. See the chapter <i>WiFi connection</i> .
	WiFi connection is deactivated.	Activate WiFi connection. See <i>Turn off existing WiFi / Turn on existing WiFi</i> in the chapter <i>WiFi connection</i> .
Connection setup Failed	The dishwasher cannot access your wireless network. Or the router is not connected to the internet.	Check that the router is connected to the internet.
		Make sure your wireless network is using 2.4 GHz and is visible. Try moving the router closer to the dishwasher if the signal is too weak.
		See also troubleshooting at www.connectlife.io . If the problem persists, contact your nearest Customer Care Center.
Add device Failed	Your smartphone/tablet is not connected to your wireless network. Or the router is not connected to the internet.	Check that the router is connected to the internet.
		Check that your smartphone/tablet is connected to your wireless network.
		See also troubleshooting at www.connectlife.io . If the problem persists, contact your nearest Customer Care Center.
The dishwasher is shown as disconnected in the <i>Connect Life app</i> .	WiFi connection is deactivated.	Activate WiFi connection. See <i>Turn off existing WiFi / Turn on existing WiFi</i> in the chapter <i>WiFi connection</i> .
		See also troubleshooting at www.connectlife.io . If the problem persists, contact your nearest Customer Care Center.

Troubleshooting

Problem	Possible causes	Action
Software update failed.	The network connection was lost or the dishwasher lost power due to a power failure.	Make sure that the power supply is not interrupted and that the network connection is stable before trying again. If the problem persists, contact your nearest Customer Care Center.

Installation instructions

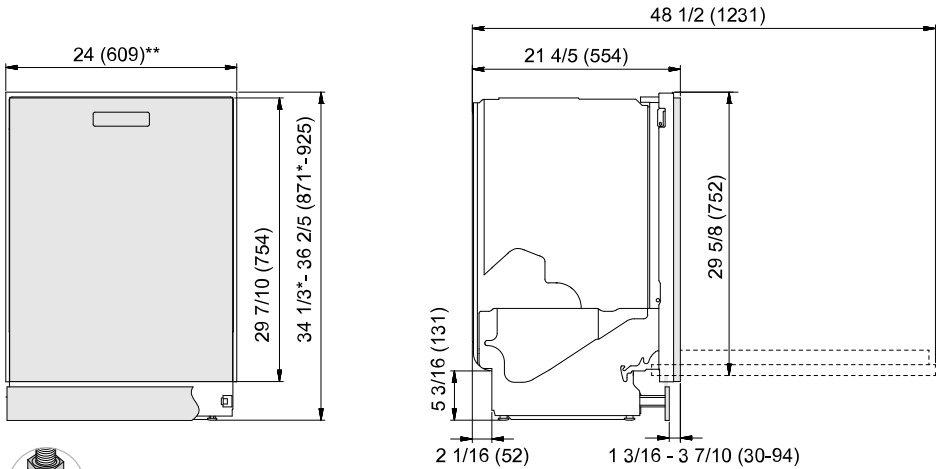

*Remove lock nuts for an installed height of 34 1/3" (871 mm).

**If European widths of 23 5/8" (600 mm) is required, remove the trim kit.

Inches (mm)
Nominal dimensions. Actual measurements may vary.

Important safety instructions

- Connections to electricity, water, and drainage must be performed by a qualified professional.
- Always follow applicable regulations for water, drainage, and electricity.
- Take care during installation! Wear protective gloves! There must always be two people!
- Place a drip tray on the floor beneath the dishwasher to prevent damage from any water leaks.
- Before screwing the dishwasher into place, test the dishwasher by running the Rinse and hold program. Check that the dishwasher fills with water and drains. Also check that none of the connections leak.

WARNING!

The ventilation opening in the lower part of the door must not be blocked by a rug, carpet, or similar furnishing.

WARNING!

Turn off the water supply when installing the dishwasher!

The plug must be disconnected or power to the outlet turned off while installing the dishwasher!

Installation instructions

Transport protection for the door

Do not forget to remove the transport protection for the door when unpacking the dishwasher.

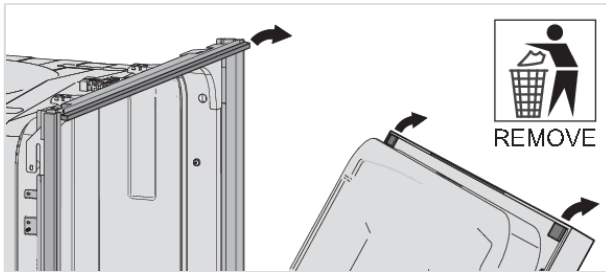

Trim kit

The dishwasher is equipped with a trim kit to fit the 24" (609 mm) cutout standard. If a European width of 23 5/8" (600 mm) is required, remove the trim kit.

Adjust the trim kit

The trim kit can be adjusted backward to level the dishwasher tub.

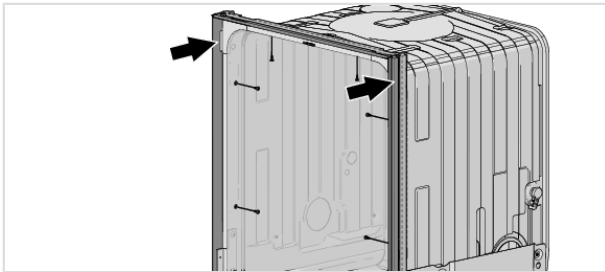

Placing the dishwasher

The dishwasher is intended to be built in under a countertop. The built-in measurements are shown in the illustration. Make sure that the cord and hose hole's edges are even and will not damage the drain and inlet hoses or the power cord.

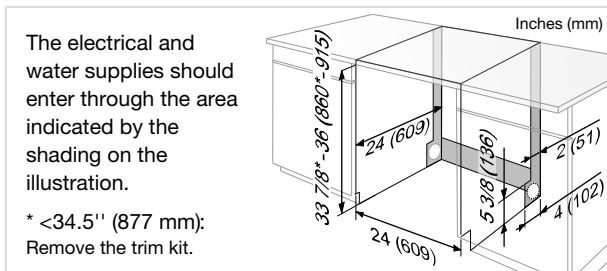

NOTE!

Framed cabinets require additional finished filler material behind the face frame for a proper installation. A minimum 3½" (89 mm) finished return is required on all sides of the opening.

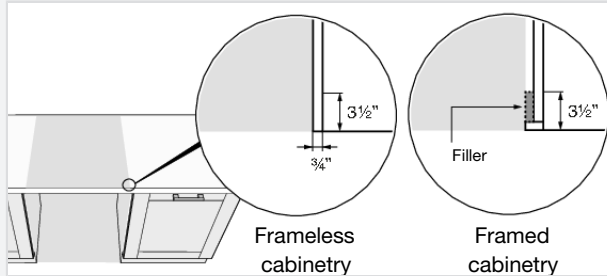

If the dishwasher is built-in, the surrounding furnishings must be resistant to any condensation from the dishwasher.

Accessory

Buy an accessory kit for freestanding installation (two side panels, a countertop, and two anti-tip brackets). If the dishwasher is placed so that one of the sides is visible, side panels must be fitted. If the dishwasher is completely freestanding, both side panels, a countertop, and anti-tip brackets must be fitted. Accessories can be purchased from where you bought the dishwasher.

Fit the protective film

Mount the protective film beneath the countertop and up around the edge. The function of the protective film is to protect the countertop from moisture. (The protective film is in the enclosed plastic bag.)

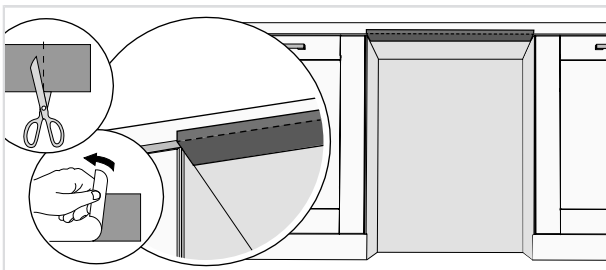

NOTE!

The surface to which the protective film is fitted must be clean and dry.

Adjust the height and slide the dishwasher into place

1. Start by measuring the height from the floor to the bottom edge of the countertop.
2. Measure the height from the floor to the top edge of the dishwasher.

Installation instructions

3. Lean the dishwasher forward a little and adjust the rear foot with the screw at the front of the dishwasher. Turn clockwise to lower or counterclockwise to raise.

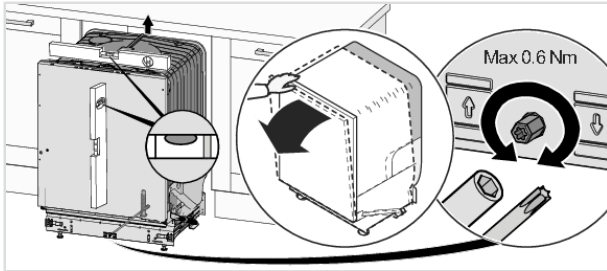

4. Adjust the front feet by turning them clockwise to raise and counterclockwise to lower the dishwasher.

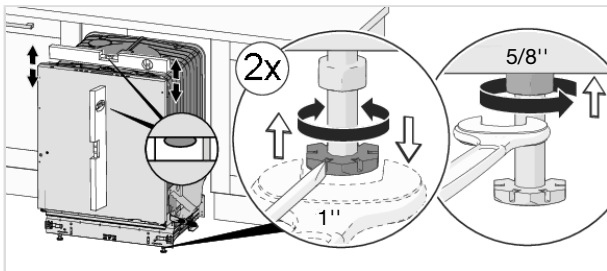

5. Verify there is an air gap of at least 1/8" between the underside of the countertop and the top edge of the dishwasher.

6. Slide the dishwasher into place.

- Pull the supply and drain hoses and the power cord when sliding the dishwasher into place.
- Check that the drain hose has no kinks or sharp bends. Also check that there is nothing that can damage the hoses.

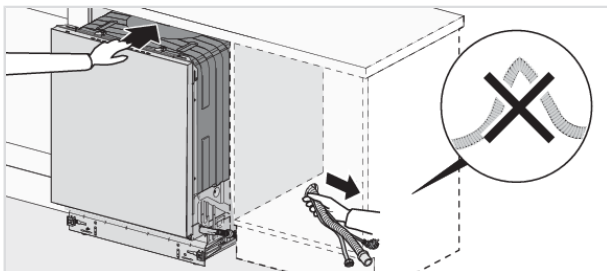

- Check that the machine is installed such that the door opens freely, otherwise door lock functionality may be disrupted.

7. Make any final adjustments to the feet and tighten the lock nuts on the front feet.

Drain connection

This dishwasher is suitable for installing in a raised recess (to obtain an ergonomic working height). This means that the dishwasher can be placed so that the drain hose runs to a lower level than the bottom of the dishwasher, such as by routing it directly to a floor drain.

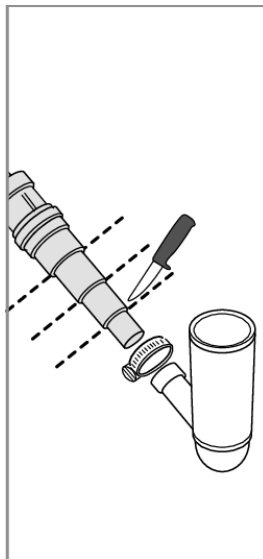
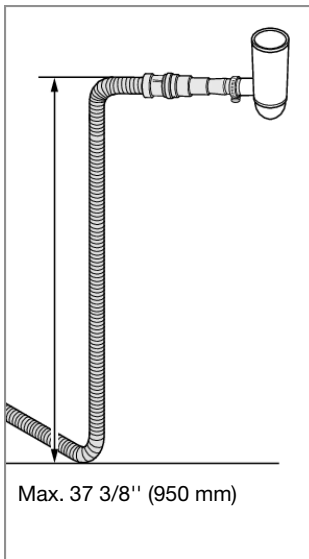
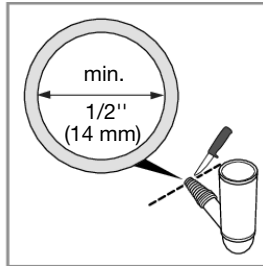
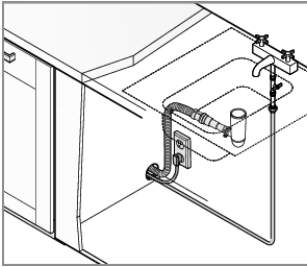

The drain hose can also be connected to a connection nipple on the sink unit's water trap. The connection nipple must have an internal diameter of at least 1/2" (14 mm).

The drain hose may be extended by a maximum of 87" (2.2 m) (the total length of the drain hose must not exceed 177" (4.5 m)). Any joints and connecting pipes must have an internal diameter of at least 1/2" (14 mm). However, the drain hose should ideally be replaced with a new hose without joints.

No part of the drain hose may be more than 37 3/8" (950 mm) above the bottom of the dishwasher.

Attach the drain hose with a hose clamp. Ensure that the drain hose has no kinks.

Installation instructions

Connection to water supply

Use only the inlet hose supplied with the dishwasher. Do not re-use old or other spare hoses.

The supply pipe must be fitted with a water supply valve. The water supply valve must be easily accessible, so that the water can be shut off if the dishwasher has to be moved.

Once the installation is complete, turn on the water supply valve and allow the pressure to settle for a while. Check that all connections are watertight.

Water supply

The machine can be connected to either a cold or a hot (max. 160 °F (70 °C)) water supply. The water pressure should be 4.2-140 psi (0.03-1.0 MPa).

Connect to cold water

Connect the dishwasher to the cold water supply if the building is heated using oil, electricity, or gas.

Connect to hot water

Connect the dishwasher to the hot water supply (max. 160 °F (70 °C)) if the building is heated using an energy-efficient means such as district heating, solar power, or geothermal power. Choosing a hot water connection reduces the dishwasher's energy consumption.

NOTE!

Do not exceed the permitted water supply temperature. Certain materials used in some cookware cannot withstand high temperatures. See *Fragile dishes* in the chapter *Loading the dishwasher*.

Electrical connection

Information about the electrical connection can be found on the serial number plate. This specification must match the electricity supply.

The power outlet for the appliance shall be installed in a cabinet or on a wall adjacent to the undercounter space in which the appliance is to be installed. Do not use an extension cord for this appliance.

The access hole for the electrical supply must be round and smooth and no bigger than 1 1/2" (38 mm) in diameter. If the partition is metal, it needs to be covered with an edge protector.

Use caution when the appliance is installed or removed to reduce the likelihood of damage to the power cord.

Grounding instructions

This appliance must be grounded. In the event of a malfunction or breakdown, grounding will reduce the risk of electric shock by providing a path of least resistance for electric current. This appliance is equipped with a power cord fitted with an equipment grounding conductor and a grounding plug. The plug must be plugged into an appropriate power outlet that is installed and grounded in accordance with all local codes and ordinances.

WARNING!

Improper connection of the equipment grounding conductor can result in a risk of electric shock. Check with a qualified electrician or service representative if you are in doubt as to whether the appliance is properly grounded. Do not modify the plug provided with the appliance. If it does not fit the power outlet, have an appropriate power outlet installed by a qualified electrician.

Screwing the dishwasher into place

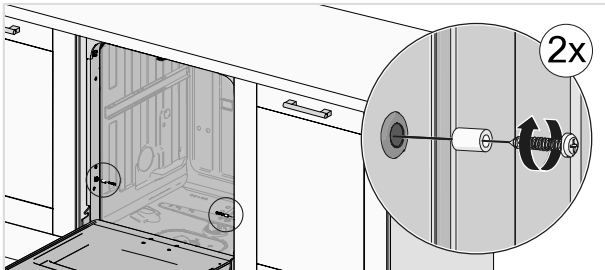
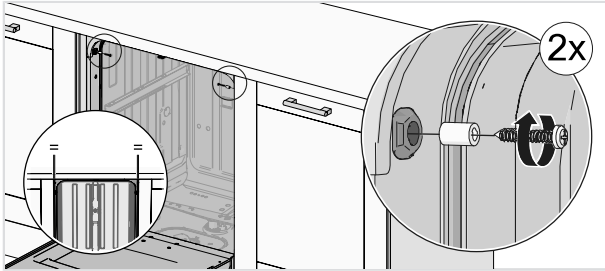

After fastening the machine, check that the front feet still touch the floor.

Screw into the countertop

Alternatively, the dishwasher can be screwed into the underside of the countertop.

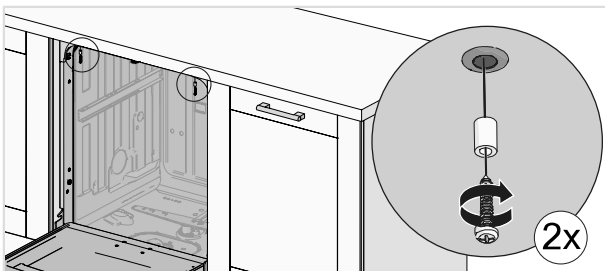

Installation instructions

Dishwasher toe kick

The dishwasher is supplied with a toe kick.

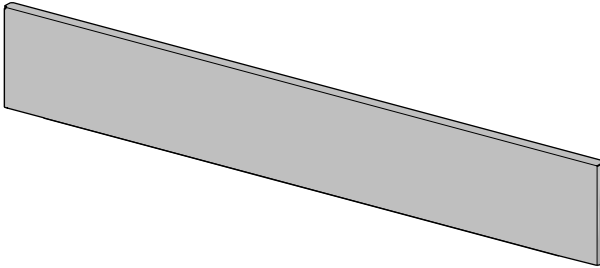

Fit the sound insulation

(only certain models)

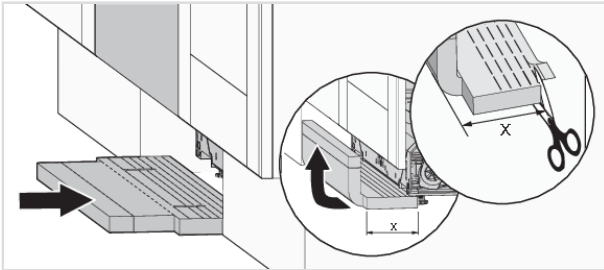
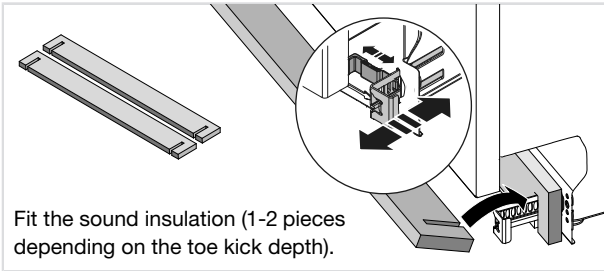

Fit the toe kick

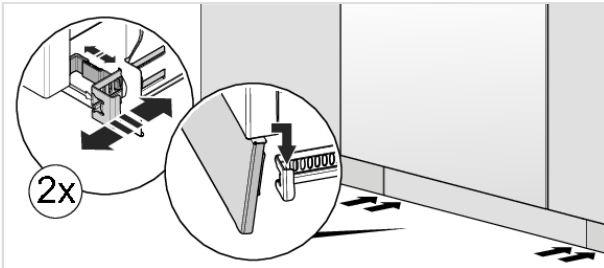

Limited Warranty – Residential Appliances

This Limited Warranty covers parts and labor, except as set forth in this Limited Warranty. Service must be provided by an authorized ASKO service company. YOUR SOLE AND EXCLUSIVE REMEDY UNDER THIS LIMITED WARRANTY SHALL BE PRODUCT REPAIR AS PROVIDED HEREIN. This Limited Warranty is valid only when the ASKO Product is used in the country in which it was purchased. Proof of original purchase date is required to obtain service under this Limited Warranty.

Residential ASKO Products Used Exclusively for Household/Personal Purposes:

Two (2) Years limited Warranty – Any warranty service claims for residential ASKO Products must be filed with ASKO within two (2) years from date of purchase. Service will be provided during normal business hours.

Residential ASKO Products Not Used Exclusively for Household/Personal Purposes or used Commercially or used in Marine, Mobile or Aeronautical Applications:

One (1) Year limited Warranty – Any warranty service claims for ASKO Products not used exclusively for household and personal use, or used commercially or used in marine, mobile, or aeronautical applications must be filed with ASKO within one (1) year from date of purchase. Service will be provided during normal business hours.

Items excluded from warranty

This limited warranty does not cover:

1. Replacement parts or repair labor if the ASKO Product is used in a manner that is inconsistent with published user or operator instructions and/or installation instructions.
2. Service calls to correct the installation of the ASKO Product, to instruct you on how to use the ASKO Product, to replace or repair house fuses, or to correct house wiring or plumbing.
3. Consumable items and parts, such as filters.
4. Damage resulting from accident, alteration, misuse, abuse, negligence, fire, flood, natural disasters, improper use, improper installation, installation not in accordance with electrical or plumbing codes, or use of products not approved by ASKO, as well as any attempted repair by other than authorized ASKO service companies.
5. Cosmetic damage, including scratches, dents, chips or other damage to the finish of the ASKO Product, unless such damage results from defects in materials or workmanship and is reported to ASKO within 5 days from date of purchase.
6. Pickup and delivery. The ASKO Product is intended to be repaired in your home.
7. Repairs to parts or systems resulting from unauthorized modifications made to the ASKO Product.
8. Expenses for travel and transportation for product service if the ASKO Product is located in a remote area where service by an authorized ASKO service company is not available.
9. The removal and reinstallation of the ASKO Product if it is installed in an inaccessible location or is not installed in accordance with ASKO's published installation instructions.
10. Replacement parts or repair labor on ASKO Products with original model/serial numbers that have been removed, altered or cannot be easily determined.

Disclaimer

YOUR SOLE AND EXCLUSIVE REMEDY UNDER THIS LIMITED WARRANTY SHALL BE PRODUCT REPAIR AS PROVIDED HEREIN. EXPRESSLY DISCLAIMED ARE ALL OTHER EXPRESS AND IMPLIED WARRANTIES, INCLUDING ANY IMPLIED WARRANTIES OF MERCHANTABILITY AND FITNESS FOR A PARTICULAR PURPOSE. Some jurisdictions do not allow exclusion or limitations regarding warranty rights. This Limited Warranty gives you specific legal rights and you may have other rights

Service and warranty

that vary from jurisdiction to jurisdiction. Attempted repair by any person other than an authorized ASKO service company will void this Limited Warranty.

Limitation of liability

IN NO EVENT SHALL ASKO OR THE MANUFACTURER AND THEIR RESPECTIVE PARENTS, SUBSIDIARIES AND AFFILIATES BE LIABLE FOR CONSEQUENTIAL, INCIDENTAL, EXEMPLARY, PUNITIVE OR SPECIAL DAMAGES. IN NO EVENT SHALL ASKO OR THE MANUFACTURER AND THEIR RESPECTIVE PARENTS, SUBSIDIARIES AND AFFILIATES BE LIABLE FOR DAMAGES OTHER THAN ACTUAL DAMAGES AND IN NO EVENT FOR DAMAGES IN EXCESS OF THE PRICE PAID FOR THE ASKO PRODUCT AS TO WHICH A CLAIM IS MADE. Some jurisdictions do not allow the exclusion or limitation of incidental, consequential or other damages, so these limitations and exclusions may not apply to you. This Limited Warranty gives you specific legal rights. You also may have other rights that vary from jurisdiction to jurisdiction.

ASKO Customer Care

Read the chapter *Troubleshooting* before contacting the Customer Care Center. If you have encountered a problem that you cannot resolve, please contact your nearest dealer.

USA	us.asko.com, +1-800-898-1879
CANADA	ca.asko.com, +1-800-561-7265, service@distinctive-online.com
MEXICO	asko.com/mx, +52-800-400-4372, atencionalcliente@sub-zeromx.com

When making contact, provide the details on the serial number plate. Include the model name (1), the article number (2), and the serial number (3).

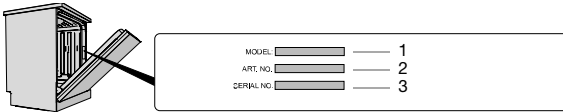

Service after expiration of limited warranty

For information about obtaining parts and labor after expiration of this Limited Warranty or arising outside the scope of this Limited Warranty, please contact ASKO Customer Care.

To verify the ASKO warranty – please visit our local web page.

Number of cycles

Press and hold **PROG** and  for 3 seconds to show Number of cycles on the display.

Technical data

Height:	34 1/3 - 36 2/5" (871-925 mm)
Width:	24" (609 mm) ¹⁾
Depth:	21 4/5" (554 mm)
Weight:	110 lb (50 kg) ²⁾
Water pressure:	4.2-140 psi (0.03-1.0 MPa)
Electrical connection:	See serial number plate
Rated power:	See serial number plate

¹⁾ If European widths of 23 5/8" (600 mm) is required, remove the trim kit.

²⁾ Weight can vary due to different specifications.

ASKO

Inspired by Scandinavia

US.ASKO.COM • CA.ASKO.COM • ASKO.COM/MX



875097-a5

We reserve the right to make changes.