

Shelves - Utility Hook & Mop Strip w/ Drying Rod (3 Hooks - 4 Holders) 36"

Custodial Accessories

MasterFormat Section 10 28 13

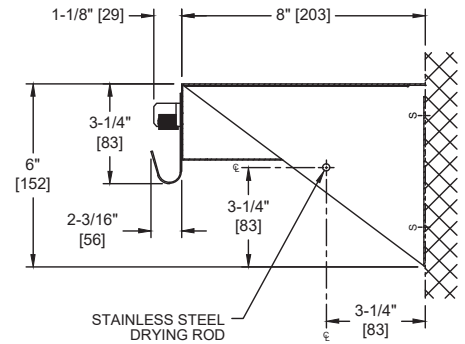
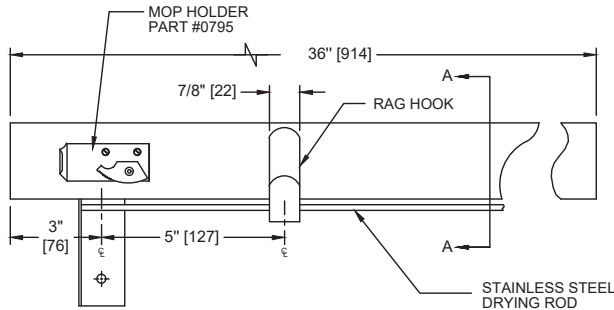

Scan for Information



SUSTAINABILITY/LEED

MR 4.1 (1) MR 6 (1) EQ 4.2 (1)
MR 4.2 (1) EQ 4.1 (1) EQ 4.4 (1)

NOTE:
ALL DIM'S INCH [MM]
ILLUSTRATION FOR REF ONLY AND NTS

PRODUCT OVERVIEW

Shelf fabricated of 18 gauge type 304 satin finish stainless steel, this shelf is 8" [203] deep with 3/4" [19] return for rigidity, mounting brackets shall be 16 gauge same material. Mop holders are riveted to strip, and rubber cam is ribbed for grasping. Rod and hooks for wet rags are included. 4 mop holders/3 rag hooks, 36" [914]. Pivoting spring loaded holders have serrated rubber cams for grasping.

KEY FEATURES & SPECIFICATIONS

- 3-in-1 storage for custodians
- With drying Rod
- Type 304 Stainless Steel - Satin Finish
- Surface Mounted
- 3 Hooks - 4 Holders
- 36" [914] Length

OPERATION & MAINTENANCE

Mop or broom handle is pushed into grip-jaw of pivoting serrated rubber cam with upward motion until it seats behind rib on clamp plate. Spring holds cam against handle. Gravity holds mop clamped in position. General dry janitorial supplies may be stored on shelf. Wet or dry cleaning rags may be hung on hooks as required. Wet cloth items may be hung on drying rod to drip into floor basin (by others).

TECHNICAL INFORMATION / PRODUCT PROPERTIES

Property	Value
Dimensions	36" [914] W x 6" [152] H x 9-1/8" [229] D
Construction	Type 304 Stainless Steel - Satin Finish
Mounting	Surface Mounted
Capacity	3 Hooks - 4 Holders

INSTALLATION

Unit is surface mounted on wall or partition having clear wall space to floor using #10 self-threading pan head screws into suitable wall anchors or other prepared blocking (all by others). For general utility, mount rack 72" [1829] Above Finished Floor (AFF) from top of shelf with #10 pan head self-threading screws (by others) through holes provided in gusset brackets. For compliance with 2010 ADA Accessibility Standards install unit so that top of hook is 48" [1219] maximum AFF.

WARRANTY

One (1) Year from date of Invoice