

# HUTTON 72" DOUBLE SINK BASE CABINET

# ARIEL

W072D



## BASE CABINET DIMENSIONS

72" W x 21.75" D x 18" H

## FEATURES

- Solid wood frame & plywood panels
- Dovetail drawers and joints
- Soft closing doors & drawers

## HARDWARE FINISHES



Brushed Nickel    Satin Brass    Matte Black    Polished Chrome

## AVAILABLE COLORS



White    Grey    Midnight Blue

FRONT VIEW

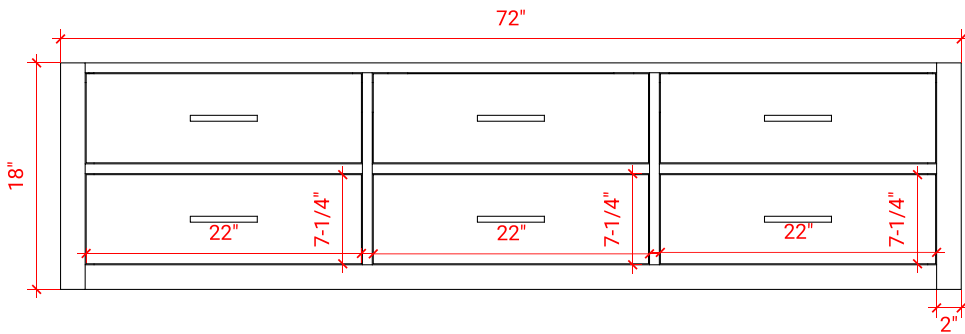

SIDE VIEW

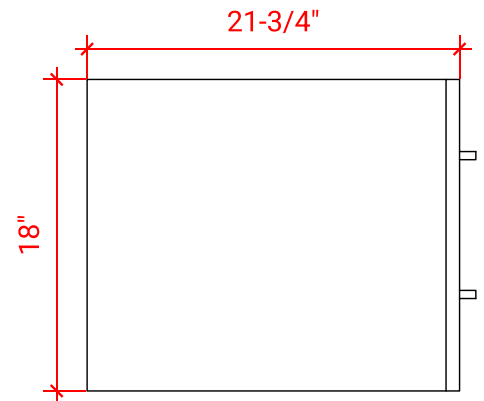

PLAN VIEW

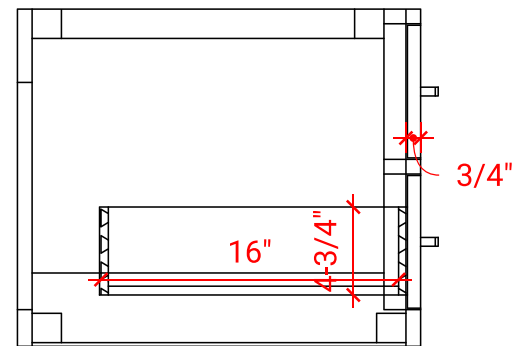
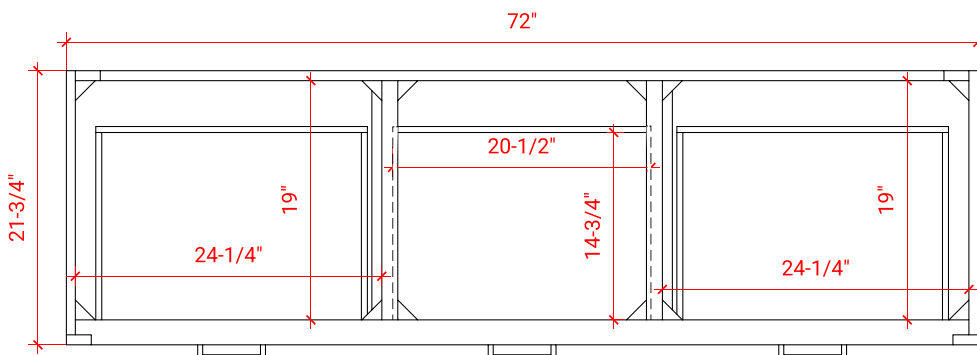

# 72" DOUBLE OVAL SINK COUNTERTOP WITH 1.5 IN. THICKNESS

# ARIEL

## OVERALL DIMENSIONS

72.25" W x 22" D x 1.5" H

## COUNTERTOP OPTIONS



Carrara White Quartz  
CQ-072D-OVL-CT

## FEATURES

- Solid countertop with mitered edges & seams
- Undermount white oval sink
- Pre-drilled for 8" widespread faucet

## INCLUDED

- Countertop
- Matching Backsplash
- Oval Sinks

## COUNTERTOP PLAN VIEW

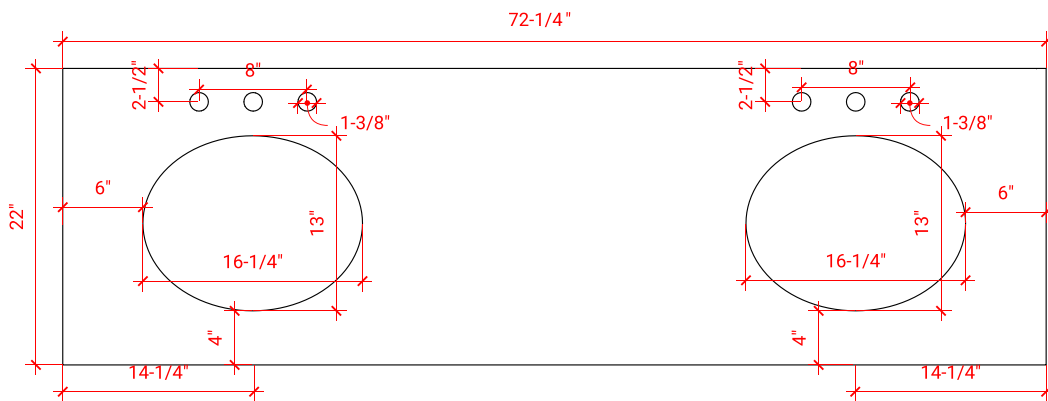

## EDGE SIDE VIEW

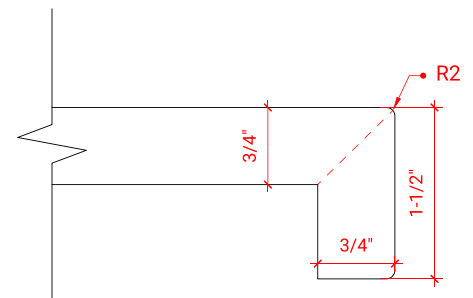

## THREE DIMENSIONAL COUNTERTOP VIEW

