

HUTTON 72" DOUBLE SINK BASE CABINET

ARIEL

W072D



BASE CABINET DIMENSIONS

72" W x 21.75" D x 18" H

FEATURES

- Solid wood frame & plywood panels
- Dovetail drawers and joints
- Soft closing doors & drawers

HARDWARE FINISHES



Brushed Nickel Satin Brass Matte Black Polished Chrome

AVAILABLE COLORS



White Grey Midnight Blue

FRONT VIEW

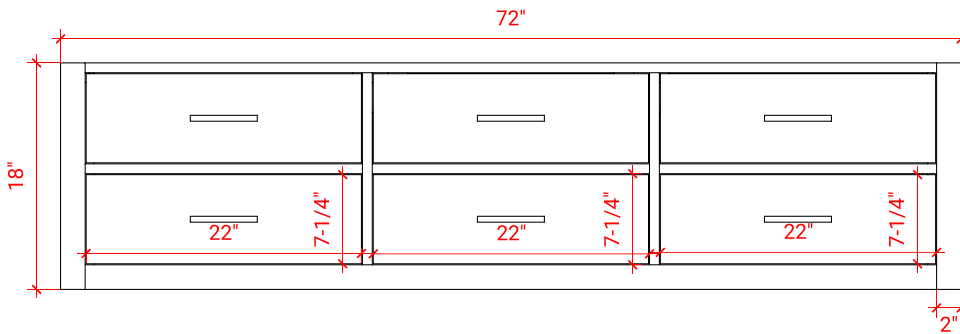

SIDE VIEW

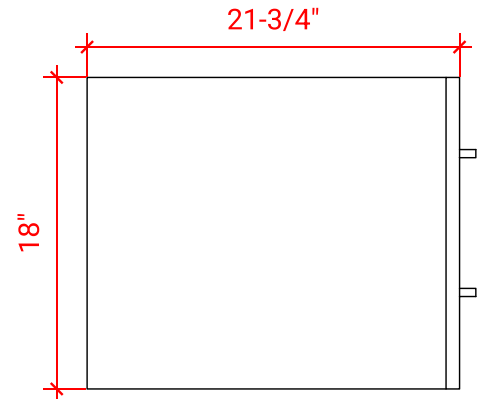

PLAN VIEW

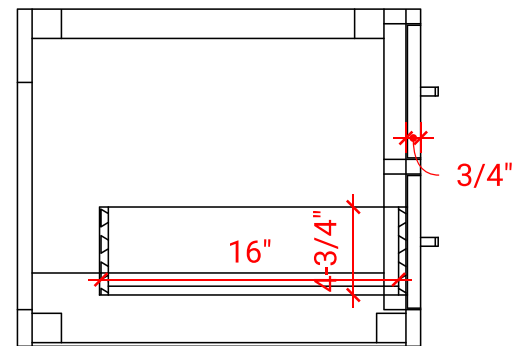
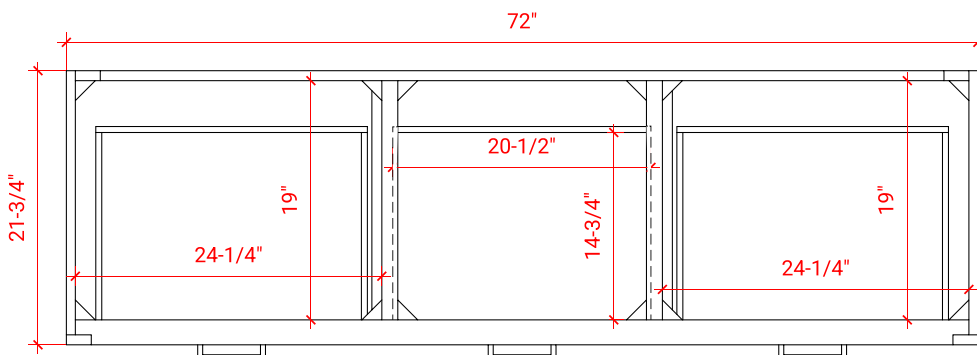

73" DOUBLE OVAL SINK COUNTERTOP WITH 1.5 IN. THICKNESS

ARIEL

OVERALL DIMENSIONS

73" W x 22" D x 1.5" H

COUNTERTOP OPTIONS



Carrara Marble
CW-073D-OVL-CT

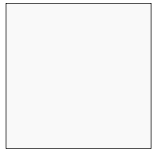

White Quartz
WQ-073D-OVL-CT

FEATURES

- Solid countertop with mitered edges & seams
- Undermount white oval sink
- Pre-drilled for 8" widespread faucet

INCLUDED

- Countertop
- Matching Backsplash
- Oval Sinks

COUNTERTOP PLAN VIEW

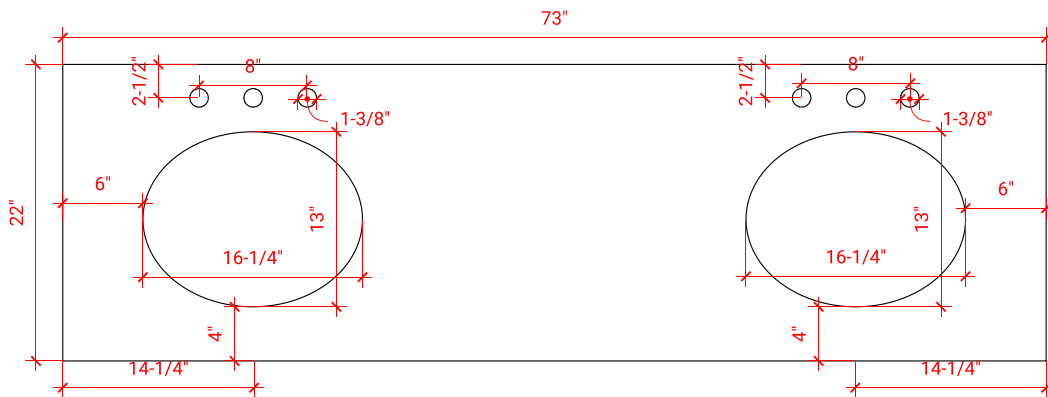

EDGE SIDE VIEW

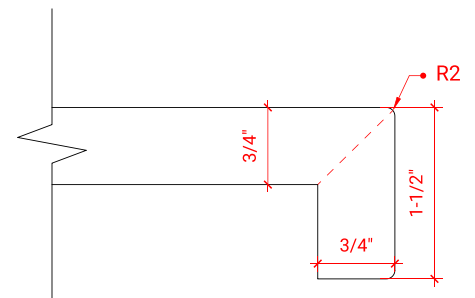

THREE DIMENSIONAL COUNTERTOP VIEW

