

# HUTTON 60" SINGLE SINK BASE CABINET

# ARIEL

W060S



## BASE CABINET DIMENSIONS

60" W x 21.75" D x 18" H

## FEATURES

- Solid wood frame & plywood panels
- Dovetail drawers and joints
- Soft closing doors & drawers

## HARDWARE FINISHES



Brushed Nickel    Satin Brass    Matte Black    Polished Chrome

## AVAILABLE COLORS



White    Grey    Midnight Blue

FRONT VIEW

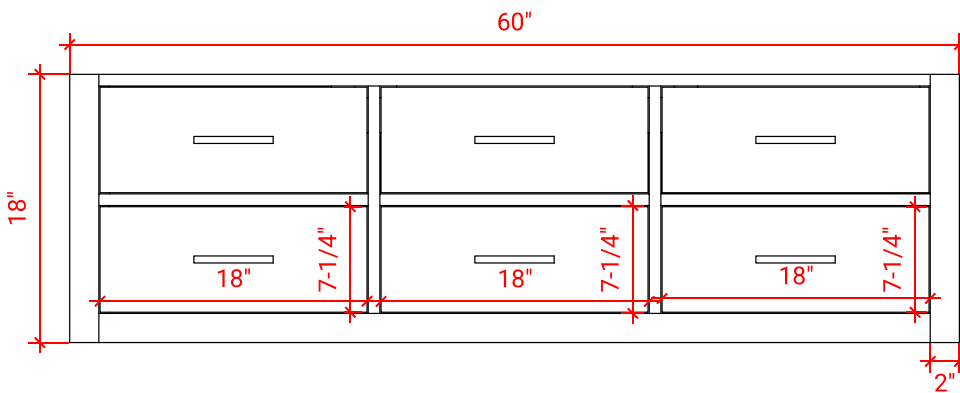

SIDE VIEW

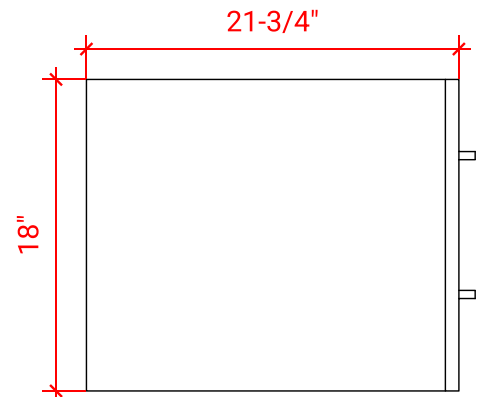

PLAN VIEW

