

K111



DIMENSION

- Diameter: 1.13"
- Base Diameter: 0.65"
- Projection: 0.75"

HARDWARE FINISHES



Brushed Nickel Polished Chrome Satin Brass Matte Black

FRONT VIEW

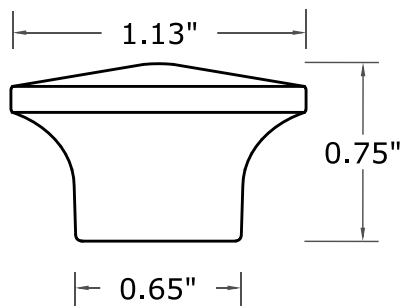

TOP VIEW

