

# TAYLOR 60" SINGLE SINK BASE CABINET



## BASE CABINET DIMENSIONS

60" W x 21.6" D x 34.5" H



## FEATURES

- Solid wood frame & plywood panels
- Dovetail drawers and joints
- Soft closing doors & drawers

## HARDWARE FINISHES\*



Brushed Nickel    Satin Brass    Matte Black    Polished Chrome

*Hardware comes preinstalled with the illustrated option. Other finishes are available on our online store if you prefer a different one.*

## AVAILABLE COLORS



White    Grey    Midnight Blue

### FRONT VIEW

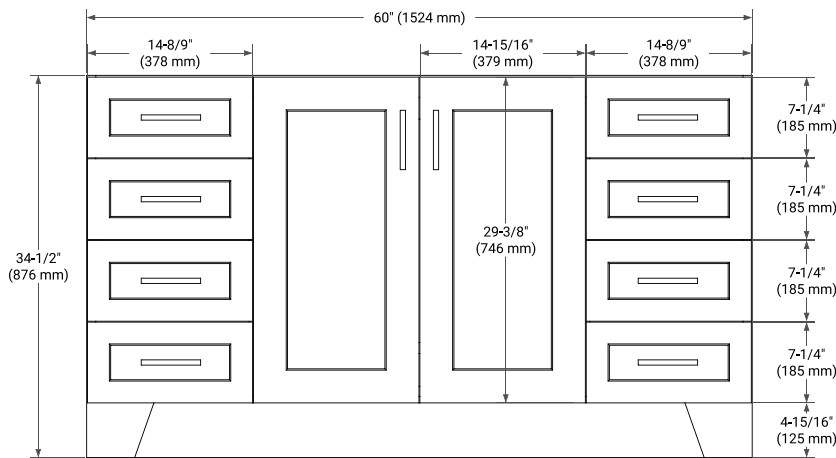

### SIDE VIEW

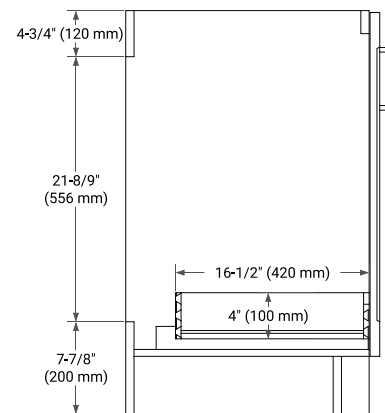

### PLAN VIEW

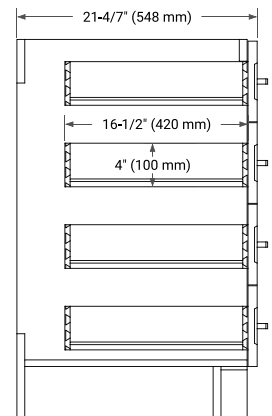
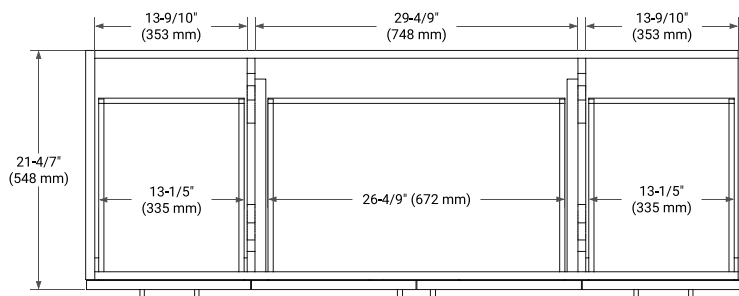

# 61" SINGLE RECTANGLE SINK COUNTERTOP WITH 1.5 IN. THICKNESS

# ARIEL

## OVERALL DIMENSIONS

61" W x 22" D x 1.5" H

## COUNTERTOP OPTIONS



Carrara Marble

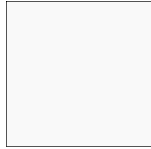

White Quartz

## FEATURES

- Solid countertop with mitered edges & seams
- Undermount white rectangular sink
- Pre-drilled for 8" widespread faucet

## INCLUDED

- Countertop
- Matching Backsplash
- Rectangle Sink

## COUNTERTOP PLAN VIEW

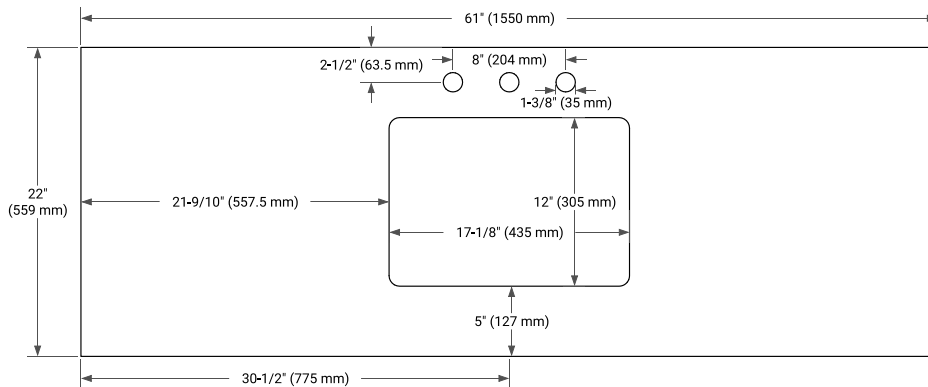

## EDGE SIDE VIEW

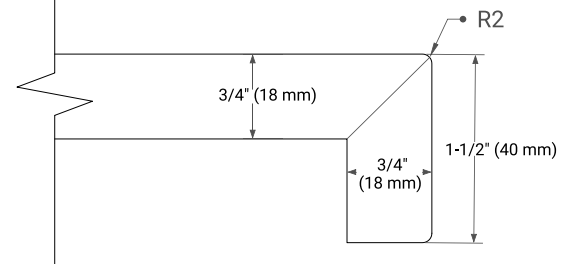

## THREE DIMENSIONAL COUNTERTOP VIEW

