

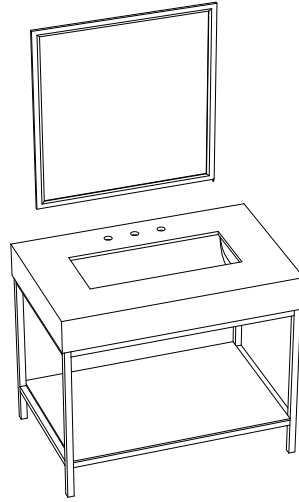

















Product Description / Description du Produit / Descripcion Del Producto**Product Measurements / Dimensions Du Produit / Medidas Del Producto**

- Width / Largeur / Ancho: 48" (121.92 cm)
- Depth / Profondeur / Profundidad: 23" (58.42 cm)
- Height / Hauteur / Alto: 33.9" (86.10 cm)

Before You Begin / Avant De Commencer / Antes De Comenzar

1. Prior to installation, unpack your new product and inspect it. Keep the product in its original package until you are ready to install it.
 2. The wall must be square, plumb and level.
 3. Shut the water supply off when replacing an existing fixture. Preparation of the floors and walls, including all additional wall supports, may be required.
 4. Observe all local plumbing and building codes.
 5. It is recommended that this installation be done with a minimum of two people. Do not install this fixture alone.
 6. strongly recommends using a professional and certified plumber to install this fixture.
1. Avant de proceder a l'installation, deballez votre nouveau produit et verifiez son etat. Conservez le produit dans son emballage d'origine jusqu'a ce que vous soyez pret a l'installer.
 2. Le mur doit etre droit, d'aplomb et de niveau.
 3. Coupez l'alimentation en eau avant de retirer le lavabo deja en place. La preparation des planchers et des murs, notamment l'installation de supports muraux supplementaires, peut s'averer necessaire.
 4. Conformez-vous a tous les codes de plomberie et a tous les codes de construction locaux.
 5. Nous recommandons un minimum de deux personnes pour l'installation de ce produit. Ne tentez pas d'installer ce produit seul.
 6. recommande fortement l'utilisation d'un plombier professionnel et certifie pour installer cet appareil.
1. Antes de la instalacion, saque su nuevo producto de la caja e inspeccionelo. Mantenga el producto dentro de su empaque original hasta que tenga todo listo para instalarlo.
 2. La pared debe estar a escuadra, a plomo y a nivel.
 3. Cuando reemplace una instalacion existente, cierre la llave de paso del agua. Puede ser necesario preparar los pisos y las paredes, incluso pueden ser necesarios soportes de pared adicionales.
 4. Respete todos los codigos locales de plomeria y construccion.
 5. Se recomienda realizar la instalacion entre dos personas como minimo. No realice la instalacion usted solo.
 6. recomienda el uso de un plomero profesional y certificado para instalar este aparato.

Recommended Tools / Outils Recommandés / Herramientas Recomendadas

					
Tape Measure / Ruban à mesurer / Cinta Métrica	Pencil / Crayon / Lápiz	Ruler / Règle / Regla	Pipe Wrench / Clé à tuyau / Llave inglesa	Adjustable Wrench / Clé à molette / Llave ajustable	Level / Niveau / Nivel
					
Channel Locks / Pince Multiprise / Pinzas de extensión	Goggles / Lunettes / Gafas	Hacksaw / Scie à métaux / Sierra de mano	Putty Knife / Couteau à mastic / Espátula	Plumber's Putty/Caulking / Mastic de plomberie/calfeutrage / Masilla para plomería/sellador	Pipe Cutter / Coupe-tuyau / Cortador de tubería
					
Flathead Screwdriver / Tournevis plat / Destornillador plano	Phillips Screwdriver / Tournevis cruciforme / Destornillador Phillips	Drill / Perceuse / Taladro	Pipe Clamp / Collier de serrage pour tuyau / Abrazadera de tubería	Square / Équerre / Escuadra	Jig Saw / Scie à découper / Sierra de sable

Parts / Pièces / Piezas

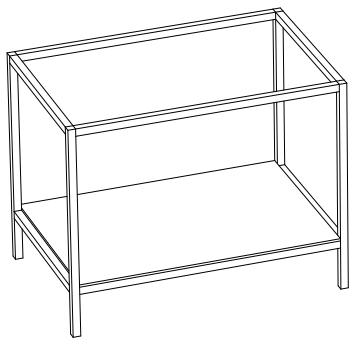

A

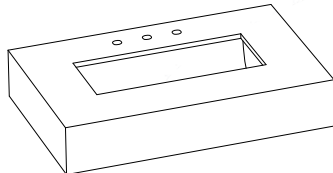

B

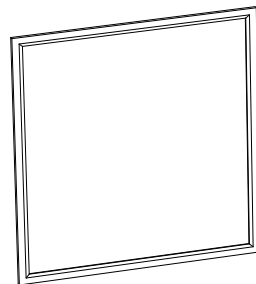

C

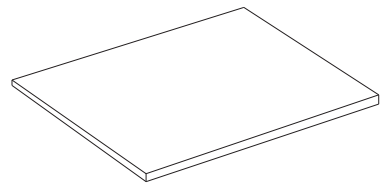

D

Item	Description	Qty.
A	Vanity / Vanité / Vanidad	1
B	Countertop / Comptoir / Mostrador	1
C	Mirror / Miroir / Espejo	1
D	Glass shelf / De support de verre / Estante de vidrio	1

Roughing-In Dimensions / Mesures Relatives aux Points de Raccordement / Medidas Aproximadas

UNITS IN INCHES (") / UNITÉS EN POUÇES (") / UNIDADES EN PULGADAS (")

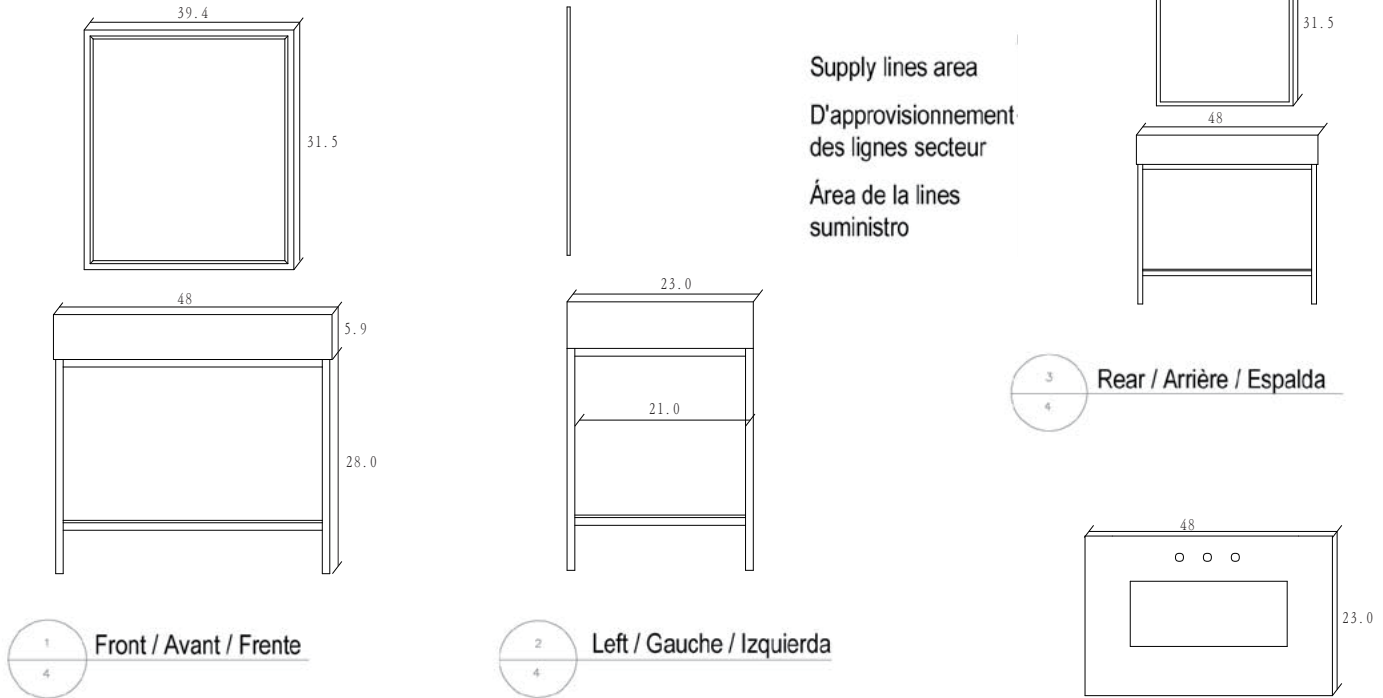

Note: Height may vary depending on material of top
 Note: La hauteur peut varier en fonction du matériau du top
 Nota: La altura puede variar dependiendo del material de los mejores



Recommended Accessories / Accessoires Recommandés / Accesorios Recomendados

- Classic Faucet - Reckline Faucet - Varese Faucet - SS8/SS12 - MC27 - MCG24
- Curviz Faucet - Robo Faucet - Bamboo Faucet - MC22 - MCG18

STEP #1

- With assistance, place vanity (A) in desired location and level.
- It is recommended to locate at least one wall stud within area where vanity (A) is to be installed. Pre-drill holes through wall studs. Using wood screws, fasten vanity to wall stud.
- NOTE: Wood screws are not provided! Refer to Figure #1.

Installation Instructions / Instructions D'Installation / Instrucciones De Instalación

ÉTAPE 1

- Avec l'aide d'une autre personne, placez le meuble-lavabo (A) à l'emplacement désiré et le niveau.
- Il est conseillé de repérer au moins un poteau mural près de l'endroit où sera installé le meuble-lavabo (A). Percez les avant-trous dans la traverse en bois horizontale supérieure et dans le poteau mural. Utilisez des vis à bois pour fixer le meuble-lavabo dans la traverse en bois horizontale supérieure.
- REMARQUE: Les vis à bois ne sont pas fournies! Reportez-vous à la Figure 1.

PASO N° 1

- Con la ayuda de otra persona, coloque el tocador (A) en la posición deseada y el nivel.
- Se recomienda ubicar por lo menos un montante dentro del área donde se va a instalar el tocador (A). Haga agujeros en el travesaño superior horizontal de madera y en el montante de pared. Usando tornillos para madera, sujete el tocador al montante de pared a través del travesaño superior horizontal de madera.
- NOTA: Los Tornillos para madera no están incluidos! Vea la Figura 1.

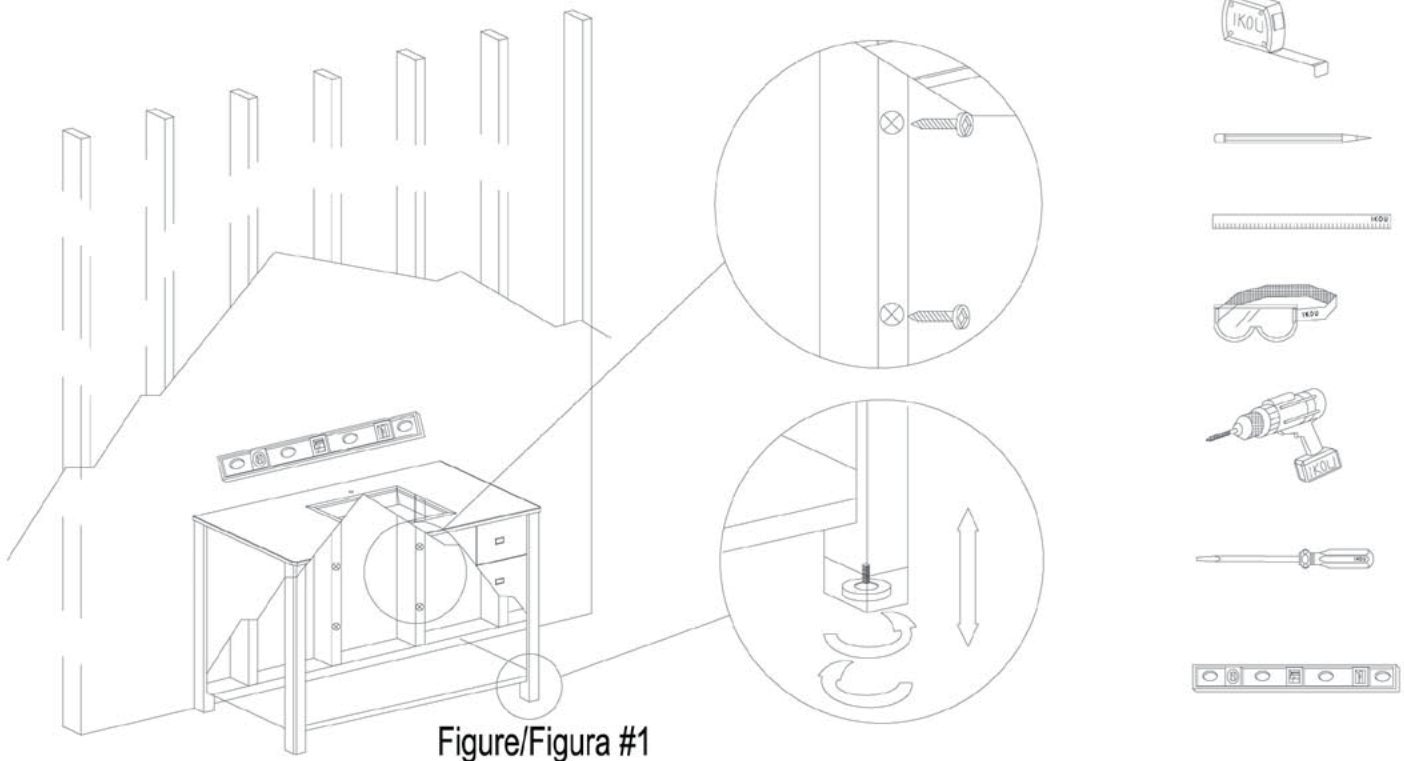

Figure/Figura #1

Installation Instructions / Instructions D'Installation / Instrucciones De Instalación

STEP #2

- Install drain and faucet assembly according to manufacturer's installation instructions.
- Refer to Figure #2A and #2B

ÉTAPE #2

- Installez l'assemblage du drain et le robinet conformément aux instructions d'installation du fabricant.
- Reportez-vous à la Figure 2A et 2B.

PASO Nº 2

- Instale el conjunto de desagüe y el grifo según las instrucciones de instalación del fabricante.
- Vea la Figura 2A y 2B.

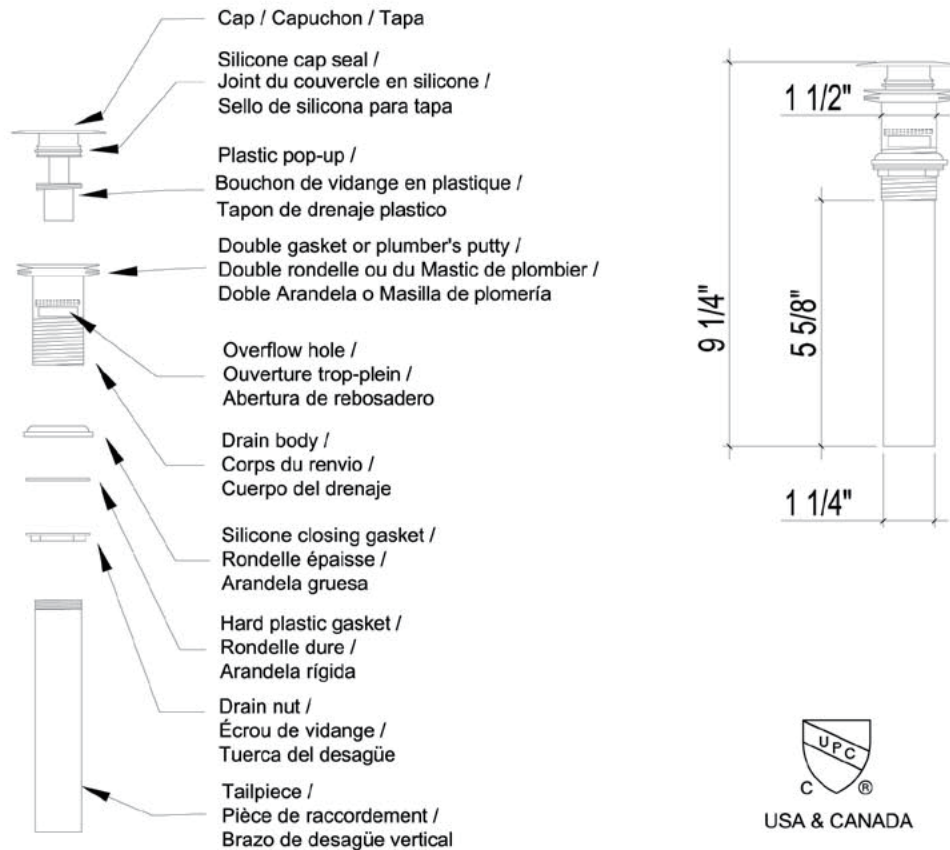

Figure/Figura #2A

Entretien et Nettoyage

- NE PAS TROP SERRER LES LIGNES DE VIDANGE ET ALIMENTATION. Cela peut entraîner des dommages à votre produit, ainsi que les fuites d'eau cause.
- N'UTILISEZ PAS de produits contenant des détergents, de l'acide, des abrasifs ou des nettoyeurs forts, ni de chiffon à surface rugueuse. Ce conseil s'applique à tout produit de plomberie, peu importe le type de matériau.
- NE LAISSEZ AUCUN produit nettoyant autre que de l'eau sur votre produit
- NE LAISSEZ PAS d'objets solides heurter votre produit inutilement.
- NETTOYEZ votre produit à l'aide d'un chiffon humide et séchez-le avec un chiffon doux. Au besoin, utilisez une solution d'eau et de savon doux d'application générale.
- NETTOYEZ le dessous de votre produit avec de l'eau et du savon doux SEULEMENT.
- ESSUYEZ votre produit à l'aide d'un chiffon doux, sec et propre après chaque utilisation pour limiter la formation de taches causées par l'eau, plus particulièrement dans les régions où l'eau est calcaire.
- NETTOYEZ votre miroir Essuyer avec un nettoyant pour vitres et un chiffon doux et propre. Utilisez un poli furniture doux pour nettoyer le bois.
- recommande de sceller adéquatement TOUS les produits en pierre naturelle AVANT DE PROCÉDER À L'INSTALLATION.

Cuidado Y Limpieza

- NO APRIETE DE LAS LÍNEAS DE DRENAJE O SUMINISTRO. Esto puede provocar daños en el producto, así como fugas de agua causa.
- NO limpie el producto con detergentes, ácidos, abrasivos, limpiadores fuertes ni paños cuyas superficies no sean lisas, como los paños.
- Este consejo es útil para todos los accesorios de plomería, sin importar cuál sea al material.
- NO deje agentes de limpieza, salvo agua, sobre su producto
- NO deje que su producto entre en contacto innecesario con otros objetos sólidos.
- LIMPIE su producto. Limpie con un paño húmedo y seque con un paño suave. Si es necesario, puede usar una solución de jabón suave y agua.
- LIMPIE la parte inferior de su producto SOLAMENTE con jabón suave y agua.
- SEQUE su producto con un paño limpio, suave y seco luego de cada uso para evitar las machas producidas por el agua, especialmente en áreas con agua dura.
- LIMPIE su espejo. Limpie con un limpiador de vidrios y un paño suave y limpio. Use un limpiador suave para limpiar furniture marco de madera.
- recomienda sellar correctamente TODOS los productos de piedra natural ANTES DE LA INSTALACIÓN.

Installation Instructions / Instructions D'Installation / Instrucciones De Instalación

STEP #3

- Apply silicone to bottom edge of the countertop (B).
- Place the countertop (B) carefully in position.
- Align countertop (B) to vanity (A) and wipe off excess silicone if needed.
- Refer to Figure #3

 Optional: if suction cups [4x] are present, install them in the corresponding holes on the vanity top. See Figure (1).

ÉTAPE #3

- Appliquez de la silicone autour de la partie inférieure du comptoir (B).
- Positionnez délicatement le comptoir (B).
- Alignez le lavabo en comptoir (B) avec le meuble-lavabo (A) et essuyez l'excédent de silicone au plateau.
- Reportez-vous à la Figure 3.

 Facultatif: si ventouses [4x] sont présents, les installer dans les trous correspondants sur le dessus de vanité. Voir figure (1).

PASO N° 3

- Aplique silicona al borde inferior del encimera de mostrador (B).
- Coloque el encimera de mostrador (B) cuidadosamente en su lugar.
- Alinee el encimera de mostrador (B) con el tocador (A) y quite el excedente de silicona si fuera necesario.
- Vea la Figura 3.

 Opcional: si las copa de succión [4x] están presentes, instáuelos en los agujeros correspondientes en la tapa de la vanidad. Véase la figura (1).

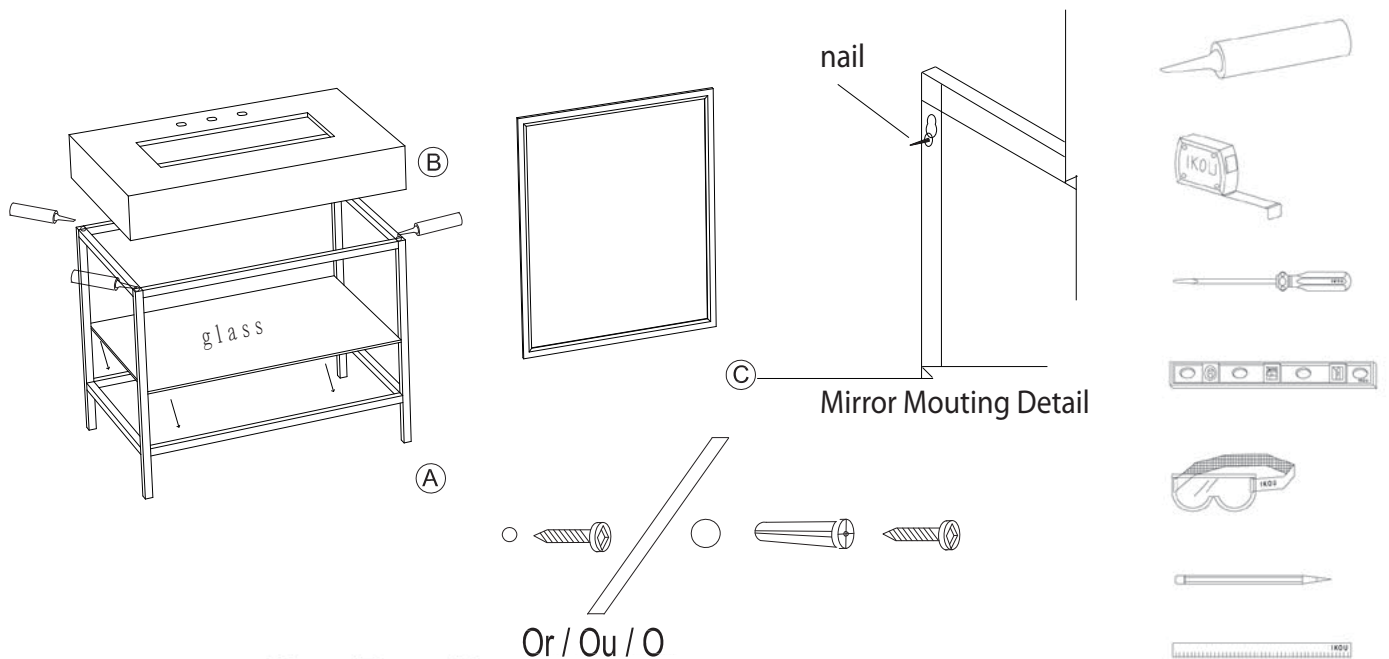

Figure/Figura #3

Limited 2-year Warranty

ARIEL BATH warranties all our products to the original end consumer to be free of true defect(s) in material and workmanship for two (2) years from the date of initial purchase, subject to the following restrictions:

- ARIEL BATH is notified promptly in writing, via fax, mail or email, by the Retailer/Wholesale Purchase upon discovery of any alleged defect(s) in the product(s), including a detailed description of the alleged defect(s).
- Proof of purchase (original sales receipt) from the original end consumer must be made available to ARIEL BATH for all warranty claims.
- Authorized ARIEL BATH personnel has inspected the product(s) and determined the product(s) to have true manufacturing defect(s)

The Limited Two-Year Warranty is non-transferable and applies only to the original end consumer and to the original installation of the product(s). This Limited Two-Year Warranty is void if the product(s) has been moved from its initial installation site or if the ownership of the product(s) has changed.

ARIEL BATH's products are produced from natural raw materials and there is a slight color variance. This is NOT a manufacturing defect and will not be covered under the Limited Two-Year Warranty. This Limited Two-Year Warranty does not apply to local building code compliance. Since local building codes vary considerably, the original end consumer of the product(s) should check with a local building or plumbing contractor to ensure local code compliance before installation. This Limited Two-Year Warranty does not cover any mechanical pieces of any ARIEL BATH product(s). These mechanical pieces will be covered under a Limited One Year Warranty, based on the same criteria as this Limited Two-Year Warranty, from the date of initial purchase. Upon satisfaction of each of the foregoing conditions and requirements, ARIEL BATH shall, at its option, either repair or replace such defective product(s). ARIEL BATH shall return any product(s) repaired or replaced under this Limited Two-Year Warranty to the original end consumer transportation prepaid. All discontinued product(s), at the time of claim, will either be repaired or replaced with a comparable item. ARIEL BATH's option to repair or replace the product(s) under this Limited Two-Year Warranty does not cover any cost of labor, installation, usage and delay time, or other costs of removal or installation whatsoever. IN NO EVENT WILL ARIEL BATH BE LIABLE FOR THE COST OF REPAIR OR REPLACEMENT OF ANY INSTALLATION MATERIALS, INCLUDING BUT NOT LIMITED TO TILES, MARBLE, ETC... This Limited Two-Year Warranty does not cover any liability for consequential or incidental damages, all of which are hereby expressly disclaimed, or the extension beyond the duration of this Limited Two-Year Warranty.

THE WARRANTIES HEREIN (A) ARE EXCLUSIVE AND STATED IN LIEU OF ALL OTHER WARRANTIES, WHETHER EXPRESS, STATUTORY, OR IMPLIED, INCLUDING BUT NOT LIMITED TO THE WARRANTIES OF MERCHANTABILITY AND FITNESS FOR AN INTENDED PURPOSE, ALL OF WHICH ARE HEREBY EXPRESSLY DISCLAIMED, (B) NEITHER ASSUME NOR AUTHORIZE PURCHASER NOR ANY OTHER PARTY TO ASSUME FOR ARIEL BATH ANY OTHER LIABILITIES IN CONNECTION WITH THE MANUFACTURE OR SALE OF PRODUCTS; AND (C) ARE SUBJECT TO THE LIMITATIONS ON DAMAGES AS SET FORTH ABOVE.