

ADAPT™ PREMIUM CONDENSING TANKLESS WITH X3® SCALE PREVENTION TECHNOLOGY & INTEGRATED RECIRC PUMP

Introducing A. O. Smith's ADAPT™ premium condensing gas tankless water heaters, delivering robust, on-demand performance and the flexibility to install in practically any residential setting.

FEATURES:

X3® SCALE PREVENTION TECHNOLOGY (PATENTED DESIGN)

- Integrated into all X3 models; optional accessory for Bypass (M) models and can be added at any time
- No annual descaling required with X3 models
- X3 models maintain like-new performance longer; extends life up to three times versus unprotected unit

HEAVY DUTY STAINLESS-STEEL HEAT EXCHANGER DESIGN

- Single stainless steel, heavy-duty heat exchanger design eliminates most internal welds and improves overall reliability
- More resilient to scale buildup and corrosion

INTEGRATED RECIRCULATION PUMP & DISPLAY

- Integrated recirculation pump
- Built-in Control Display to set and review recirc schedules, status, and error codes
- Optional remote activation (Ca. Title 24) kits available

PERFORMANCE & EFFICIENCY

- 160,000, 180,000, 199,000 BTU/h
- 9,000 BTU min. input
- 22:1 Turndown Ratio (199k configurations)
- Max Flow Rate 10.5 GPM; 0.4 GPM activation; 0.26 GPM for continuous fire
- 0.95 UEF, ENERGY STAR® certified
- Ultra Low NOx – Complies with SCAQMD Rule 1146.2*

ULTIMATE FLEXIBILITY EASE OF INSTALLATION

- Universal indoor or outdoor installation; Outdoor Vent Cap Kit sold separately
- Field convertible from Natural Gas to Liquid Propane, kit included
- ½" Gas Line or larger
- Exhaust venting, 2" PVC up to 75' (23 m); 3" PVC up to 150' (45.7 m)
- Cat. IV venting may be used
- Flexible venting with PVC, CPVC, Polypropylene, or ABS Pipe (solid core only)
- Pressure relief valve included with X3 models
- Outdoor rated power cord standard on every unit
- Cascade up to 12 units with single cable per heater, cable included
- Approved for installation in manufactured homes

WARRANTY

- No hardwater exclusions on X3 models; exclusions apply to M models
- 15-year limited warranty on heat exchanger in residential applications
- 5-year limited warranty on all parts in residential applications
- 1-year limited warranty on heat exchanger and parts in commercial applications

*Ultra Low NOx – Complies with SCAQMD Rule 1146.2 and other air quality management districts with similar NG NOx emission requirements of 14 ng/J or 20 ppm. Complies with SJVAPCD Rule 4308 and other air quality management districts with similar LP NOx emission requirements of 77 ppm.



**ATHR-160X3, ATHR-180X3,
ATHR-199X3**
with Integrated X3 Scale
Prevention Technology



Optional Outdoor Vent Cap Kit
sold separately; Fits all ATHR-X3
and ATHR-M models.



**ATHR-160M, ATHR-180M,
ATHR-199M**
with Bypass Cartridge - easily add
X3 Scale Prevention any time as
optional accessory



CSA/ANSI Z21.10.3 • CSA 4.3



COMMERCIAL-GRADE RESIDENTIAL GAS WATER HEATERS

ADAPT™ PREMIUM CONDENSING TANKLESS WITH X3® SCALE PREVENTION TECHNOLOGY & INTEGRATED RECIRC PUMP

		ATHR-160M	ATHR-160X3	ATHR-180M	ATHR-180X3	ATHR-199M	ATHR-199X3
Installation Type		Indoor / Outdoor*		Indoor / Outdoor*		Indoor / Outdoor*	
X3® Scale Prevention Technology		Optional Accessory	Integrated	Optional Accessory	Integrated	Optional Accessory	Integrated
Recirculation Pump		Integrated					
Gas Consumption Input	Min. BTU/H	9,000					
	Max. BTU/H	160,000		180,000		199,000	
Fuel Type		Natural Gas (Field Convertible to Liquid Propane, Kit Included)					
Heat Exchanger		Stainless Steel					
Uniform Energy Factor (UEF)		0.95					
Maximum GPM**		10.5 GPM					
Activation GPM		0.4 GPM					
Continuous Fire GPM		0.26 GPM					
Water Pressure Min. - Max.		15 - 150 PSI (40 PSI Recommended for Maximum Flow)					
Supply Gas Pressure (NG)	Min. in W.C. (kPa)	3.5 (0.9)					
	Max. in W.C. (kPa)	10.5 (2.6)					
Supply Gas Pressure (LP)	Min. in W.C. (kPa)	8.0 (2)					
	Max. in W.C. (kPa)	13.0 (3.2)					
Hot/Cold Connections		3/4" NPT					
Gas Connection		1/2" NPT					
Temperature Settings Min. - Max.		100°F (38°C) - 140°F (60°C); Default 120°F (49°C)					
Ignition System		Electronic Ignition					
Power Supply		120V, 50Hz/60Hz, <5A					
Sound Level		50.3 dB**					
Elevation		Certified from Sea Level to 10,100' (3,078.5 m)					
Freeze Protection*		- 5°F (-21°C)					
Venting - Exhaust, Intake	Type	Power Direct Vent					
	Size, Max Run	2", 75' (5.08 cm, 22.9 m); 3", 150' (7.6 cm, 45.7 m)					
	Material	Cat. IV; PVC, CPVC, Polypropylene (Solid Core Only), Power Vent					
Dimensions - Unit	Height***	33.8" (85.9 cm)	41.8" (106.2 cm)	33.8" (85.9 cm)	41.8" (106.2 cm)	33.8" (85.9 cm)	41.8" (106.2 cm)
	Width	16.5" (42 cm)					
	Depth	16.1" (41 cm)					
	Weight	104 lb. (47.2 kg)					
Dimensions - Shipping****	Height	20.8" (52.7 cm)					
	Width	22.3" (56.5 cm)					
	Depth	40" (101.6 cm)					
	Weight	125 lb (56.7 kg)					

All models are Energy Star® certified.

* Universal install; outdoor installation requires outdoor vent cap kit (Part No. 100369060) sold separately

** Current numbers based on factory settings

***Height with required cartridge installed; M models with Bypass Manifold cartridge, X3 models with Scale Control Media cartridge. From flue collar to tip of cartridge.

****Packaged and shipped on unit back.

*Internal freeze protection for heater only; both Bypass cartridge and X3 cartridge require anti-freeze kits sold separately

Included with Heater: Manual, Pressure Relief Valve (X3 models only), Wall Mounting Bracket and Hardware, Vent Port Screws, Cascading Cable, Fuel Conversion Kit, Bird Screens

PREMIUM CONDENSING TANKLESS WITH X3® SCALE PREVENTION TECHNOLOGY DIMENSIONS

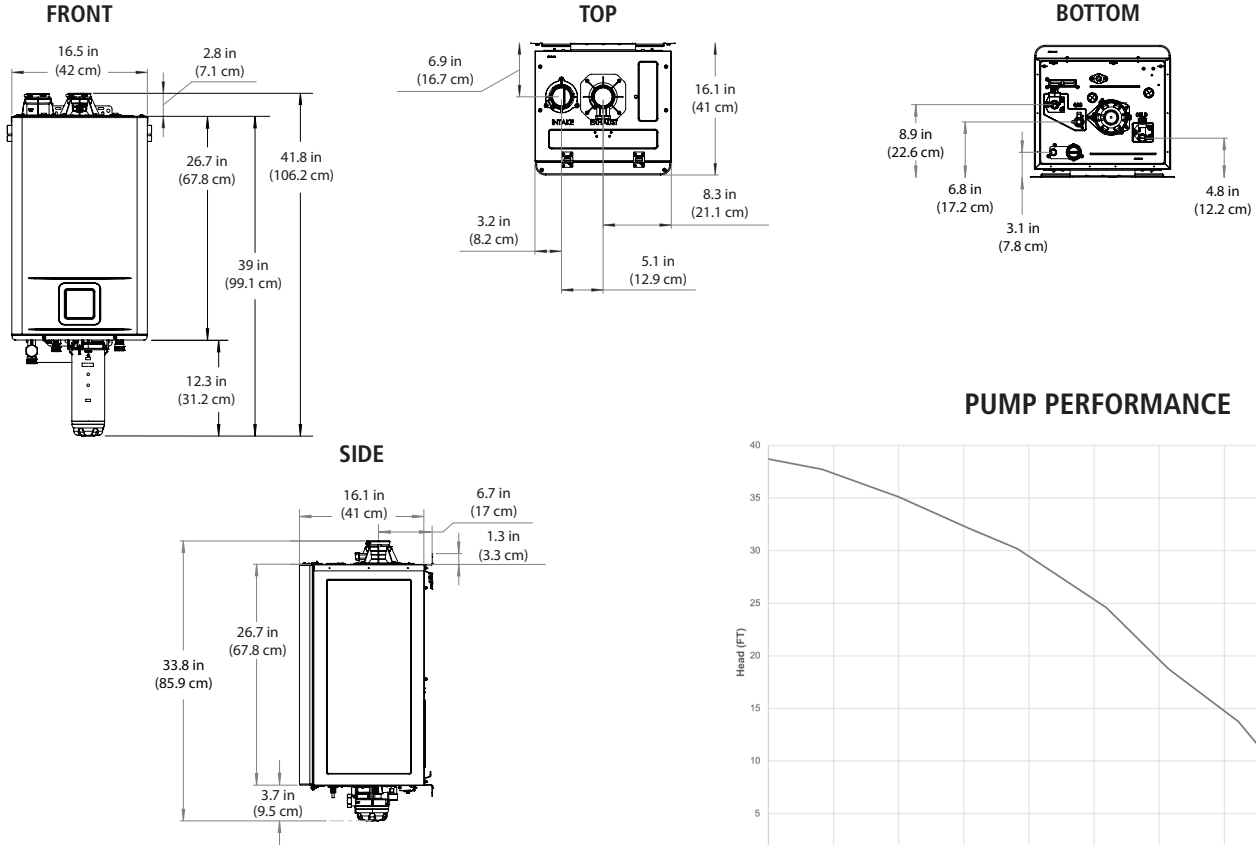

PUMP PERFORMANCE

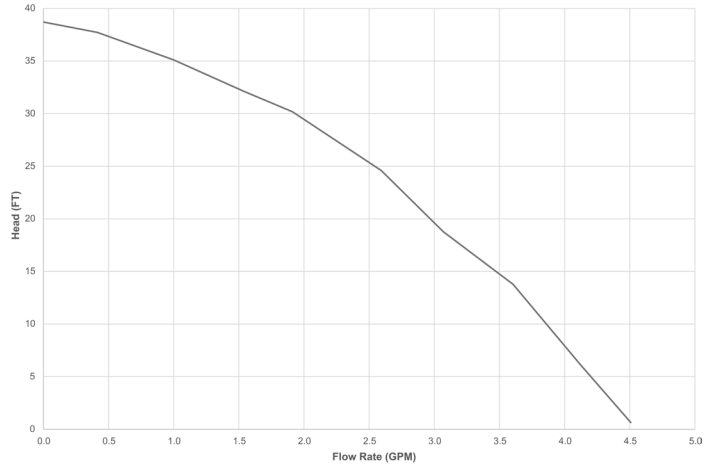



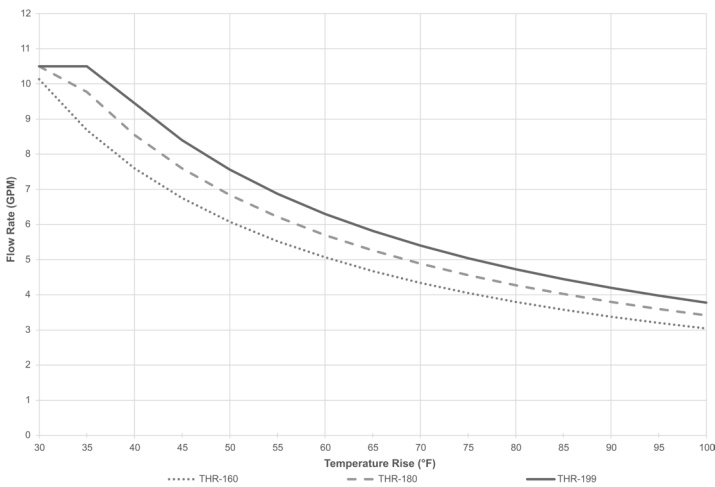



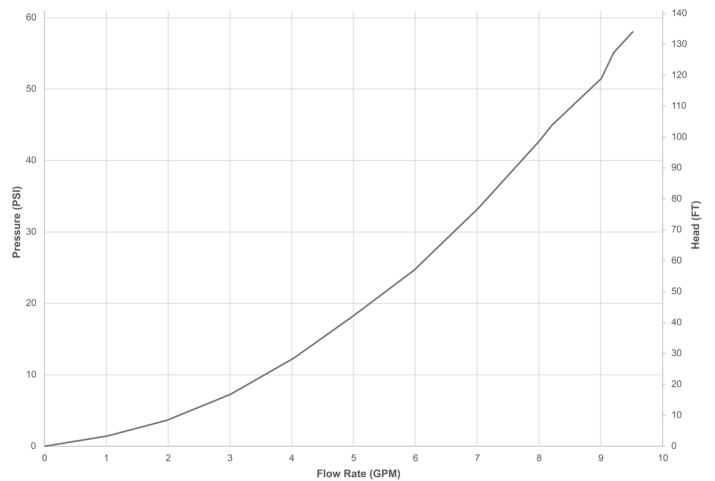

THR FLOW RATE CAPACITY

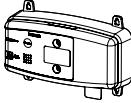
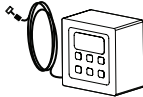
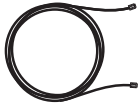
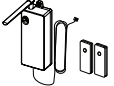
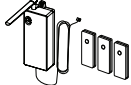

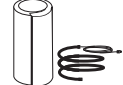
PRESSURE LOSS

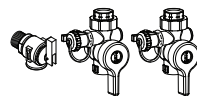

PREMIUM CONDENSING TANKLESS WITH X3® SCALE PREVENTION TECHNOLOGY

Item		Description
X3 Cartridge 100368986		Add to an M model heater to prevent scale buildup and eliminate the need for annual descaling maintenance.
Wi-Fi Module Kit 100371922		Wi-Fi Module for electronically connecting tankless water heaters to the internet and adapter to connect to the water heater. • Module (1x) • Cable (1x) • Adapter (1x)
Remote Temperature Controller 100377310		Remote Temperature Controller with 10' (3 m) cable.
Communication Cable - 10' (3 m) 100377341		Replacement Communication Cable for Remote Temperature Controller or WIFI Module, or On-Demand Receiver, 10' (3 m).
Communication Cable - 32' (10 m) 100377342		Extended Communication Cable for Remote Temperature Controller or WIFI Module, or On-Demand Receiver, 32' (10 m).
Remote Recirculation Kit - Two Buttons 100371920		Remote Recirculation Kit engages heater and recirculation at a touch of a button for on-demand hot water. Kit contains: Receiver (1x), Buttons (x2)
Remote Recirculation Kit - Three Buttons 100371921		Remote Recirculation Kit engages heater and recirculation at a touch of a button for on-demand hot water. Kit contains: Receiver (1x), Buttons (x3)
Individual Spare Button 100377309		Add more Remote Recirculation Buttons to a system as needed. Add up to a maximum of 30 buttons.
X3 Freeze Protection (X3 Models) 100325654		X3 Cartridge Freeze Protection can add an extra layer of freeze protection to external SCM cartridge. Cartridge not protected by heater's internal freeze protection.
Bypass Freeze Protection (M Models) 100371918		Bypass Freeze Protection can add an extra layer of freeze protection to external Bypass cartridge. Cartridge not protected by heater's internal freeze protection.
Pipe Cover 100374697		Pipe Cover protects plumbing connections to the heater while improving the appearance of the installation. Affixes to bottom of heater.
Neutralizer Assembly Kit 100112159		Neutralizer Assembly neutralizes the condensate (acidic water) that forms in the heat exchanger of the water heater. It connects to the condensate drain port of the water heater by using connectors included with the neutralizer kit.
Outdoor Vent Cap Kit 100369060		Vent cap kit and accessories for installing the tankless heater outdoors. Kit contains: • Vent Cap (1x) • User Interface Overlay (1x)
Isolation Valve Kit with Pressure Relief Valve 100112156		Isolation Valve supports routine maintenance and allows for draining and flushing the heater; whereas, the Pressure Relief Valve, as the name implies, serves to limit internal pressure in the system. Not necessary for X3 models. Check local codes for applicability.
Cross Over Valve Kit 100327167		For plumbing systems without a dedicated return line necessary for recirculation system functionality. Install at the faucet furthest from the hot water heater.

For Technical Information, call 800-527-1953. A. O. Smith Corporation reserves the right to make product changes or improvements without prior notice.