

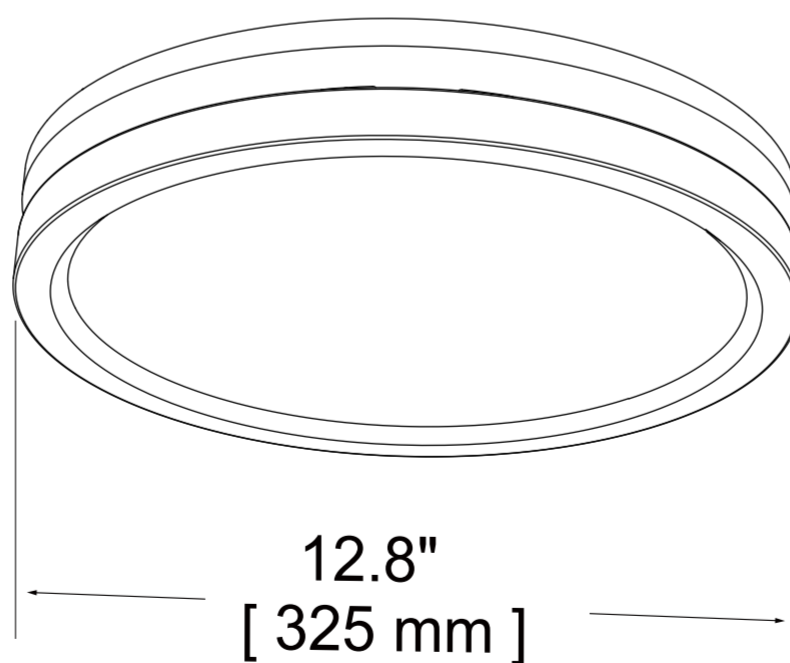

# EF-AZ108WH

## EXHAUST FAN

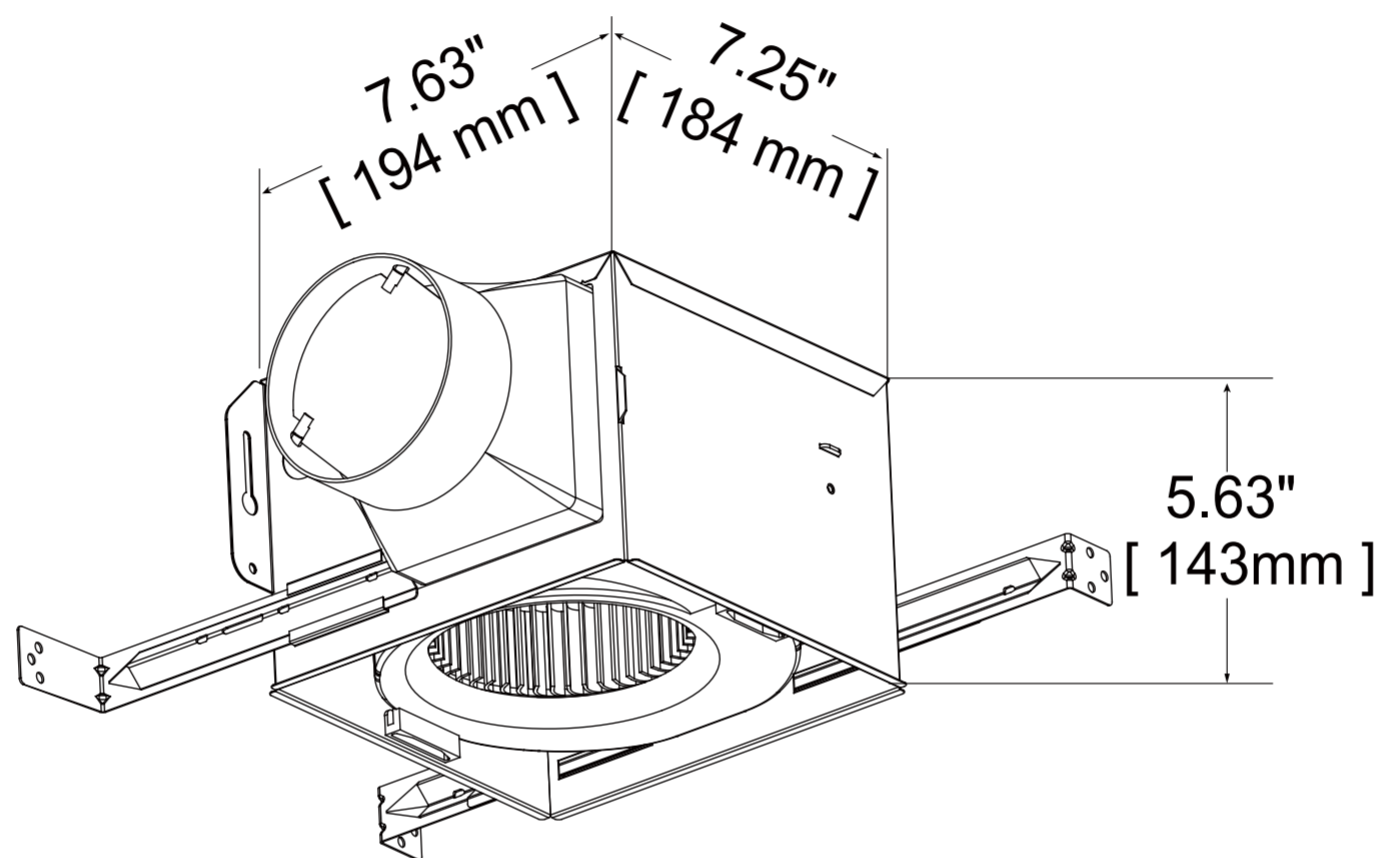

This fan can be installed to 7.7" - 24" between the joist or to I-joists, standard joists and truss construction.

HAVE QUESTIONS? CALL [305-614-4070](tel:305-614-4070) OR VISIT [ANZZI.COM](http://ANZZI.COM)