

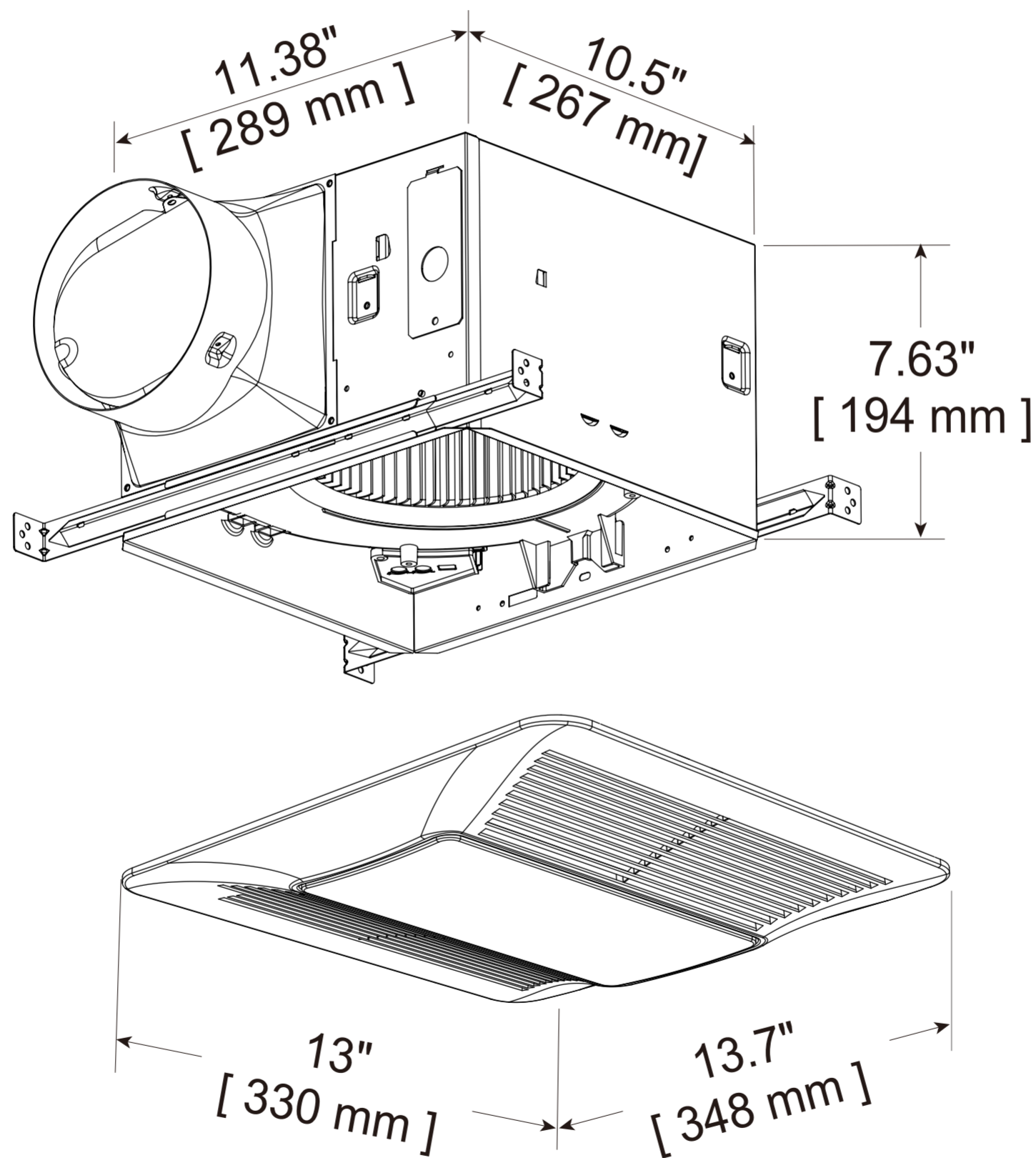

EF-AZ105WH

EXHAUST FAN



This fan can be installed to 13.8" - 24" between the joist or to I-joists, standard joists and truss construction.

HAVE QUESTIONS? CALL 305-614-4070 OR VISIT [ANZZI.COM](https://www.anzzi.com)