

ANZZI®

ITEM: TL-MBSEL200WH
TL-MBSRN201WH

ANZZI SOFT CLOSE MANUAL BIDET SEAT
INSTALLATION & OPERATION MANUAL

V1.2
05/30/2022

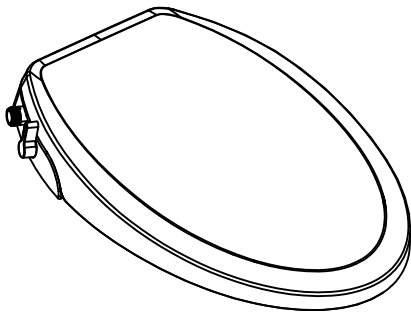

TL-MBSEL200WH

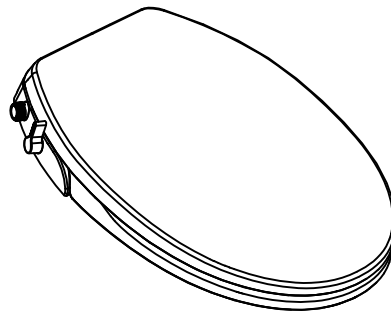

TL-MBSRN201WH

**DON'T WAIT!
REGISTER NOW!**

Register your product within 90 days to ensure your product is recognized as an official purchase and is eligible for warranty coverage.

Mail in the completed registry card (Pg. 2) or register online at www.swcorp.com/register.



PRODUCT REGISTRATION*

IMPORTANT: YOUR WARRANTY WILL NOT BE RECOGNIZED UNLESS THIS CARD IS FULLY COMPLETED AND RETURNED OR ONLINE REGISTRATION IS COMPLETED.

To ensure that your warranty is registered and confirmed please do one of the following:

1. **Register online at www.swcorp.com/register.** You will be asked to fill out the same information you would in the registration card. Registering online is fast, secure and ensures we receive your information.

2. **Complete, cut out and mail the registration card below.** By returning this registration card we confirm the date of purchase for your new product. This confirmation will allow us to process any warranty claims.

Mail the card to: 5701 NW 35 Avenue, Miami, FL 33142



Product Registration Card

Name Address

City State Zip

Phone Email.....

Date of Purchase..... Order or Purchase #..... SKU or Model #.....

Installer's Name Phone

I have read the Owner's Manual carefully and understand and agree that any installation, operation or maintenance of the product must be done strictly in accordance with instructions and guidelines contained in the owner's manual and installation guide.

Signature _____ Date _____

TL-MBSEL200WH

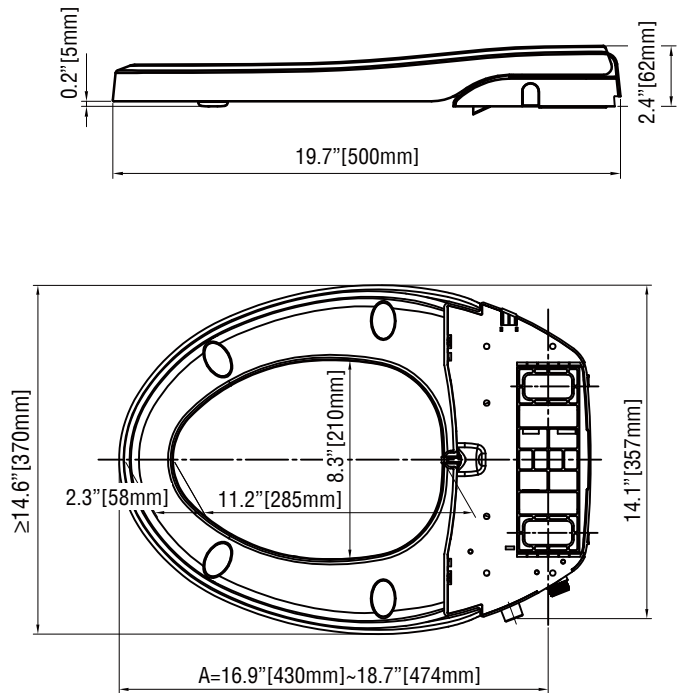
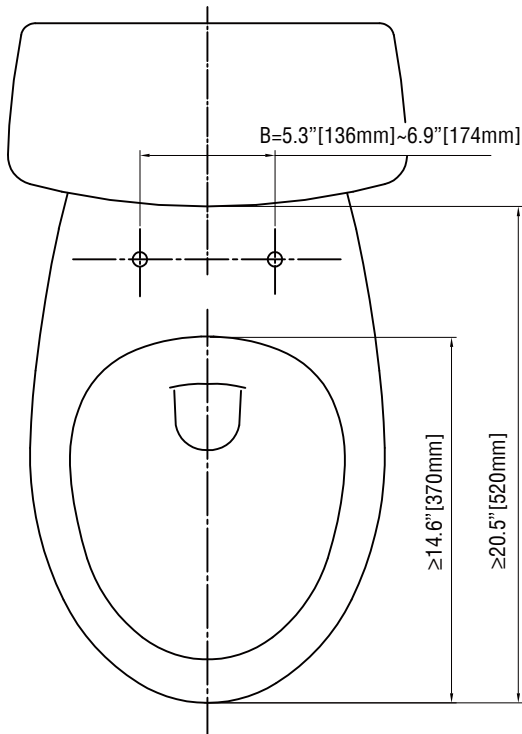

TL-MBSRN201WH

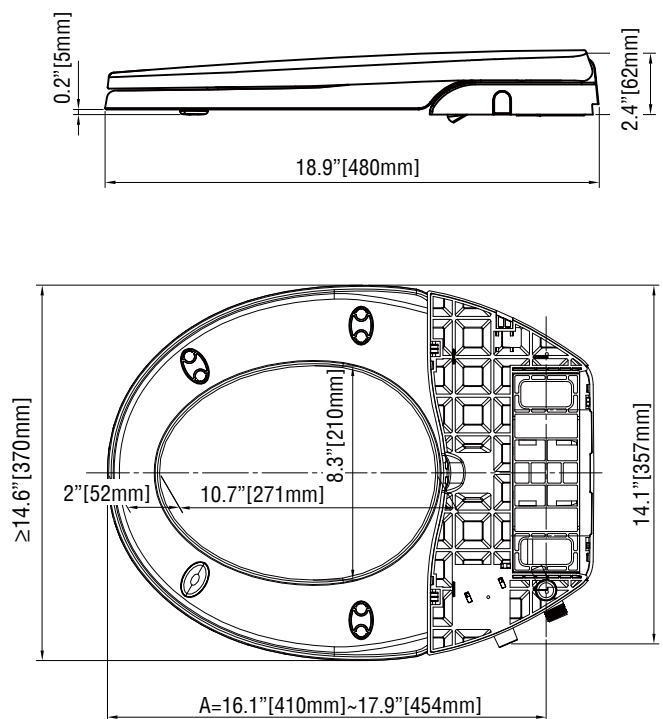
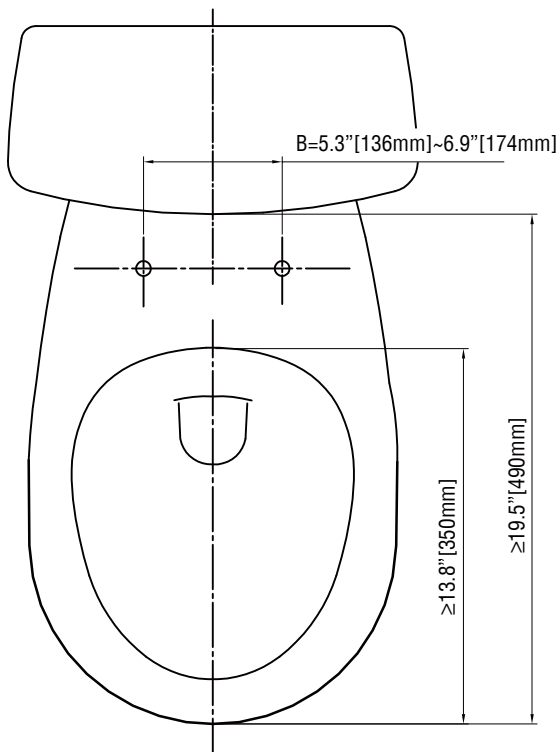

1 Part Name

■ General Product Drawing

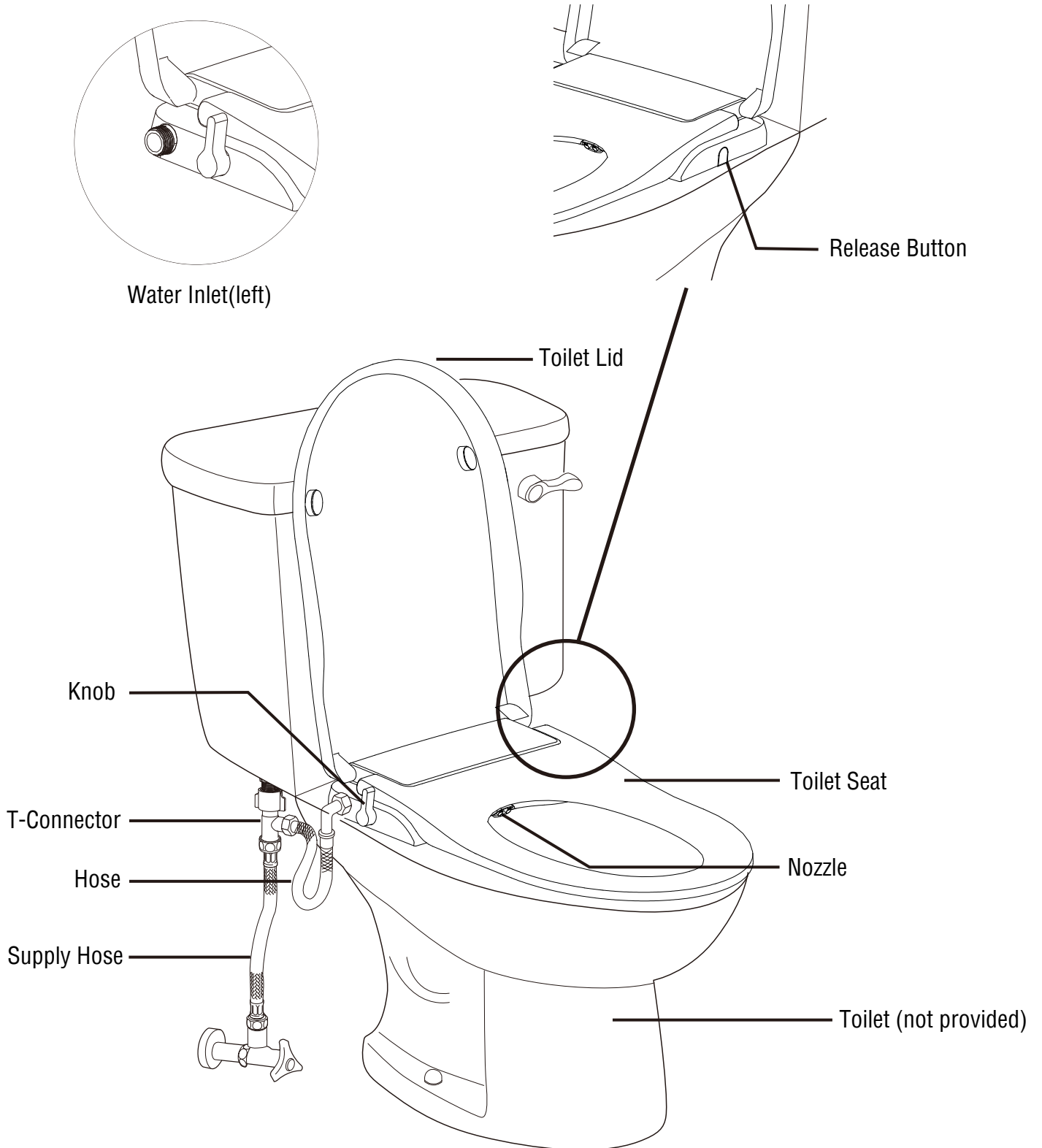

■ Parts

1.Toilet Seat

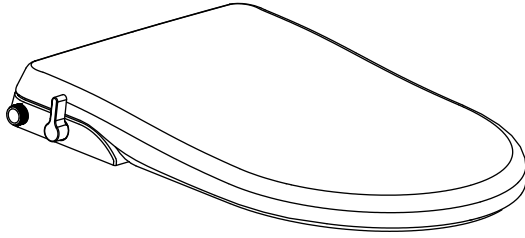

2.Template

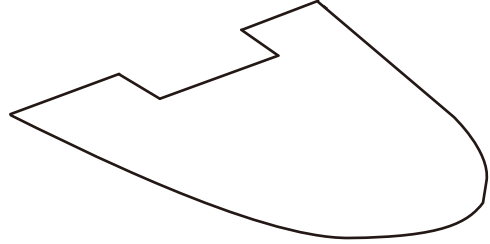

3.Fix Components

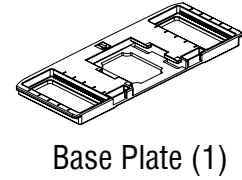
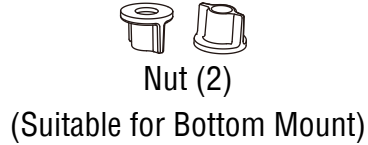
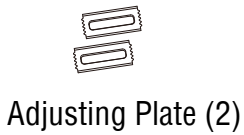
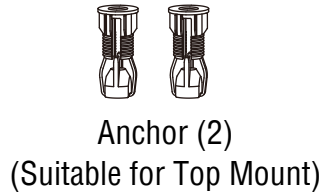
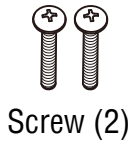

4.T-Connector

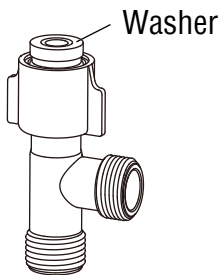

5.Hose

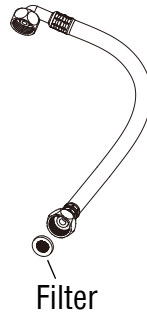

6.Installation Guide /User Manual

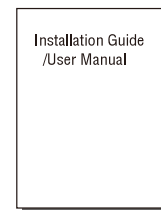

Note:There are two installation ways for this product. Use Anchor for the top mount installation and Nut for the bottom mount installation.

2 Installation

Please read and follow the installation and operation instructions carefully to ensure the seat's long life and reliable operation. FAILURE TO DO SO COULD CAUSE PROPERTY DAMAGE AND SERIOUS INJURY. Please keep this manual for future reference.

Installation Guideline

1. Water pressure range: 0.07-0.8MPa(10~116PSI).
2. Do not connect to a hot water supply. Providing water temperature above 104°F / 40°C will damage the product and void your warranty.

Installation Steps

1. Remove the old toilet seat.

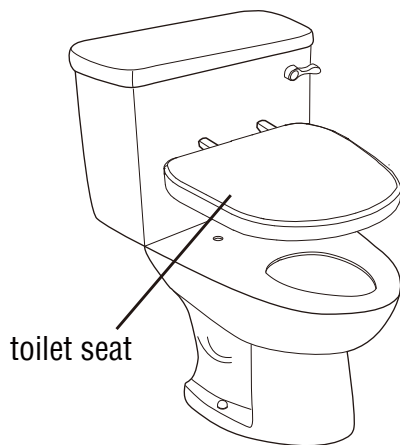

2A-1. Press the **Anchors** into the toilet bowl holes. If the anchor does not fit the bowl, proceed to Step 2B, otherwise, skip Step 2B and continue with Step 3.

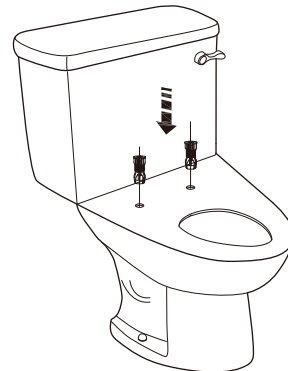

2A-2. Position and adjust the **Template** on the bowl. Place and align the **Base Plate** to the slotted area of the **Template** and then place the **Plate** and **Screws** as shown. Secure the **Base Plate** by tightening the **Screws**.

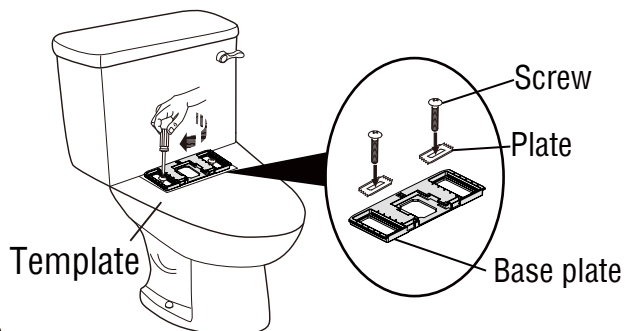

2B. Position and adjust the **Template** on the bowl. Place and align the **Base Plate** to the slotted area of the **Template** and then place the **Plate** and **Screws** as shown. Secure the **Base Plate** by tightening the **Nuts**.

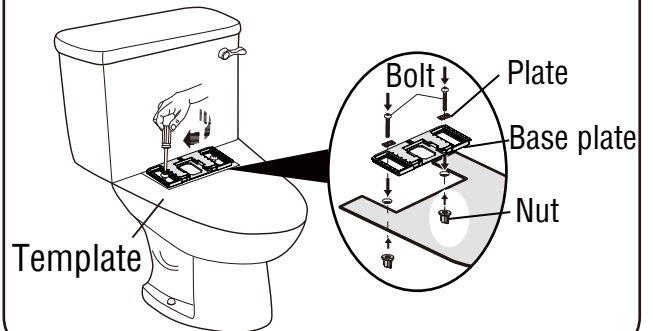

Installation Steps

3. Slide the **Toilet Seat** across the **Base Plate** until you hear a click sound to make sure the **Toilet Seat** is secured.



4. Turn off the supply stop, then disconnect the supply hose from the water tank. If you are using a rigid supply line you will need to purchase a flexible supply hose to install the toilet seat.

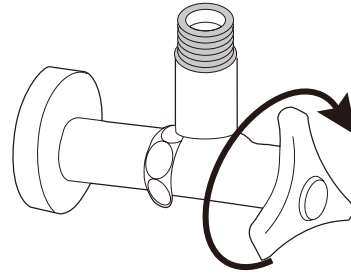

5. Install **T-Connector** to the **Inlet** and **Supply Hose** as shown. Connect the other point of **Supply Hose** to the supply stop if you're replacing the rigid supply with a new hose. Connect the included **Hose** on to the **T-Connector** and the toilet seat inlet with filter between the **T-Connector** and the **Hose**, washer on the other side.

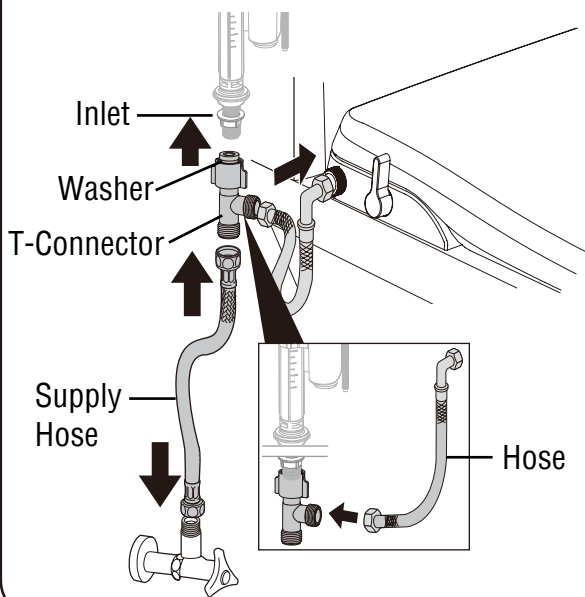

6. Make sure the Knob on the toilet seat is at the off position with lever pointing upward. Turn the supply stop back on and check connections at arrows for leaks. Retighten if necessary, but do not overtighten.

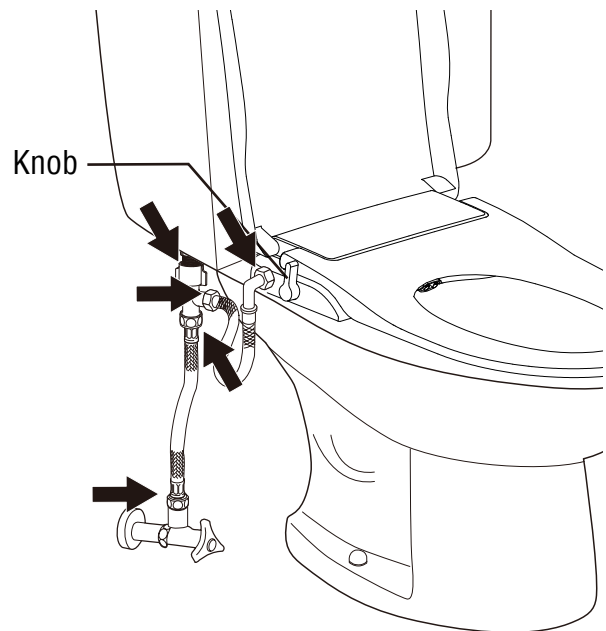

3 Operation Instruction

■ Back Wash Function

- Turn the knob forward from the vertical position as the figure shows. The nozzle extends.
- Continuing to turn the knob forward will increase the flow rate of the nozzle.
- Turn the knob backward to the vertical position to stop the cleaning and retract the nozzle.

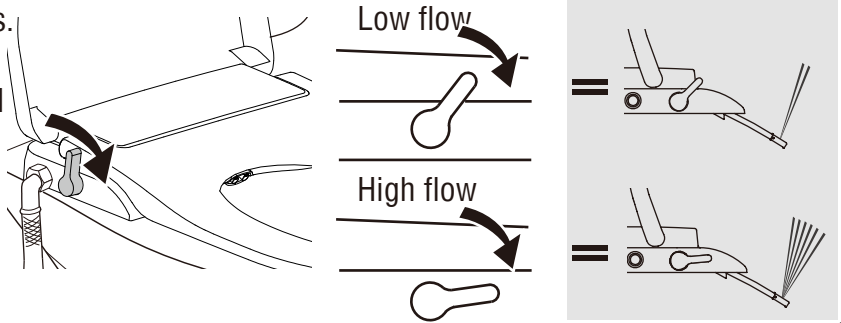

■ Front Wash Function

- Turn the knob backward from the vertical position as the figure shows. The nozzle extends.
- Continuing to turn the knob backward will increase the flow rate of the nozzle.
- Turn the knob forward to the vertical position to stop the cleaning and retract the nozzle.

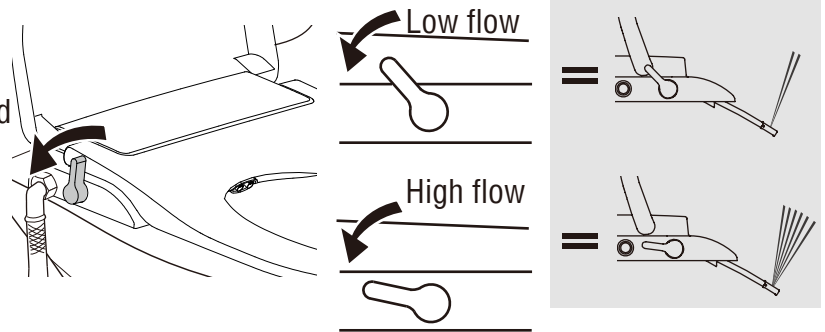

■ Stop cleaning and self-cleaning function (self-cleaning function is optional)

- Turn the knob to the vertical (90°) position to turn off the cleaning function.
- Before each use, the knob can be turned to the 25° gear and hold for a few seconds to clean the nozzle. When the toilet seat is connected with warm water, it can also play a role in emptying cold water.
- After each use, the nozzle can clean itself. If additional cleaning is needed for the nozzle, please turn the knob to the 25° gear and hold for a few seconds, then turn back to the vertical (90°) gear to turn off the self-cleaning function.

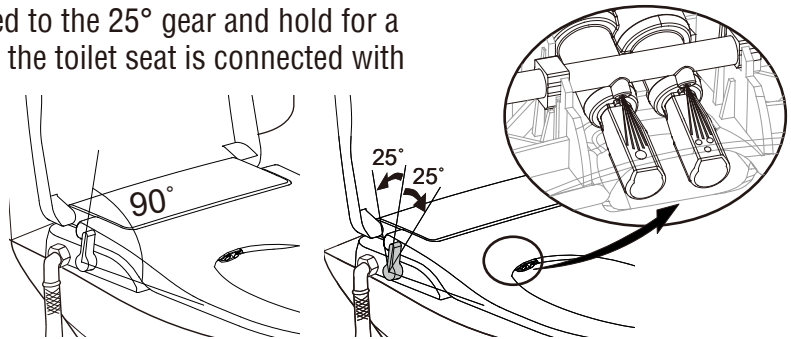

4 Cleaning and Maintenance

1. Clean the outside parts of the product.

Use a soft sponge or cloth with a non-abrasive cleaner to clean the product. Never use hydrogen chloride cleaner, diluent, benzene sandpaper, polishing agent, perfume, pesticide and other cleaning products.

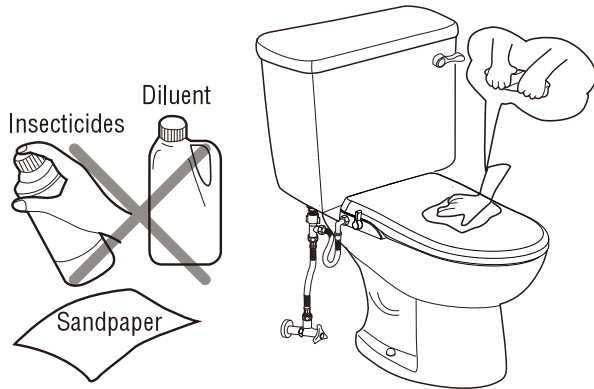

2. Clean the nozzle

Gently pull out the nozzle and use a soft toothbrush to clean the nozzle.

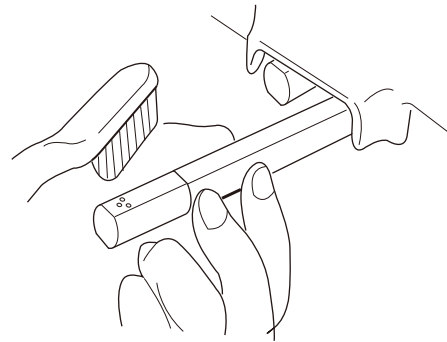

3. Clean Filter and Flow Restrictor.

(If you feel that the water flow is less than normal, please close the supply stop.)

- Remove the **Hose** and clean the **Filter** with a toothbrush.
- Remove the **Flow Restrictor** with a needle-nose plier and clean the sediment with a toothbrush.
- Reinstall the **Flow Restrictor**. Make sure it's installed in the correct orientation.
- Reinstall the **Hose**. Turn on the supply stop and check for leaks. Retighten if necessary, but do not overtighten.

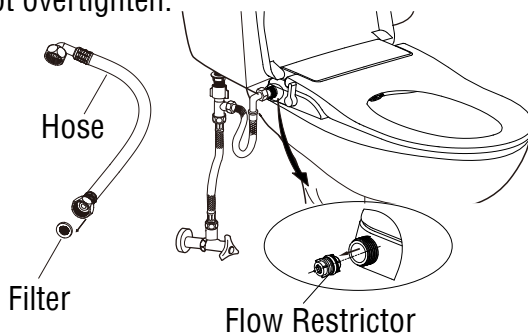

4. Remove the Toilet Seat.

Close the **Toilet Lid** of the product, press the **Release Button** and slide the seat forward as shown. This enables you to be able to clean more thoroughly around the toilet. If necessary, disconnect the **Hose** before you do this.



5 Trouble Shooting

Symptoms	Probable Causes	Recommended Action
Water is too low during Front/Back wash	1. Low water pressure of the unit	During Front/Back wash, turn the knob to a higher setting
	2. Low water pressure of water supply	Raise the water supply pressure higher than 0.07 MPa (10 psi)
No water comes out during Front/Back wash	1. Water shut-off valve is turned off	Turn on the water supply stop
	2. Filter of T-Connector is blocked	Clean the filter of T-Connector
	3. Filter of water inlet hose is blocked	Clean the filter of water inlet hose
	4. Nozzle head is blocked	Take off and clean the nozzle head
	5. External water pressure is low	Increase external water pressure
Water dropping from bowl when using the unit	External water pressure is too high	The maximum water pressure of the unit is 0.8 MPa (115 psi). If water supply pressure is higher than that, please use pressure reducing valve.

If the previous steps did not help to resolve your issue please contact us at 305-614-4070 or email us at art@swcorp.com.



Warning : It is highly recommended to not disassemble, repair or modify the unit. Doing so risks further damage to the product and voiding the warranty.

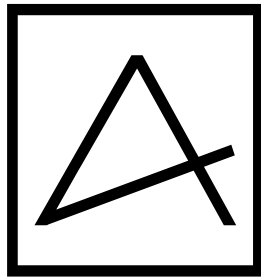

ANZZI®