

ANZZI™

WALL PANELS INSTALLATION & CARE GUIDE

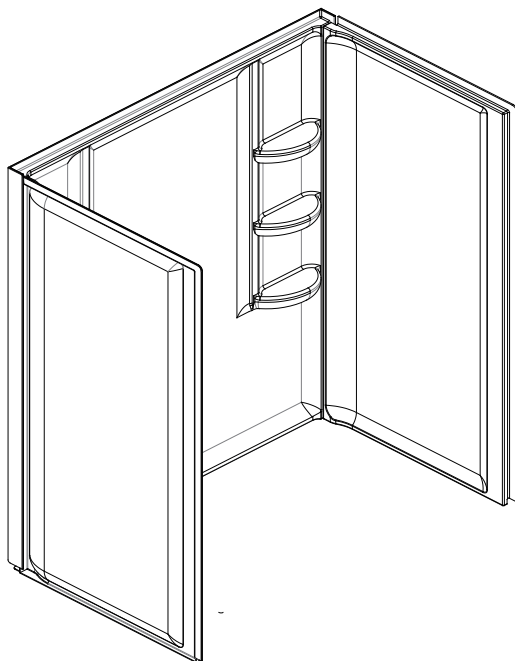

SW-AZ009WH
SW-AZ8076

Have questions? Visit us at www.ANZZI.com or call us at 1-844-44-ANZZI.

Preparation

1. Prior to installation, examine all boxes and packages for shipping damage and compare the piece count with your packing slip. After opening all boxes and packages, read this introduction carefully. Check that all of the needed parts are included in the package by checking off the components on the "Detailed Diagram of Shower Door Components". If the unit has been damaged, has a finishing defect, or has missing parts, please contact our customer support department within 5 business days of the delivery date. Please note that **we will not replace any damaged products or missing parts free of charge after 10 business days or if the product has been installed.**
2. Install all of the required plumbing and drainage before installing the Wall panels. **Use a competent and licensed (if required by local code) plumber for all plumbing installation.**
3. **Wall panels must be installed by a licensed plumber. Please note that you should consult your local building codes with questions on installation compliance standards. Building and plumbing codes may vary by location, and we are not responsible for code compliance standards for your project.**
4. Please insure that prior to the installation the installation wall is leveled and the stud is strong enough .

IMPORTANT NOTE: Dimensions provided are for reference only. You must measure the actual wall panels sizes before installation, this includes overall dimensions and stud / drywall / shower base or bath tub sizes.

THREE WALL PANELS SIZE

MODEL	SPECIFICATION	D1(in)	D2(in)	W(in)	H(in)	F(in)
SW-AZ009WH	36"X60"X36"X74"	36"	36"	60"	74"	1.5"
SW-AZ008WH	36"X60"X36"X60"	36"	36"	60"	60"	1.5"

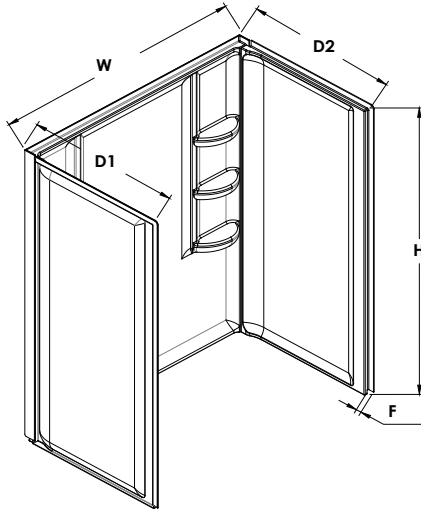

TWO WALL PANELS SIZE

MODEL	SPECIFICATION	D(in)	W(in)	H(in)	F(in)	
SW-AZ005WH	60"X36"X74"	36"	60"	74"	1.5"	

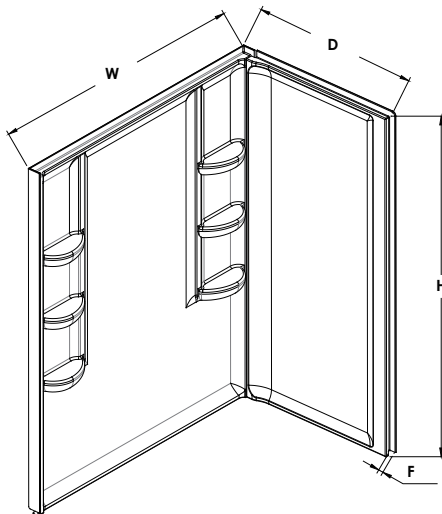

Wall Panels Installation-Preparation

1. Check the wall panels and the screw .

See Fig. 1 for details

2. Make sure the stud and drywall have finished ,the shower base or bath tub is ok for build the wall panels,place silicone on the drywall first.

See Fig. 2 for details

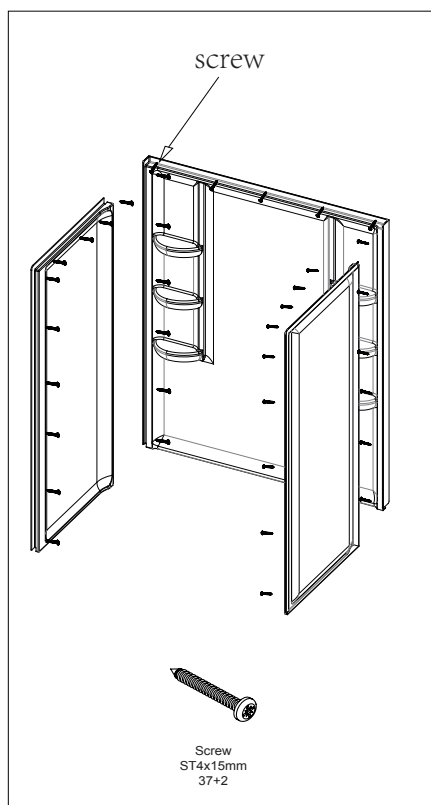

Fig. 1

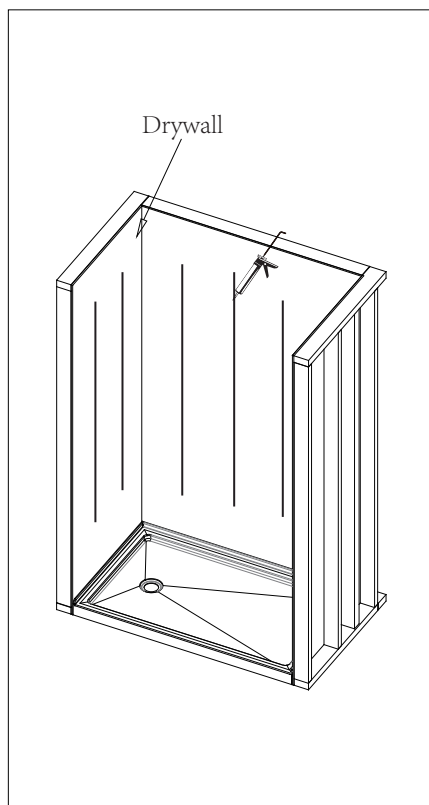

Fig. 2

3. Place the center wall panels on the drywall.

See Fig. 3 for details

4. Place the side wall panels (right and left) .

See Fig. 4 for details

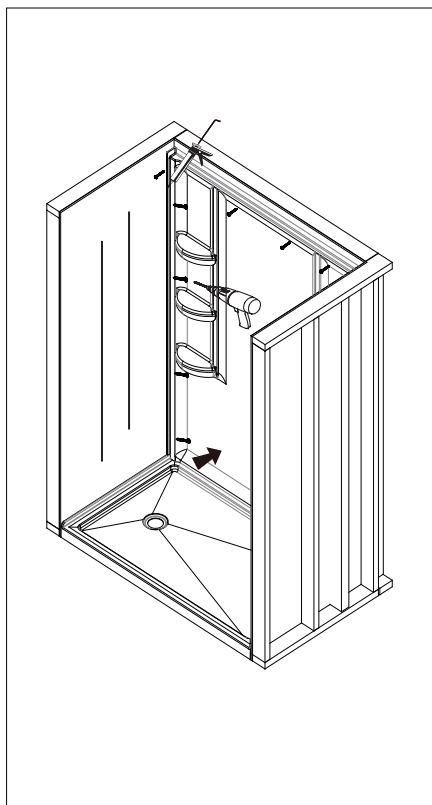

Fig. 3

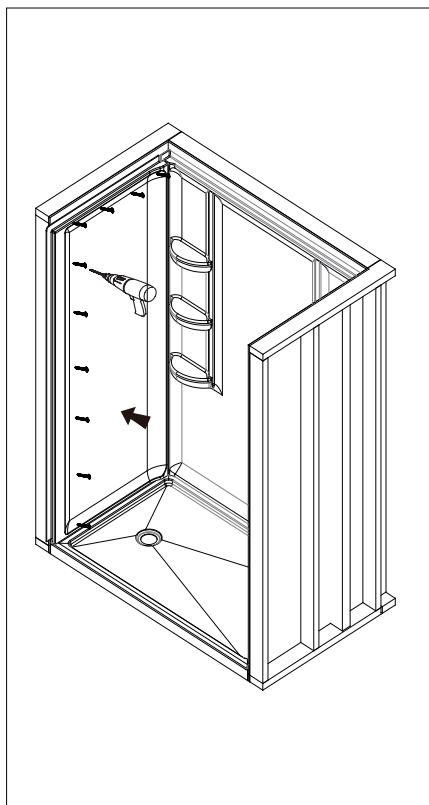

Fig. 4

5. Refer to the section for finished install .

See Fig. 5 for details

6. Use silicone to fill the gap between wall panels and base(bath tub), also the gap between centre panel and side panel. use studs to support the wall panels for 24 hours.

See Fig. 6 for details

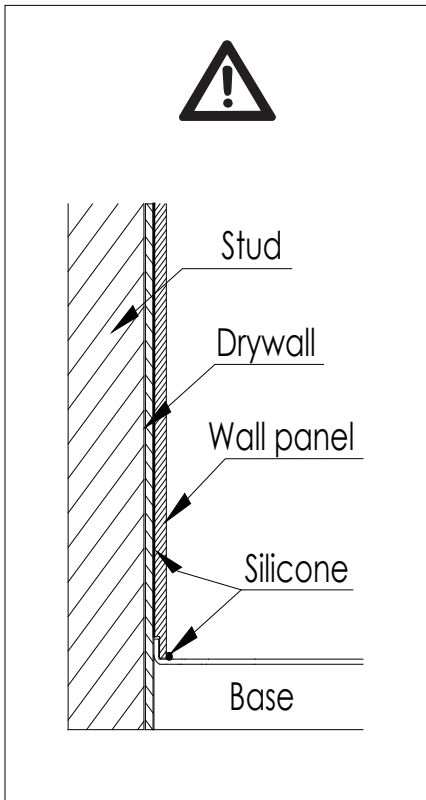

Fig. 5

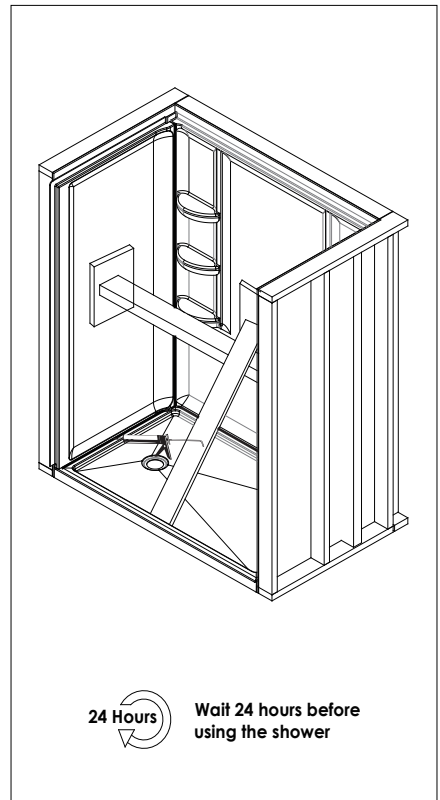

Fig. 6