

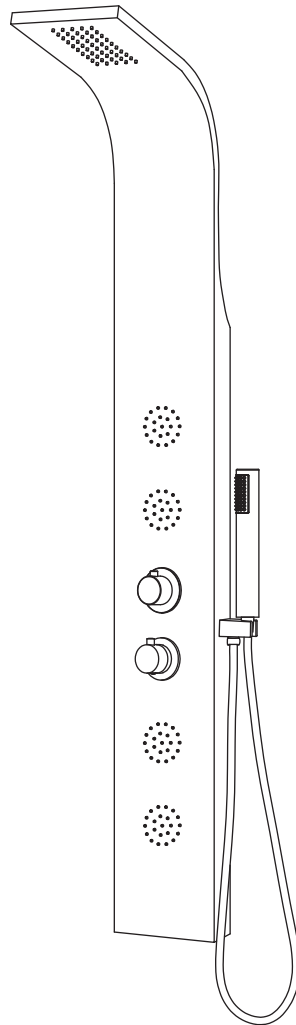

ANZZI™

---

PRAIRE  
INSTALL GUIDE



Model#  
SP-AZ040

---

PERFECTION IS OUR TRADITION™

---

## TABLE OF CONTENTS

|                    |            |
|--------------------|------------|
| Parts List         | Pg. 1      |
| Before You Start   | Pg. 2      |
| Spec Drawing       | Pg. 3      |
| Installation       | Pg. 4      |
| Care & Maintenance | Pg. 10     |
| Warranty           | Pg. 11     |
| Registration       | Final Page |

### YOUR REVIEWS MATTER!



The ANZZI™ Family thanks you for your purchase and hopes you enjoy your very own ANZZI product for years to come! In the meantime let us know about your experience? We would love to hear your thoughts from the packaging to the quality and function of the product.

Leave a review on [www.ANZZI.com/reviews](http://www.ANZZI.com/reviews) and let everyone know how satisfied you are with ANZZI!

Also, we humbly request submitting as many pictures as possible along with your review. Millions of shoppers will want to know about your experience with our products. Don't just tell but show, too!

---

For more information please call 1-844-44-ANZZI  
or email us at [support@ANZZI.com](mailto:support@ANZZI.com)

# PARTS LIST

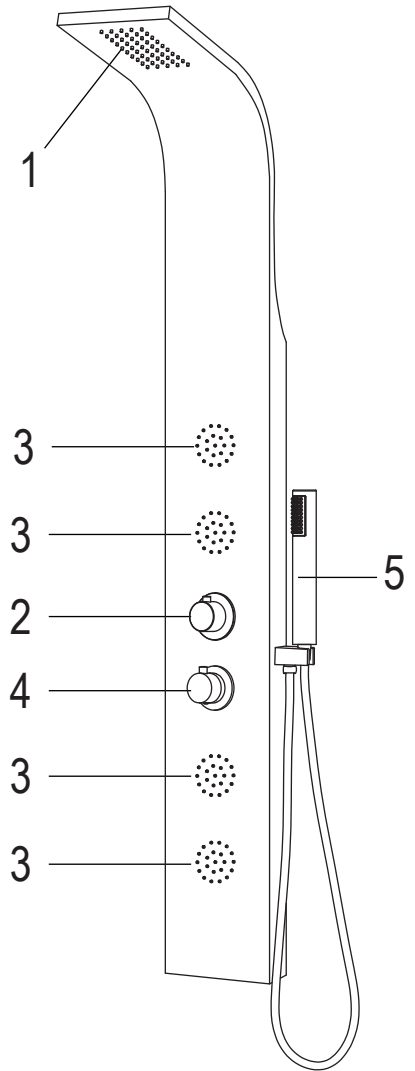
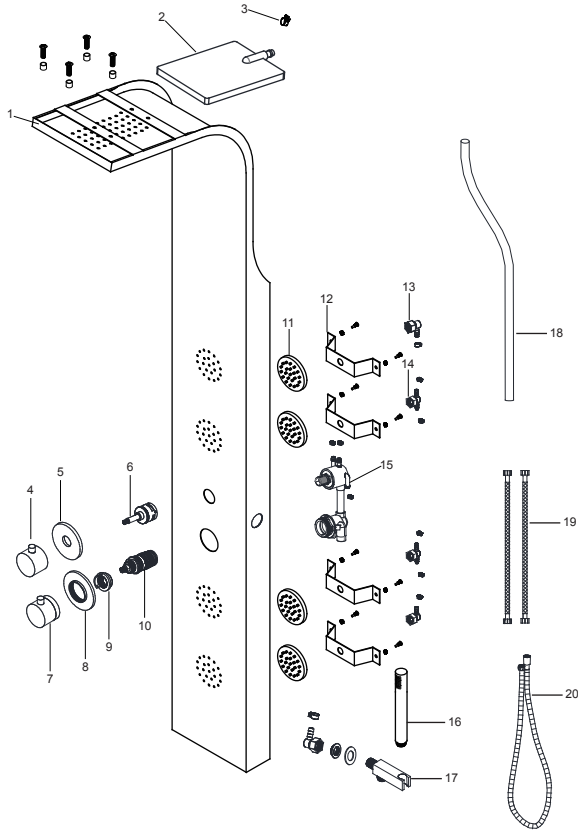

| Component no. | Component              | Material |
|---------------|------------------------|----------|
| 1             | body                   | s/s      |
| 2             | head shower            | ABS      |
| 3             | clip                   | s/s      |
| 4             | knob                   | zinc     |
| 5             | knob plate cover       | brass    |
| 6             | function cartridge     | ABS      |
| 7             | handle                 | zinc     |
| 8             | handle plate cover     | brass    |
| 9             | valve cap              | ABS      |
| 10            | thermostatic cartridge | ABS      |
| 11            | body jets              | brass    |
| 12            | fixing bar             | s/s      |
| 13            | one way joint          | ABS      |
| 14            | two way joint          | ABS      |
| 15            | faucet                 | brass    |
| 16            | hand shower            | ABS      |
| 17            | hand shower holder     | ABS      |
| 18            | pvc hose               | PVC      |
| 19            | braided hose           | s/s      |
| 20            | flexible hose          | s/s      |

1. Shower Head
2. Diverter
3. Body Jets
4. Mixer
5. Hand Shower



ASME A112.18.1/CSA B125.1

PERFECTION IS OUR TRADITION™

---

# BEFORE YOU START

## Recommended Items

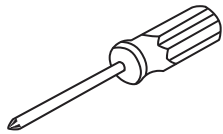

Screwdriver

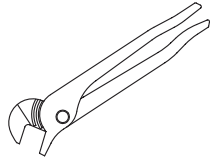

Channel Locks



Goggles

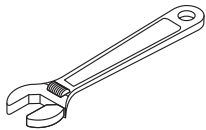

Adjustable Wrench



Teflon tape

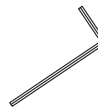

Allen key

ATTENTION: Please read all instructions thoroughly including all warnings, attentions and notes before beginning installation.

For any questions or concerns contact our dedicated technical support team at 1-844-44-ANZZI.

---

PERFECTION IS OUR TRADITION™

---

# SPEC DRAWING

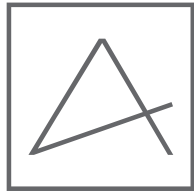

ANZZI™

Perfection is our Tradition™

## PRAIRE

SP-AZ040

Material: Stainless Steel  
Finish: Brushed  
Handles: 2  
Jets: 4  
Shower: 2.99" x 6.535"  
Sprayer: 60" reach  
Weight: 16.94 lbs  
Height: 62.99"  
Supply: 1/2" connections  
Flow: 2.5 gpm

### Features

Heavy Rain™ Showerhead  
Acu-Stream™ high pressure body jets  
Euro-Grip™ hand held sprayer  
Rhino Alloy™ certified materials

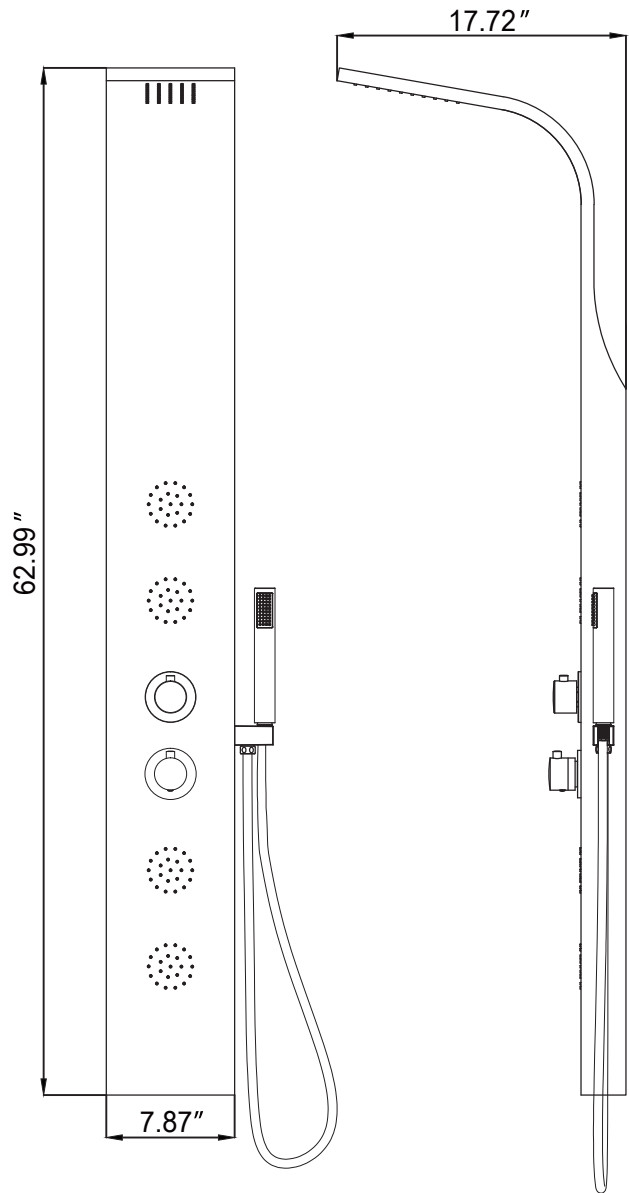

---

PERFECTION IS OUR TRADITION™

---

# INSTALLATION (SETUP)

Figure A

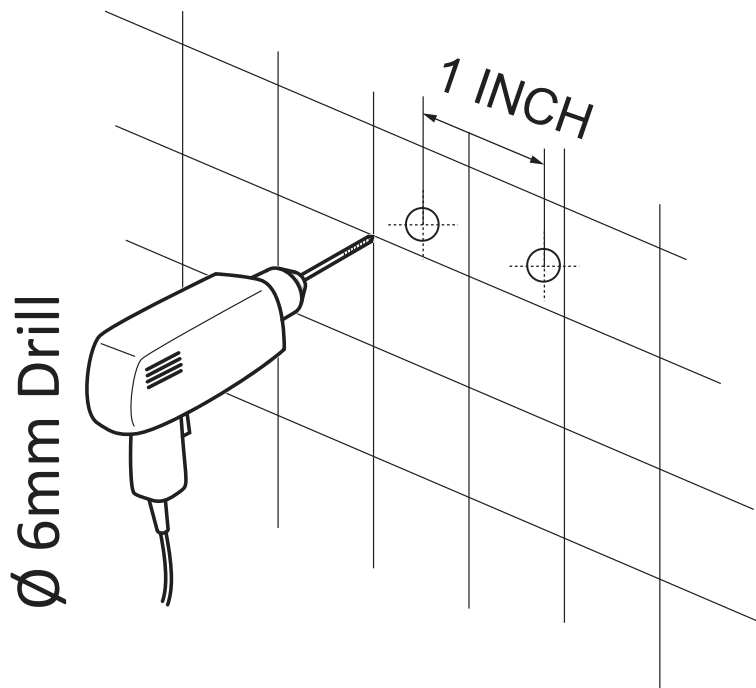

**IMPORTANT** Before drilling any holes for the shower panel brackets, ensure there are no hidden cables or pipelines aligned with the desired drilling position.

**Step A** Drill the two holes for the top bracket 1" apart at the desired height.

**Step A.2** Drill the two holes for the bottom bracket 1" apart at approximately 45" below the top bracket.

---

# INSTALLATION (SETUP)

Figure B



Figure C



**Step B** Insert the wall anchors into the pre-drilled holes as shown in Figure B.

**Step C** Place the shower panel brackets aligned with the drilled holes and using a Philips screwdriver tighten the screws to secure the brackets.

---

PERFECTION IS OUR TRADITION™

---

# INSTALLATION (HANDSHOWER)

Figure 1

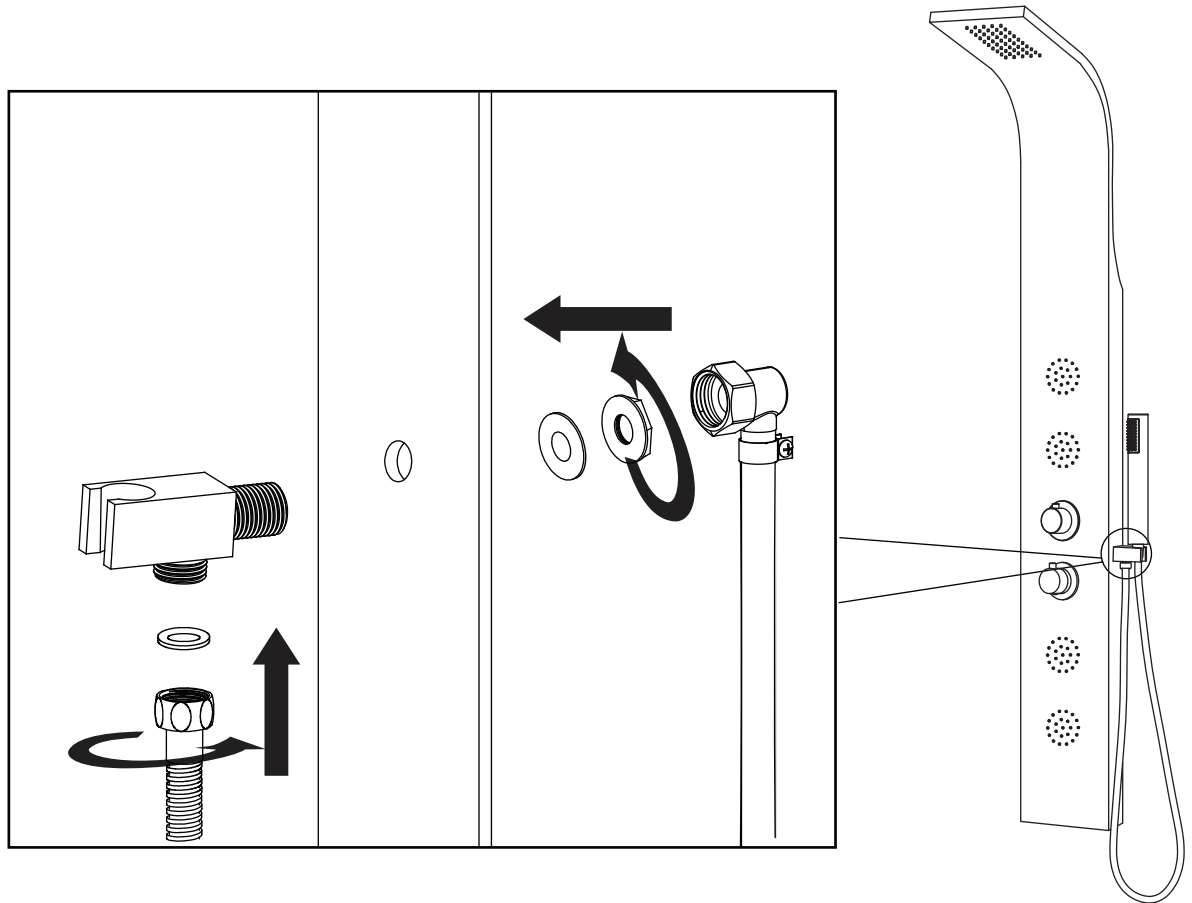

- Step 1A** Insert the shower wand holder through the pre-drilled hole on the shower panel.
- Step 1B** Install the water supply hose for the shower wand onto the holder, as shown.
- Step 1C** Make sure all O-rings are inserted to prevent leakage.
- Step 1D** Once the shower panel is fully installed and hung on the bracket, you can install the shower wand hose to the holder connection.



---

# INSTALLATION (HANDSHOWER)

Figure 2

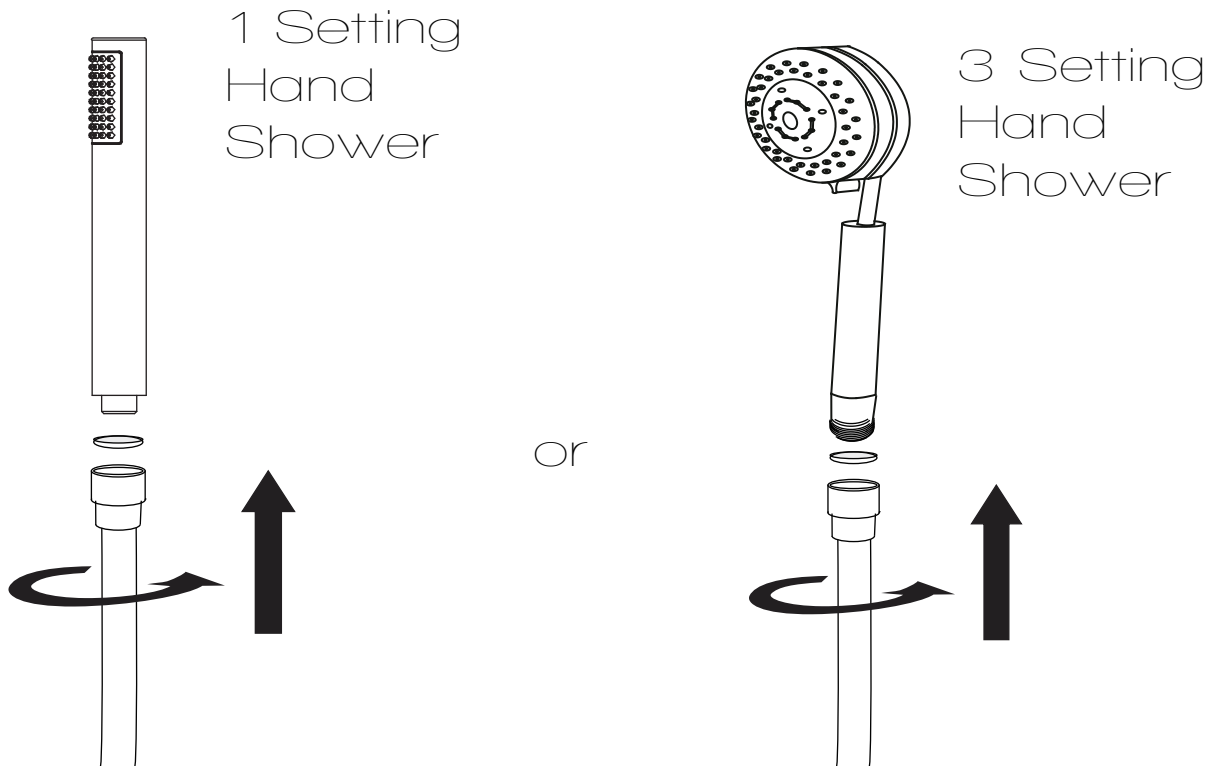

**Step 2A** Finally, install the shower wand to the hose, as shown.

---

# INSTALLATION (WALL MOUNTING)

Figure 4

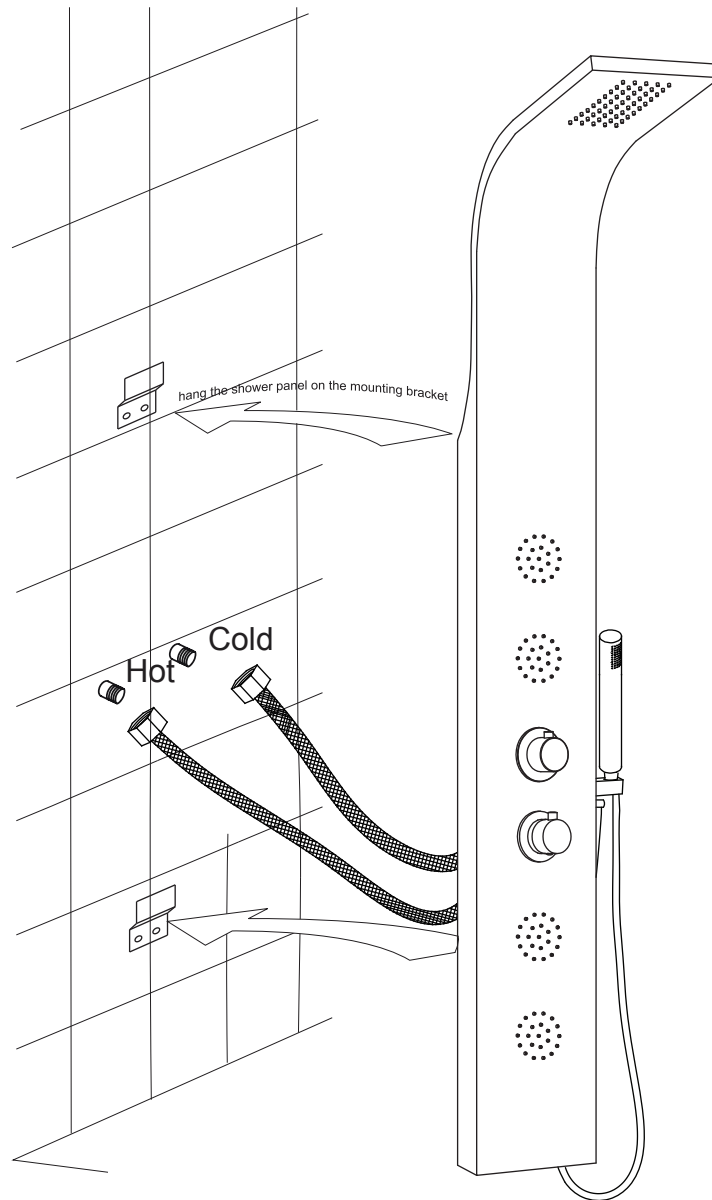

**Step 4A** Screw the cold and hot water hoses from the shower panel to the supply lines in the wall.

**Step 4B** Carefully hang the shower panel on the secured mounting brackets as shown in Figure 4.

---

PERFECTION IS OUR TRADITION™

---

## CARE AND MAINTENANCE

ANZZI™ products are crafted with superior quality standards and workmanship and are engineered to stand the test of time. However, that does not mean the product can be neglected and will need some care and cleaning.

It is recommended to use regular soap and hot water along with a non-abrasive cloth or sponge to regularly clean the product. This avoids any nasty build up or deposits which would be tougher to remove.

If you feel the use of stronger cleaning solutions or chemicals is necessary always test the cleaning solution or chemical on an inconspicuous area before applying to the entire surface.

Wipe all surfaces clean and rinse completely with water immediately after applying cleaner. Rinse and dry any overspray that lands on nearby surfaces.

DO NOT ALLOW THE CLEANER TO SOAK.

Following these simple principles will ensure you ANZZI™ product will remain as lustrous and stunning as the day it was first received. ENJOY!

Sincerely,

La Familia ANZZI™

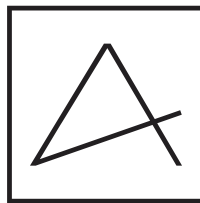

ANZZI™

Perfection is our Tradition™

---

For more information visit us at [www.ANZZI.com](http://www.ANZZI.com)

---

## LIMITED LIFETIME WARRANTY

ANZZI™ products are manufactured with superior quality standards and workmanship and are backed by our limited lifetime warranty. ANZZI™ products are warranted to the original consumer purchaser to be free of defects in materials or workmanship. We will replace FREE OF CHARGE\* any product or parts that proves defective. Simply call 1-844-44-ANZZI (1-844-442-6994) to submit a warranty claim and request an RMA. Proof of purchase (original sales receipt) from the original consumer purchaser must be made available for all ANZZI™ warranty claims.

This warranty excludes incidental/inconsequential damages and failures due to misuse, abuse or normal wear and tear. This warranty excludes all industrial, commercial & business usage, whose purchasers are hereby, extended a five year limited warranty from the date of purchase, with all other terms of this warranty applying except the duration of warranty.

Some states and provinces do not allow the exclusion or limitation of incidental or consequential damages, so the above limitations may not apply to you. This warranty gives you specific legal rights and you may also have other rights that vary from state to state and province to province. Please contact 1-844-44-ANZZI (1-844-442-6994) or visit [www.ANZZI.com/Warranty](http://www.ANZZI.com/Warranty) for more details.

Sincerely,

La Familia ANZZI™

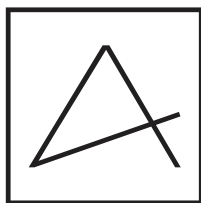

ANZZI™

Perfection is our Tradition™

---

\*Shipping and handling fees are not covered under the ANZZI™ Warranty.

This warranty is in effect as of January, 2016. This warranty supersedes all previous warranties and/or claims both stated and implied. This warranty is subject to change without notice.





PRODUCT AND WARRANTY REGISTRATION

To register your product and activate your Limited Lifetime Warranty contact us at 1-844-44-ANZZI or email us at support@ANZZI.com. Or, if preferable, fill out the form below then scan/fax/mail us a copy.

Email: support@ANZZI.com

Fax: 1-866-560-1060

Mail: ANZZI™  
5701 NW 35th Ave.  
Miami, FL 33142

In need of replacement parts?  
Visit [www.SpaWorldParts.com](http://www.SpaWorldParts.com)

**ANZZI™** Product Registration Card

Name.....

Address .....

City ..... State ..... Zip .....

Phone .....

Email.....

Date of Purchase..... Dealer .....

Address .....

Installed by .....

Address ..... State .....

Phone ..... State..... Zip.....

Email.....

I have read the ANZZI™ Owner's Manual carefully and understand and agree that any installation, operation or maintenance of the product must be done strictly in accordance with instructions and guidelines contained in the ANZZI™ owner's manual and installation guide.

Signature \_\_\_\_\_ Date \_\_\_\_\_

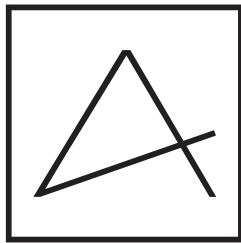

ANZZI™

---

Perfection is our Tradition™