

6279.000 Shown

**MODEL NUMBER:**

- 6279.000 Top-Mount Kitchen Faucet**  
Swivel spout. Color-matched side spray. Less handles.
- 6270.000 Top-Mount Kitchen Faucet**  
Swivel spout. Less spray. Less handles.

**Handles must be ordered separately.**

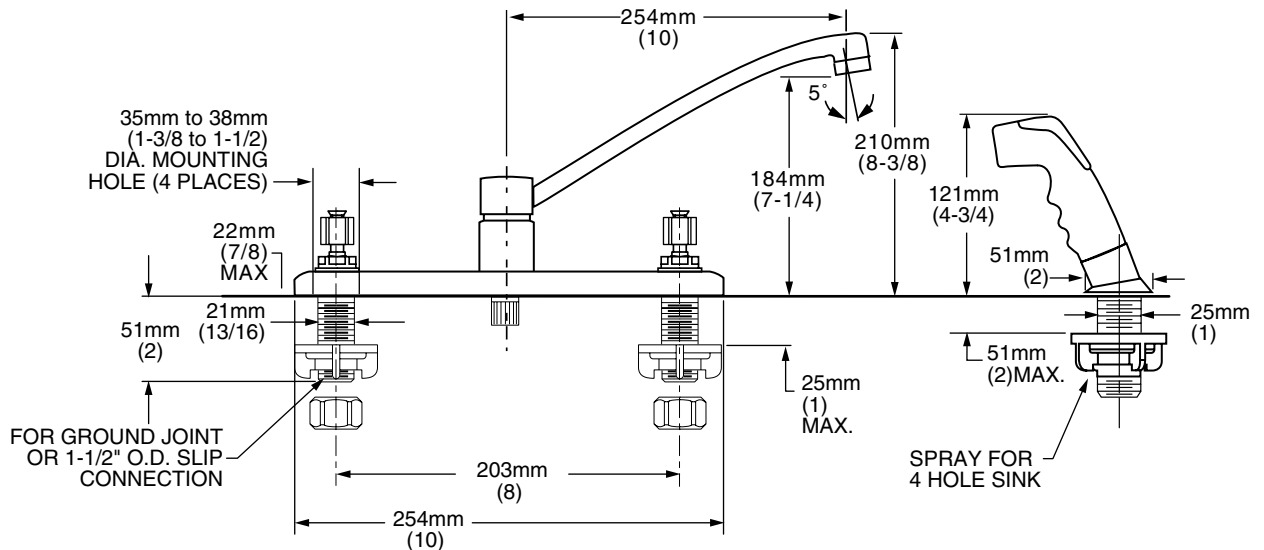

**GENERAL DESCRIPTION:**

Durable cast brass construction. Amarisil 1/4 turn washerless ceramic disc valve cartridges - reversible for use with either lever or round handles. One-half inch male inlet shanks with brass coupling nuts. 10" (254mm) long brass swing spout. Brass escutcheon plate (escutcheon size 10" L x 2-1/8" W ). 2.2gpm/8.3L/min. maximum flow rate.

**PRODUCT FEATURES:**

- Brass Construction:** Durable - Excellent in high use applications. Ideal for prolonged contact with water.
- Ceramic Disc Valve Cartridges:** Assures a lifetime of drip-free performance.
- Low Lead:** Meets NSF Standard 61/Section 9 & Prop 65 lead requirements.
- Wide Selection of Handle Styles:** Full range of interchangeable handle styles.

**SUGGESTED SPECIFICATION:**

Two handle top-mount kitchen faucet shall feature cast brass construction with all brass coupling nuts. Shall also feature 1/4 turn washerless ceramic disc valve cartridges that are reversible for use with round or lever handles. Fitting shall be American Standard Model # 627\_.000.\_\_\_\_ and handle kit # 0000.\_\_\_\_.

**CODES AND STANDARDS**

These products meet or exceed the following codes and standards:

- ASME A112.18.1**
- CSA B 125**
- NSF 61/Section 9**

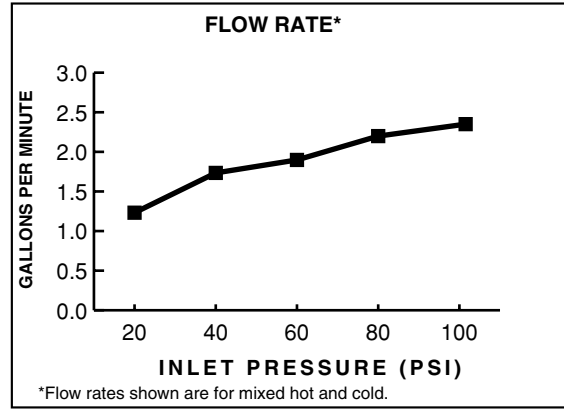





Product Number	Description	Finish
		Polished Chrome
		002
6279.000	Kitchen faucet. Color matched side spray. Less handles.	
6270.000	Kitchen faucet. Less spray. Less handles.	

**Handles must be ordered separately.**

To order **Less Handles** - Specify: 4 digit style number followed by three zeros and 3 digit finish number. Example 6279.000.002 = Kitchen faucet with hand spray in Polished Chrome finish.

The above fittings will accept the following Amarilis-Series handles.

	
Wrist Blade	Lever
172H 172V	142H 142V
	

 Meets the American Disabilities Act Guidelines and **ANSI A117.1** Requirements for the physically challenged.