

**MODEL NUMBER:**

**TRIM KIT:**

- T45740 Two-Handle Thermostat Trim Kit**  
With separate volume control. LESS Valve.

**ROUGH VALVES:**

**TEMPERATURE & ON/OFF VOLUME CONTROL ONLY**

- R520 Rough Valve Body only**  
1/2" NPT inlets/outlets. With separate volume control. LESS Trim.
- R540 Rough Valve Body only**  
3/4" NPT inlets/outlets. With separate volume control. LESS Trim.

**TEMPERATURE & ON/OFF VOLUME CONTROL & BUILT-IN DIVERTER**

- R522 Rough Valve Body only**  
1/2" NPT inlets/outlets. With separate volume control and built-in 2-way diverter. LESS trim.
- R523 Rough Valve Body only**  
1/2" NPT inlets/outlets. With separate volume control and built-in 3-way diverter. LESS trim.

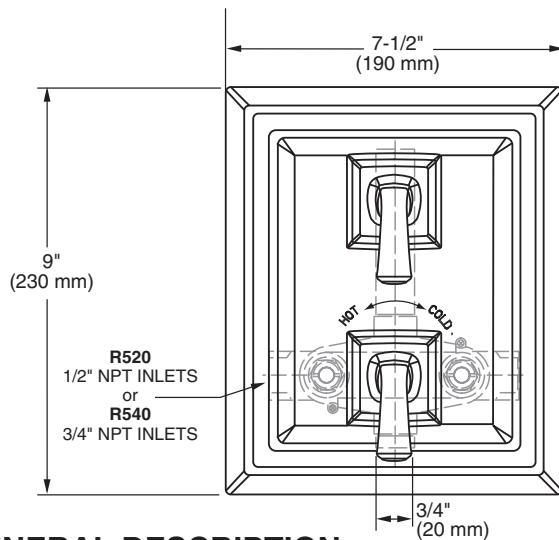

NOTE: FITTING MUST BE INSTALLED WITH VOLUME CONTROL ON TOP.

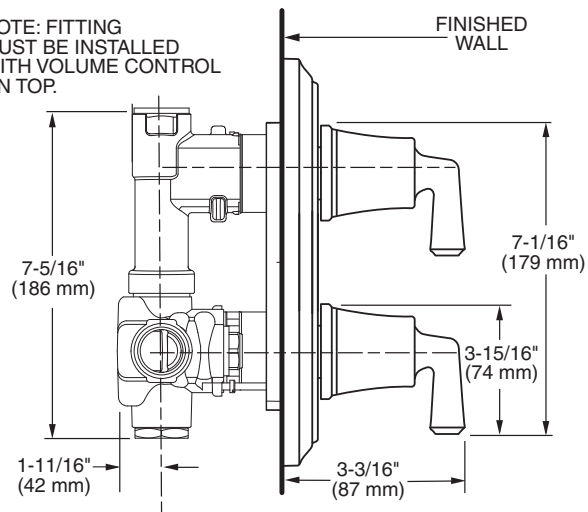

**GENERAL DESCRIPTION:**

Cast brass valve body. The single unit contains two handles, the bottom lever handle sets the desired temperature and the top handle functions as an on/off, volume control. The temperature is maintained by a wax element moving a shuttle valve between hot and cold. The volume is controlled by twin ceramic disc valve cartridges. Ceratherm includes Hot Limit Safety Stop. Maximum temperature limit is 112°F. Escutcheon plate is stamped brass. Available with 1/2" or 3/4" NPT inlets and outlets. The valve has a high flow rate, ideal for multiple outlet installations.



ADA COMPLIANT

**PRODUCT FEATURES:**

- Brass Casting:** Highest quality faucet material for durability & long life.
- Wax Thermostatic Unit:** Permits shuttle valve to move between the hot and cold seat to maintain the pre-selected constant water temperature.
- Back to Back Capable:** Hot and cold can be reversed.
- Spring-Loaded Check Valves:** When the hot and cold water enters the fitting, both supplies pass through the spring-loaded check valves to prevent cross flow of hot and cold water.
- Integrated Stop Valves:** Ensure easy cleaning and servicing.
- Adjustable Hot Limit Safety Stop:** Limits the amount of hot water allowed to mix with cold. Reduces the risk of accidental scalding. Maximum water temperature limit may be reduced to 104 or 109 degrees Fahrenheit.

**SUGGESTED SPECIFICATION**

Two-handle Thermostat shall feature a cast brass valve body. Thermostat shall be a wax element shuttle valve. Shall also feature ceramic disc valving, 1/2" NPT or 3/4" NPT inlets and outlets. Fitting shall be American Standard Model # T45740.\_\_\_\_ (Trim Kit) and R52\_ or R540 (Rough Valve).

**CODES AND STANDARDS**

These products meet or exceed the following codes and standards:

- ASSE 1016
- ASME A112.18.1
- CSA B125.1

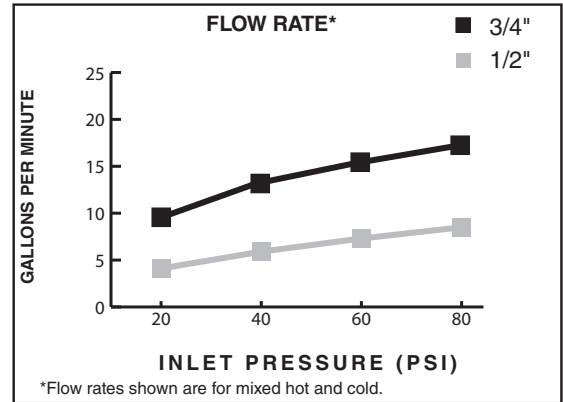

TRIM KITS **	Product Number	Description	Finish Options			
			Polished Chrome	PVD Brushed Nickel	Polished Nickel	Legacy Bronze
			002	295	013	278
T455740*	Two-handle Thermostat Trim Kit with separate volume control.					

ROUGH VALVE BODIES	Product Number	Description
	R520*	Rough Valve Body less trim - 1/2" NPT Inlets/Outlets. With separate volume control only. LESS trim.
	R540*	Rough Valve Body less trim - 3/4" NPT Inlets/Outlets. With separate volume control only. LESS trim.
	R522	Rough Valve Body less trim - 1/2" NPT Inlets/Outlets. With separate volume control and built-in 2-way diverter. LESS trim.
	R523	Rough Valve Body less trim - 1/2" NPT Inlets/Outlets. With separate volume control and built-in 3-way diverter. LESS trim.

**\*NOTE:** When used as a Bath/Shower a separate diverter valve is required (such as R420 or R430).  
**Requires twin ell (must be ordered separately) for use with diverter spouts.**

Meets the American Disabilities Act Guidelines and **ANSI A117.1** Requirements for the physically challenged.

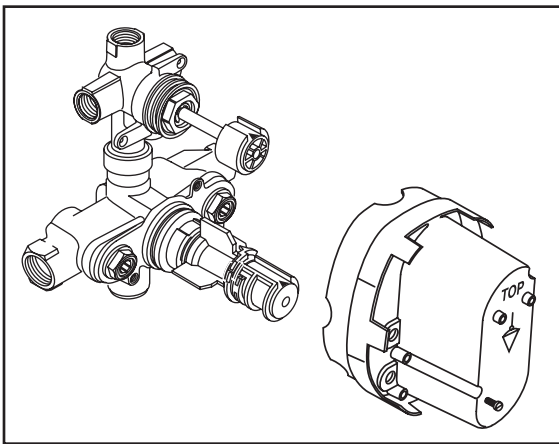

R523 Shown

**MODEL NUMBER:**

- R522 Rough Valve Body only**  
 1/2" NPT inlets/outlets. With built-in 2-way diverter  
 LESS Trim.
- R523 Rough Valve Body only**  
 1/2" NPT inlets/outlets. With built-in 3-way diverter  
 LESS trim

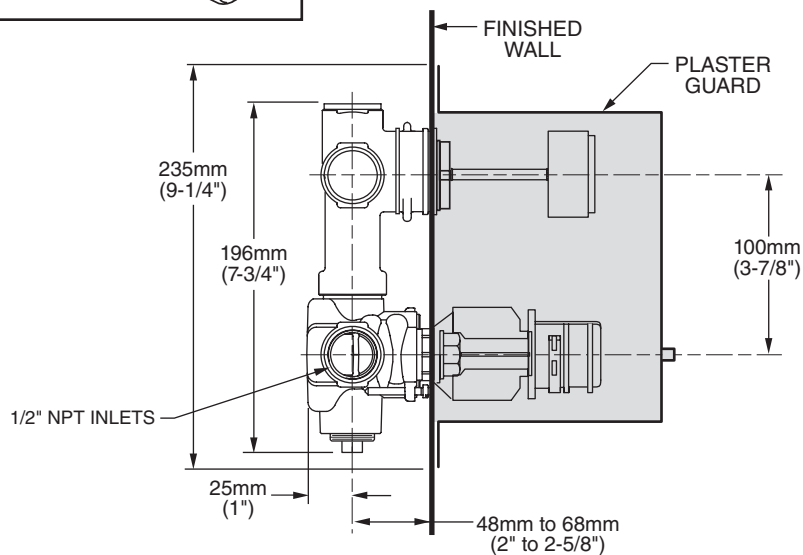

**GENERAL DESCRIPTION:**

Cast brass valve body. The single unit contains two handles, the bottom handle sets the desired temperature and the metal top handle controls on/off, volume and diverter functions. The temperature is maintained by a wax element moving a shuttle valve between hot and cold. The volume is controlled by twin ceramic disc valve cartridges. Ceratherm includes Hot Limit Safety Stop. Maximum temperature limit is 112°F. Available with 2-way or 3-way diverter. 1/2" NPT inlets and outlets.

**PRODUCT FEATURES:**

- Brass Casting:** Highest quality faucet material for durability & long life.
- Built-in Diverter:** Allows user to choose between 2 or 3 separate shower outlets.
- Wax Thermostatic Unit:** Permits shuttle valve to move between the hot and cold seats to maintain the pre-selected constant water temperature.
- Back to Back Capable:** Hot and cold can be reversed.
- Spring-Loaded Check Valves:** When the hot and cold water enters the fitting, both supplies pass through the spring-loaded check valves to prevent cross flow of hot and cold water.
- Integrated Stop Valves:** Ensure easy cleaning and servicing.
- Adjustable Hot Limit Safety Stop:** Limits the amount of hot water allowed to mix with cold. Reduces the risk of accidental scalding. Maximum water temperature limit may be reduced to 104 or 109 degrees Fahrenheit.

**SUGGESTED SPECIFICATION:**

Two handle thermostat shall feature a cast brass valve body. Shall feature built-in diverter. Thermostat shall be a wax element shuttle valve. Shall also feature ceramic disc valving, 1/2" NPT inlets and outlets. Fitting shall be American Standard Model # R52\_.

### CODES AND STANDARDS

These products meet or exceed the following codes and standards:

- ASSE 1016
- ASME A112.18.1
- CSA B125.1



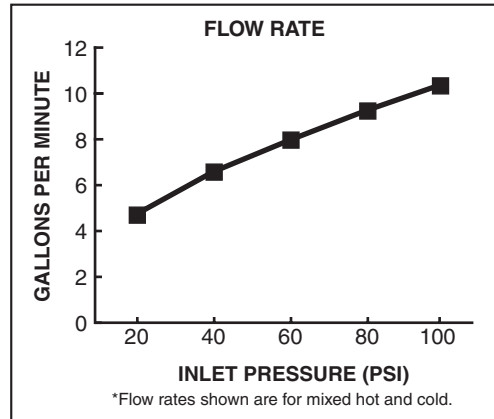





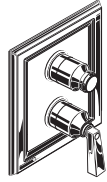

 Meets the American Disabilities Act Guidelines and **ANSI A117.1** Requirements for the physically challenged.

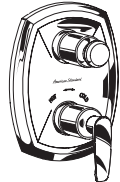

ROUGH VALVE BODIES*	Product Number	Description
	R522	Rough Valve Body Less Trim with built-in 2-way diverter - 1/2" NPT inlets/outlets
	R523	Rough Valve Body Less Trim with built-in 3-way diverter - 1/2" NPT inlets/outlets

NOTES: \*ROUGH & TRIM MUST BE ORDERED SEPARATELY.

R522 and R523 will accept the following trims:

AVAILABLE TRIM KITS	Town Square®	Serin®	Green Tea®	Copeland™
				
T555.740	T064.740 	T010.740 	T005.740	
Moments™	Berwick®	Portsmouth®	Quentin™	
				
T506.740 	T430.740	T420.740	T440.740 	

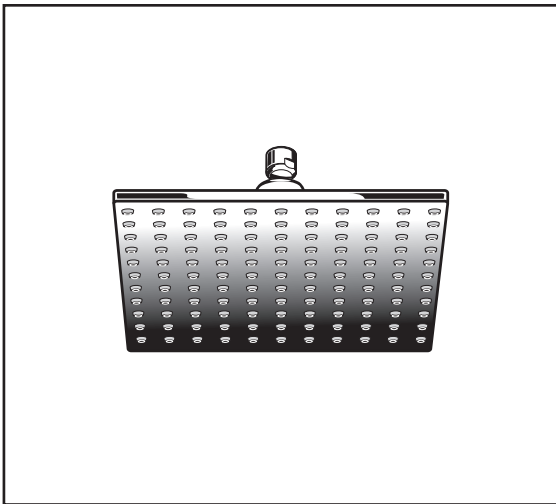

**MODEL NUMBER:**

- ☐ 1660.688 8" Square Rain Showerhead Only

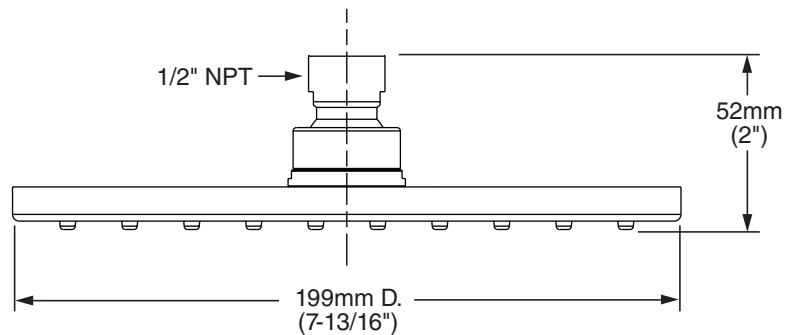

**GENERAL DESCRIPTION:**

8" rain showerhead. Brass construction. Drenching rain spray pattern. Includes pressure compensating flow control device. Brass ball joint. Easy clean spray nozzles. 1/2" NPT connection. 2.5gpm/9.5L/min. maximum flow rate.

**PRODUCT FEATURES:**

**Drenching Rain Spray Pattern:** Gives the user a drenching shower similar to a rain downpour.

**Brass Construction:** Durable. Easy to clean. Ideal for prolonged contact with water.

**Pressure Compensating Flow Control Device:** Provides consistent flow over a wide pressure range.

**Easy Clean Spray Nozzles:** Easily clean lime and calcium buildup. Nozzles will not clog.

**SUGGESTED SPECIFICATION**

Showerhead shall have rain spray pattern and brass ball joint. Showerhead shall have a pressure compensating control device. Fitting shall be American Standard Model # 1660.688,\_\_\_.



**CODES AND STANDARDS**



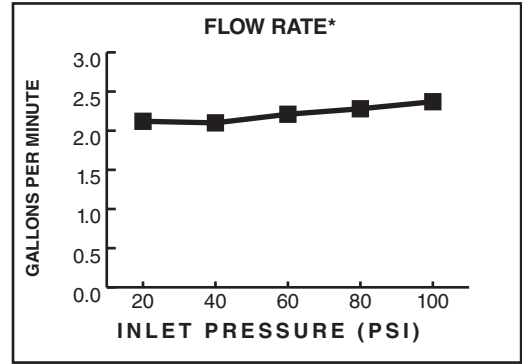







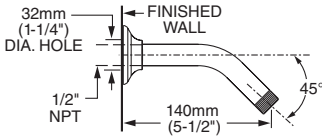

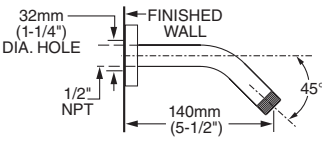

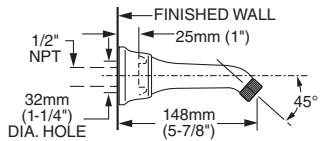

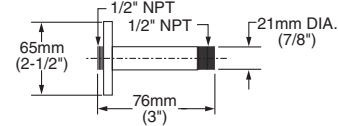

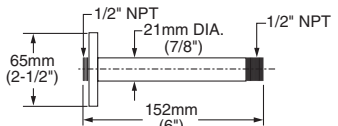
These products meet or exceed the following codes and standards:

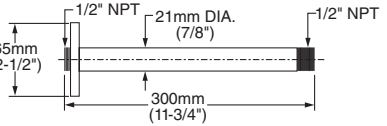
- ASME A112.18.1**
- CSA 125.1**

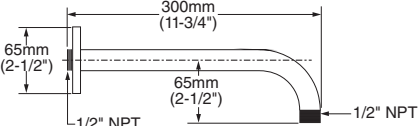

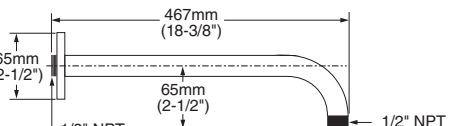
Product Number	Description	Finish Options	
		Polished Chrome	PVD Satin Nickel
		002	295
1660.688	8" Square Rain Showerhead Only		

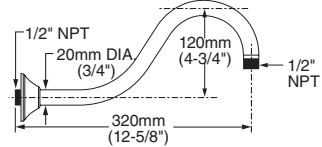
Showerhead Accessories	
Product Number	Description
1660.190	12" Ceiling Mount Shower Arm 
1660.194	12" Wall Mount Right Angle Shower Arm 
1660.191	Square Shower Arm Escutcheon 

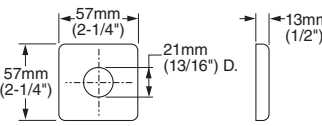
Model #	Description	Finishes	Roughing-In Dimensions
<b>SHOWER ARMS</b>			
1660.240 	<b>STANDARD SHOWER ARM</b> • Brass construction • 1/2" NPT Thread	.002 Polished Chrome .224 Oil Rubbed Bronze .295 Satin Nickel (PVD)	
1660.241 	<b>MODERN SHOWER ARM</b> • Brass construction • 1/2" NPT Thread	.002 Polished Chrome .295 Satin Nickel (PVD)	
1660.242 	<b>SQUARE SHOWER ARM</b> • Cast brass • 1/2" NPT Thread	.002 Polished Chrome .224 Oil Rubbed Bronze .295 Satin Nickel (PVD)	
<b>RAIN SHOWER ARMS</b>			
1660.103 	<b>3" CEILING MOUNT SHOWER ARM</b> • Brass construction • 1/2" NPT Thread	.002 Polished Chrome .295 Satin Nickel (PVD)	
1660.186 	<b>6" CEILING MOUNT SHOWER ARM</b> • Brass construction • 1/2" NPT Thread	.002 Polished Chrome .295 Satin Nickel (PVD)	
1660.190 	<b>12" CEILING MOUNT SHOWER ARM</b> • Brass construction • 1/2" NPT Thread	.002 Polished Chrome .224 Oil Rubbed Bronze .295 Satin Nickel (PVD)	
1660.194 	<b>12" WALL MOUNT RIGHT ANGLE SHOWER ARM</b> • Brass construction • 1/2" NPT Thread	.002 Polished Chrome .224 Oil Rubbed Bronze .295 Satin Nickel (PVD)	
1660.118 	<b>18" WALL MOUNT RIGHT ANGLE SHOWER ARM</b> • Brass construction • 1/2" NPT Thread	.002 Polished Chrome .295 Satin Nickel (PVD)	
1660.198 	<b>12" WALL MOUNT SHEPHERD'S CROOK SHOWER ARM</b> • Brass construction • 1/2" NPT Thread	.002 Polished Chrome .224 Oil Rubbed Bronze .295 Satin Nickel (PVD)	
<b>SHOWER ARM ACCESSORIES</b>			
1660.191 	<b>SQUARE SHOWER FLANGE</b> • Brass construction • For use with: 1660.240 1660.241 1660.190 1660.194	.002 Polished Chrome .295 Satin Nickel (PVD)	

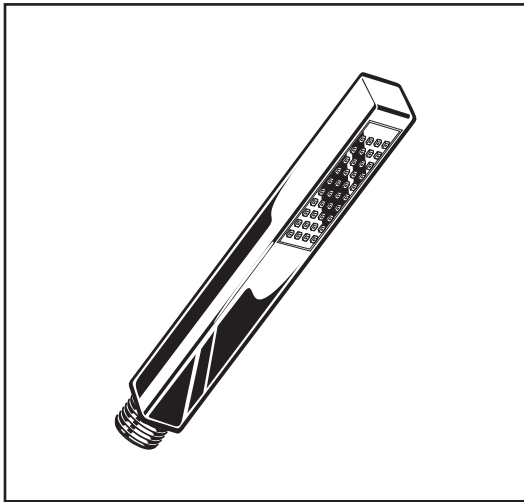

**MODEL NUMBER:**

□ 1660.608 Square Minimalist Hand Shower

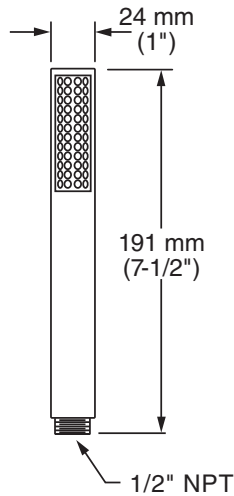

**GENERAL DESCRIPTION:**

Single Function hand shower. Brass handle. Includes check valve to prevent cross flow of hot and cold water. Easy clean spray nozzles. 1.8 gpm/6.8 L/min. maximum flow rate.

**PRODUCT FEATURES:**

**Water Saving:** WaterSense certified.

**Single Function:** Hand shower provides full spray for coverage of the user.

**Easy Clean Spray Nozzles:** Easily clean lime and calcium build up. Nozzles will not clog.



EPA  
WATERSENSE®  
CERTIFIED

**SUGGESTED SPECIFICATION**

Hand Shower shall include check valve to prevent cross flow of hot and cold water. Fitting shall be American Standard Model # 1660.608.\_\_\_\_\_.







**CODES AND STANDARDS**

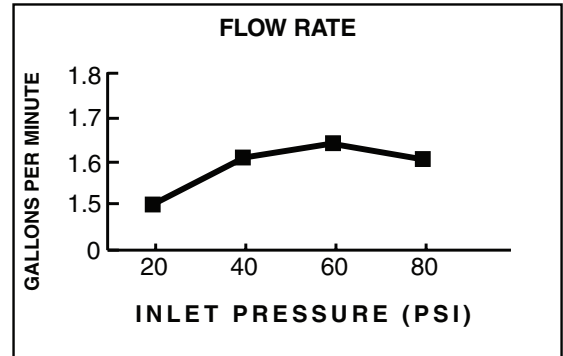



These products meet or exceed the following codes and standards:

**ASME A112.18.1  
CSA B125.1**







Product Number	Description	Finish			
		Polished Chrome	Legacy Bronze	Polished Nickel	Brushed Nickel
		002	278	013	295
1660.608	Square Minimalist Hand Shower.				

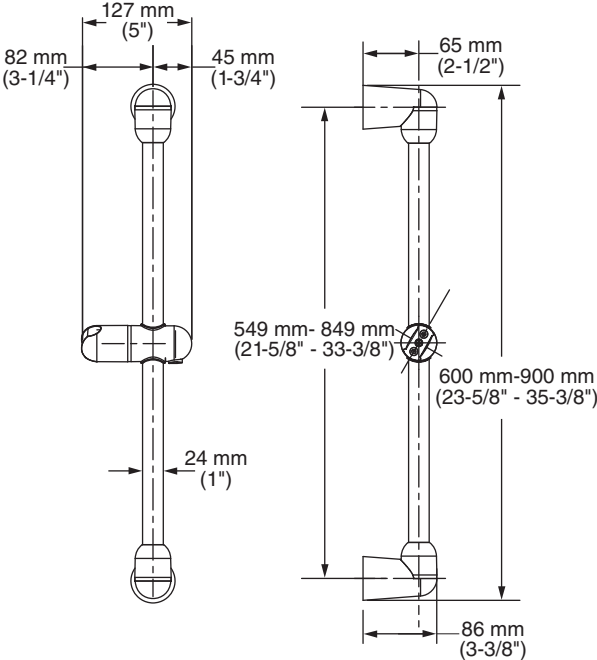
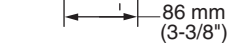
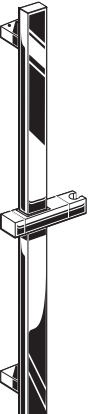
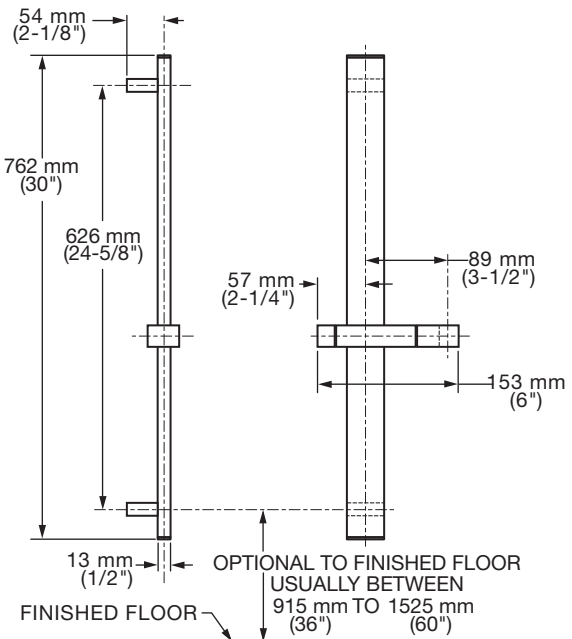

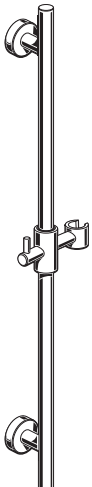
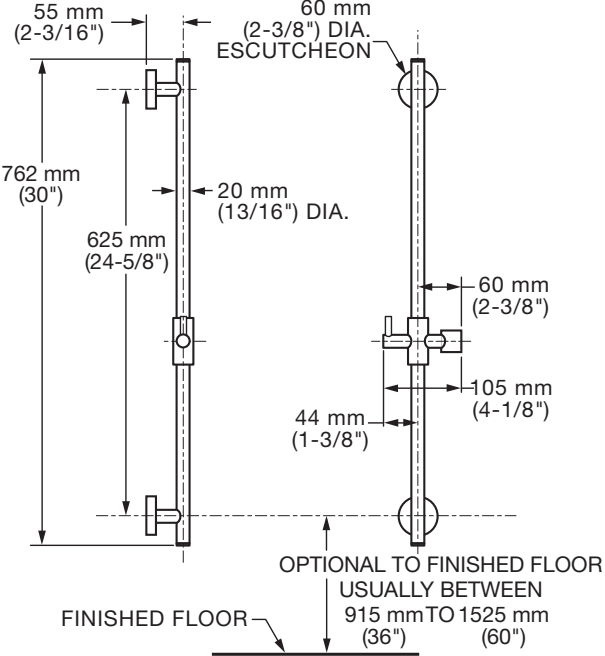
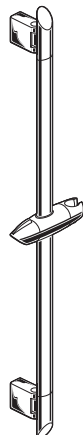
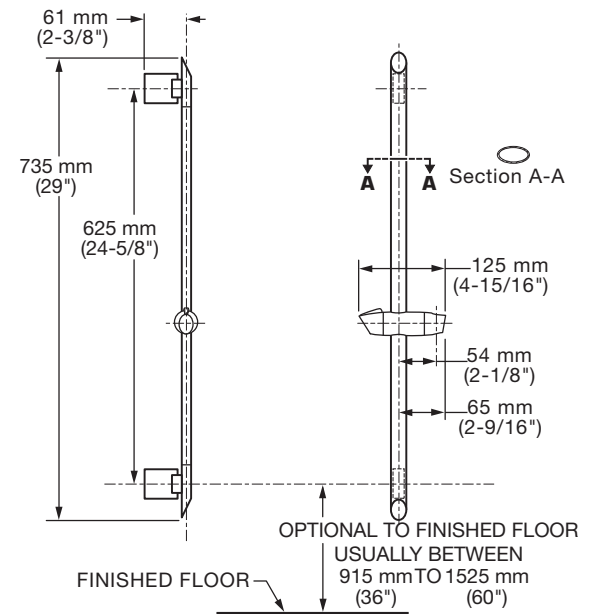

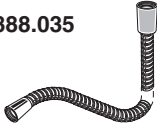

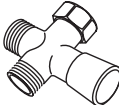
Hand Shower Accessories	
Product Number	Description
8888.035	59" Metal Shower Hose 
8888.053	79" Metal Shower Hose (Chrome Only) 
1660.400	Vacuum Breaker 
1660.410	Shower Arm Diverter 
8888.096	Shower Arm Bracket 

Hand Shower Accessories	
Product Number	Description
8888.036	Fixed Wall Bracket 
8888.037	Wall Supply 
8888.068	Round Wall Supply 
8888.069	Square Wall Supply 
8888.038	Wall Supply Bracket 

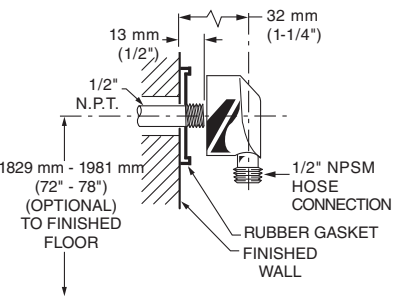
Model #	Description	Finishes	Rough-In Dimensions
<p><b>1660.225</b></p> 	<p><b>24" (600 mm) STANDARD SLIDE BAR</b></p> <p>Adjustable shower holder can be set at any height or position along the bar and angles up to 45 degrees.</p>	<p>.002 Polished Chrome .224 Oil Rubbed Bronze .295 Brushed Nickel</p>	
<p><b>1660.236</b></p>	<p><b>36" (900 mm) STANDARD SLIDE BAR</b></p>	<p>.002 Polished Chrome .224 Oil Rubbed Bronze .295 Brushed Nickel</p>	
<p><b>1660.230</b></p> 	<p><b>30" (762 mm) SQUARE SLIDE BAR</b></p> <ul style="list-style-type: none"> <li>Adjustable bracket for personal showers</li> <li>Matching square wall brackets</li> </ul>	<p>.002 Polished Chrome .295 Brushed Nickel .013 Polished Nickel .278 Legacy Bronze</p>	

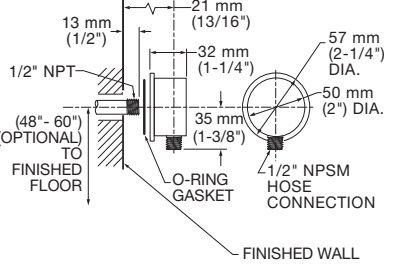
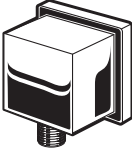
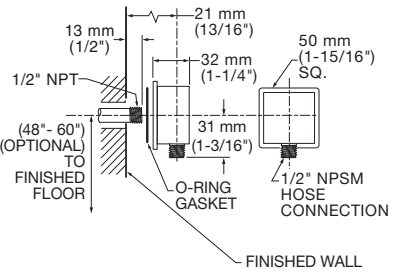
Model #	Description	Finishes	Rough-In Dimensions
<p><b>1660.330</b></p> 	<p><b>30" (762 mm) ROUND SLIDE BAR</b></p> <ul style="list-style-type: none"> <li>Adjustable bracket for personal showers</li> <li>Round wall flange</li> </ul>	<p>.002 Polished Chrome</p>	
<p><b>1660.530</b></p> 	<p><b>29" (737 mm) ELLIPTIC SLIDE BAR</b></p> <ul style="list-style-type: none"> <li>Adjustable bracket for personal showers</li> <li>Square wall flange brackets</li> <li>45° pivoting bar</li> </ul>	<p>.002 Polished Chrome</p>	

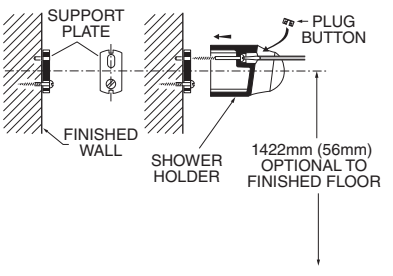
Model #	Description/Features	Finishes
<p>8888.035</p> 	<p><b>59" (1500MM) METAL SHOWER HOSE</b> Threads directly on 1/2" NPSM male threaded personal hand held shower.</p>	<p>.002 Polished Chrome .224 Oil Rubbed Bronze .295 Satin Nickel (PVD) .243 Matte Black</p>
<p>8888.053</p>	<p><b>79" (2007MM) METAL SHOWER HOSE</b></p>	<p>.002 Polished Chrome</p>
<p>1660.400</p> 	<p><b>1/2" NPT IN-LINE VACUUM BREAKER</b> • Attaches between supply outlet and personal shower hose.</p>	<p>.002 Polished Chrome .224 Oil Rubbed Bronze .295 Satin Nickel (PVD)</p>
<p>1660.410</p> 	<p><b>SHOWER ARM DIVERTER</b> • Attaches to shower arm • Controls water flow between showerhead and hand held shower • 1/2" NPT connections</p>	<p>.002 Polished Chrome .295 Satin Nickel (PVD)</p>
<p>8888.096</p> 	<p><b>SHOWER ARM BRACKET</b> • Attaches to shower arm • Metal ball joint • Angle adjustable • 1/2" NPT connections</p>	<p>.002 Polished Chrome .224 Oil Rubbed Bronze .295 Satin Nickel (PVD)</p>

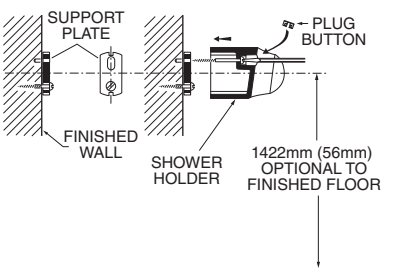
Model #	Description	Finishes	Rough-In Dimensions
<p><b>8888.037</b></p> 	<p><b>WALL SUPPLY</b></p> <ul style="list-style-type: none"> <li>• 1/2" NPT female thread</li> <li>• 1/2" NPSM male hose thread</li> </ul>	<p>.002 Polished Chrome .224 Oil Rubbed Bronze .295 Brushed Nickel .013 Polished Nickel .278 Legacy Bronze</p>	
<p><b>8888.068</b></p> 	<p><b>ROUND WALL SUPPLY</b></p> <ul style="list-style-type: none"> <li>• 1/2" NPT female thread</li> <li>• 1/2" NPSM male hose thread</li> <li>• Includes check valve</li> </ul>	<p>.002 Polished Chrome .295 Brushed Nickel</p>	
<p><b>8888.069</b></p> 	<p><b>SQUARE WALL SUPPLY</b></p> <ul style="list-style-type: none"> <li>• 1/2" NPT female thread</li> <li>• 1/2" NPSM male hose thread</li> <li>• Includes check valve</li> </ul>	<p>.002 Polished Chrome .295 Brushed Nickel .013 Polished Nickel .278 Legacy Bronze</p>	
<p><b>8888.036</b></p> 	<p><b>FIXTURE WALL BRACKET</b></p> <ul style="list-style-type: none"> <li>• For use with personal showers</li> </ul>	<p>.002 Polished Chrome .224 Oil Rubbed Bronze .295 Brushed Nickel .013 Polished Nickel .278 Legacy Bronze</p>	
<p><b>8888.038</b></p> 	<p><b>WALL SUPPLY BRACKET</b></p> <ul style="list-style-type: none"> <li>• 1/2" NPT female threads</li> <li>• Integral bracket holds the handshower at a convenient angle.</li> </ul>	<p>.002 Polished Chrome .224 Oil Rubbed Bronze .295 Brushed Nickel</p>	

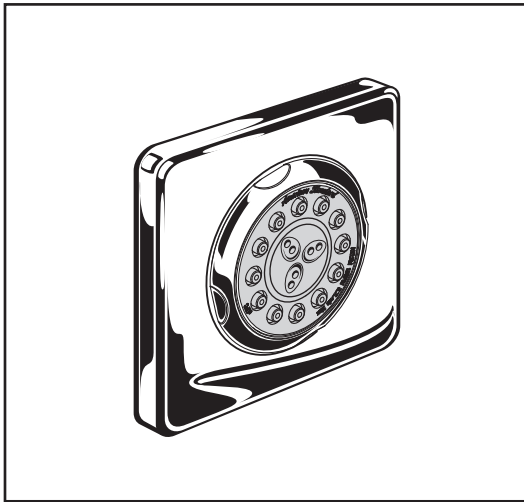

**MODEL NUMBER:**

- **1660.140 Multifunction Square Body Spray**  
Flush mount. 1/2" NPT male connection.

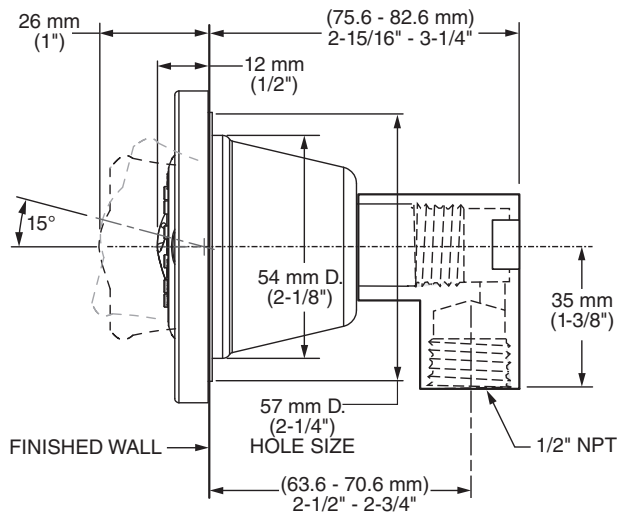
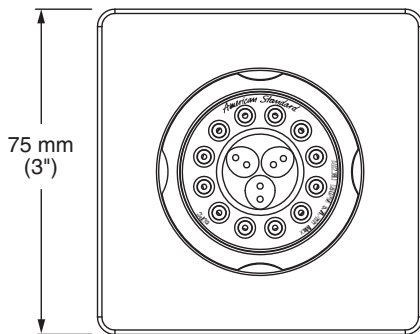

**GENERAL DESCRIPTION:**

Flush mount body spray. Swivel spray with adjustable spray pattern automatically extends when water is turned on and auto retracts when water is turned off. Spray pattern adjusts from full spray to combination to massage. Spray position adjusts up to 15° in any direction. Easy clean spray nozzles. Brass escutcheon. Fits wall cavity using standard 2" x 4" studs. Installs as one piece. Plaster guard serves as a rough-in guide and pipe plug. 1.5 gpm/5.7 L/min. maximum flow rate.

**PRODUCT FEATURES:**

- Flush Mount:** Clean look.
- Adjustable Spray Pattern:** 3 spray options to customize shower experience to personal taste.
- Simple Spray Adjustment:** Spray position adjusts up to 15° in any direction.
- One Piece Installation:** No loose parts to lose or reassemble on site.
- Easy Clean Spray Nozzles:** Easily clean lime and calcium buildup.

**SUGGESTED SPECIFICATION**

Body Spray shall be flush mount to wall projecting no more than 1/2" when not in use. Body spray shall have at least 3 spray patterns. Features an automatic swivel spray that extends when water is turned on and retracts when water is turned off. Fitting shall be American Standard Model # 1660.140.\_\_\_\_\_.

**CODES AND STANDARDS**

These products meet or exceed the following codes and standards:

**ASME A112.18.1**  
**CSA B125.1**

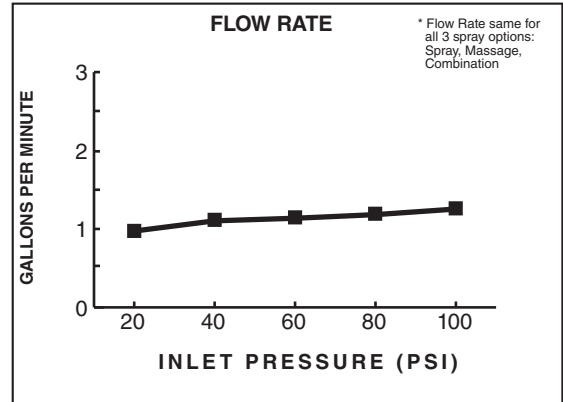

Product Number	Description	Finish Options				
		Legacy Bronze	Polished Nickel	Polished Chrome	Oil Rubbed Bronze	Brushed Nickel
		278	013	002	224	295
1660.140	Extender Multifunction Round Body Spray.					