

TU455502 Bath/Shower Trim Shown

**GENERAL DESCRIPTION:**

**Double Ceramic Pressure Balance Cartridge:** Features one-piece design with ceramic discs and ceramic balancing spool. Includes integrated check valves and hot limit safety stop. Cartridge is back to back capable. Ceramic balancing spool maintains constant output temperature in response to changes in relative hot and cold supply pressure. Washerless ceramic discs provide smooth handle movement and are unaffected by harsh water conditions.

**Trim:** Features 6-1/4" showerhead with a maximum 2.5 gpm/9.5 L/min. flow rate. Metal slip-on diverter spout. Metal wall valve trim with metal lever.

**PRODUCT FEATURES**

**One-Piece Cartridge:** Simplifies installation and maintenance.

**Double Ceramic Pressure Balance Cartridge:** Combination of Ceramic Disc Mixing Valve and a Ceramic Balancing Spool in a one-piece cartridge.

**Ceramic Disc Mixing Valve:** Assures a lifetime of drip-free performance and smooth handle operation.

**Ceramic Balancing Spool:** Maintains a constant output temperature in response to changes in relative hot and cold supply pressure. Ceramic material is unaffected by mineral deposits and harsh water conditions.

**Integrated Check Valves:** Engineered to eliminate cross flow.

**Adjustable Hot Limit Safety Stop:** Limits the amount of hot water allowed to mix with cold. Reduces the risk of accidental scalding.

**Comfort Zone:** Offers a wider shower range to fine tune the desired temperature within the useful temperature zone.

**Back-to-Back Capability:** Hot and cold can be reversed quickly and easily.

**MODEL NUMBER:**

**TRIM KITS:**

- ❑ **TU455502 Town Square S Bath/Shower Trim Kit with Pressure Balance Cartridge**  
Lever handle. LESS valve body.
- ❑ **TU455501 Town Square S Shower ONLY Trim Kit with Pressure Balance Cartridge**  
Lever handle. LESS valve body.
- ❑ **TU455500 Town Square S Valve ONLY Trim Kit with Pressure Balance Cartridge**  
Lever handle. LESS valve body.

**For use with Flash™ Rough Valve Bodies**

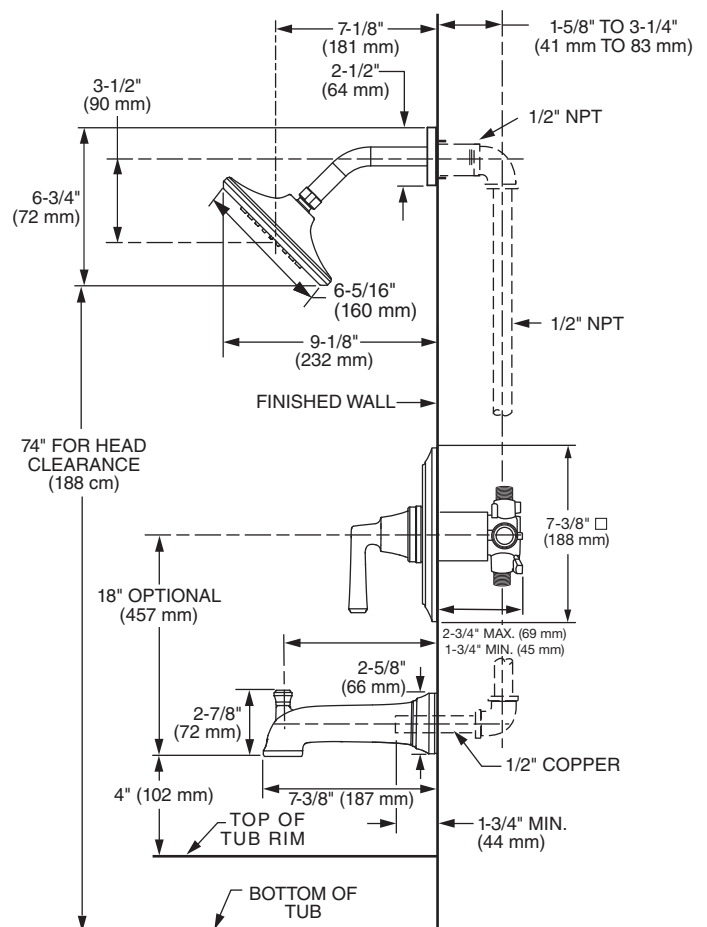

**SUGGESTED SPECIFICATION**

Bath/shower fitting shall feature showerhead with Max. 2.5 gpm/9.5 L/min. flow rate. Shall feature double ceramic pressure balance cartridge which is capable of back-to-back installation. Cartridge shall feature integrated check valves to eliminate cross flow. Capable of meeting ASSE1016 @1.3gpm. Cartridge shall also feature hot limit safety stop. Fitting shall be: American Standard - Trim Kit Model # TU45550\_ and Flash Valve Body Model # RU10\_.



# Town Square®S

## Pressure Balance Bath/Shower Trim

### with Double Ceramic Pressure Balance Cartridge

### CODES AND STANDARDS

These products meet or exceed the following codes and standards:

**ASSE 1016 / ASME A112.18.1016 / CSA B125.16**

**ASME A112.18.1 / CSA B125.1**

**Rated to meet ASSE 1016 @ 1.3gpm**

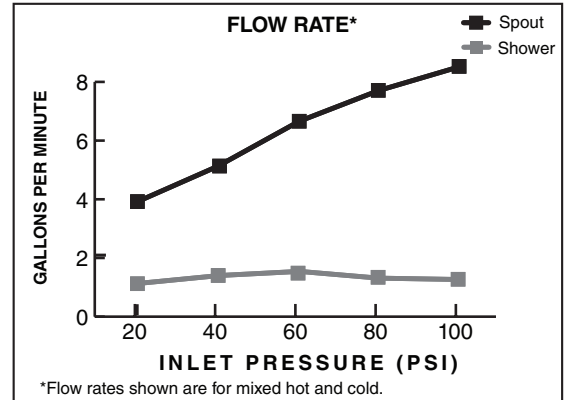

TRIM KITS*	Product Number	Description	Finish Options			
			Polished Chrome	PVD Polished Nickel	Legacy Bronze	PVD Brushed Nickel
			002	013	278	295
TU455502	Bath/Shower Trim Kit. Metal lever handle. Showerhead. LESS valve body.					
TU455501	Shower Only Trim Kit. Metal lever handle. Showerhead. LESS valve body.					
TU455500	Valve Only Trim Kit. Metal lever handle. LESS valve body.					

**\* TRIM & ROUGH MUST BE ORDERED SEPARATELY.**

Flash™ ROUGH VALVE BODIES	Product Description	Without Screwdriver Stops	With Screwdriver Stops
		Rough Valve Body. Universal* inlets/outlets.	RU101
Rough Valve Body. Stub-out inlets/outlets for Press-Fit Fittings.	RU102	RU102SS	
Rough Valve Body. PEX inlets/Universal outlets for Crimp Ring PEX system (ASTM F1807).	RU107	RU107SS	
Rough Valve Body. PEX Elbow inlets/Universal outlets for Crimp Ring PEX system (ASTM F1807).	RU107E	RU107ESS	
Rough Valve Body. PEX inlets/Universal outlets for Cold Expansion PEX system (ASTM F1960).	RU108	RU108SS	
Rough Valve Body. PEX Elbow inlets/Universal outlets for Cold Expansion PEX system (ASTM F1960).	RU108E	RU108ESS	
Rough Valve Body. CPVC inlets/Universal outlets.	RU109	RU109SS	

OPTIONAL ACCESSORY	Product Number	Product Description
	M954805-0070A	Deep Rough-In Kit

Meets the American Disabilities Act Guidelines and **ANSI A117.1** Requirements for the physically challenged.

PART OF **LIXIL**

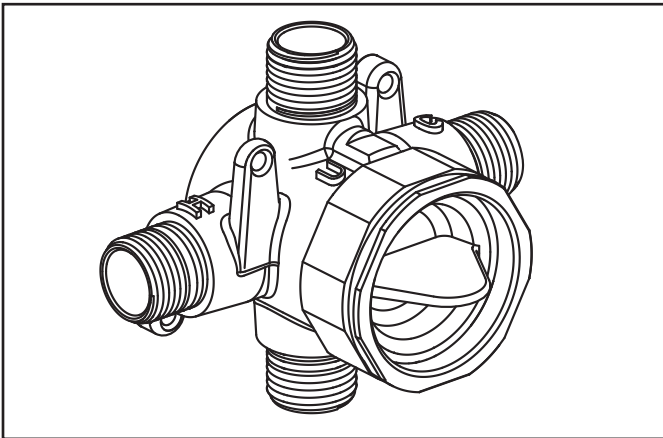

**RU101 SHOWN**

**GENERAL DESCRIPTION:**

Valve body features cast brass construction with a pre-installed test cap. Features back-to-back capability. One-half inch inlets and outlets (choice of Universal, PEX Crimp, PEX Cold Expansion, CPVC or Stub-outs). Features test cap with stainless steel retaining ring with flats. Available with screwdriver stops. Rough-in plaster guard designed as rough-in guide and for use as thin wall mounting support. For use with TU series trim kits with cartridges.

**PRODUCT FEATURES:**

**Choice of Connections:** Fast and easy installation without adaptors reducing leak points. Available connections include Universal (male thread/female sweat), PEX Crimp, PEX Cold expansion, CPVC, and Stub-outs.

**Cast Brass Valve Body:** Durable. Ideal material for prolonged contact with water.

**Flat Back:** Allows valve to be mounted flush against cross brace for easy and solid installation.

**Test Cap:** Allows valve body to be tested and flushed without the presence of the valve cartridge. Can be tested using test cap with air (200 psi) or water (300 psi).

**Stainless Steel Retaining Ring with Flats:** Secures test cap/cartridge in place and eliminates need for screws. Flats make it simple to loosen ring for quick, easy insertion/removal of test cap/cartridge.

**Back-to-Back Capability:** Hot and cold can be reversed quickly and easily.

**Exclusive Plaster Guard:** Plaster guard is designed to protect valve and act as a guide during installation. It can serve as mounting support for thin-wall installations.

**Wide Rough-in Range:** From 1-3/4" to 2-3/4" from finished wall to the back of the valve.

**MODEL NUMBERS:**

- RU101 Flash Rough Valve Body with Flash Connections**  
1/2" Universal inlets/outlets.
- RU101SS Flash Rough Valve Body with Flash Connections with Screwdriver Stops**  
1/2" Universal inlets/outlets.
- RU102 Flash Rough Valve Body with Stub-Out Connections**  
1/2" Stub-out inlets/outlets.
- RU102SS Flash Rough Valve Body with Stub-Out Connections with Screwdriver Stops**  
1/2" Stub-out inlets/outlets.
- RU107 Flash Rough Valve Body with PEX Crimp Connections**  
1/2" PEX Crimp inlets (ASTM F1807) / Universal outlets.
- RU107SS Flash Rough Valve Body with PEX Crimp Connections with Screwdriver Stops**  
1/2" PEX Crimp inlets (ASTM F1807) / Universal outlets.
- RU107E Flash Rough Valve Body with PEX Crimp Elbow Connections**  
1/2" PEX Crimp Elbow inlets (ASTM F1807) / Universal outlets.
- RU107ESS Flash Rough Valve Body with PEX Crimp Elbow Connections with Screwdriver Stops**  
1/2" PEX Crimp Elbow inlets (ASTM F1807) / Universal outlets.
- RU108 Flash Rough Valve Body with PEX Cold Expansion Connections**  
1/2" PEX Cold Expansion inlets (ASTM F1960) / Universal outlets.
- RU108SS Flash Rough Valve Body with PEX Cold Expansion Connections with Screwdriver Stops**  
1/2" PEX Cold Expansion inlets (ASTM F1960) / Universal outlets.
- RU108E Flash Rough Valve Body with PEX Cold Expansion Elbow Connections**  
1/2" PEX Cold Expansion Elbow inlets (ASTM F1960) / Universal outlets.
- RU108ESS Flash Rough Valve Body with PEX Cold Expansion Elbow Connections with Screwdriver Stops**  
1/2" PEX Cold Expansion Elbow inlets (ASTM F1960) / Universal outlets.
- RU109 Flash Rough Valve Body with CPVC Connections**  
1/2" CPVC inlets / Universal outlets.
- RU1098SS Flash Rough Valve Body with CPVC Connections with Screwdriver Stops**  
1/2" CPVC inlets / Universal outlets.

**SUGGESTED SPECIFICATION**

Rough Valve Body shall feature a cast brass body. Shall feature back-to-back capability. Valve Body shall feature test cap to flush and test the lines. Shall feature stainless steel retaining ring with flats. Rough Valve Body shall be: Rough Valve Body - American Standard Model # RU10\_\_\_\_.

UNIVERSAL	
<p><b>RU101</b></p> <p><b>INLETS</b> ½" NOM. COPPER SWEAT or ½" MALE NPT</p> <p><b>OUTLETS</b> ½" NOM. COPPER SWEAT or ½" MALE NPT</p>	<p><b>RU101SS</b></p> <p><b>INLETS</b> ½" NOM. COPPER SWEAT or ½" MALE NPT</p> <p><b>OUTLETS</b> ½" NOM. COPPER SWEAT or ½" MALE NPT</p>
STUB-OUT FOR PRESS-CONNECT FITTINGS	
<p><b>RU102</b></p> <p><b>INLETS</b> ½" STUB OUT</p> <p><b>OUTLETS</b> ½" STUB OUT</p>	<p><b>RU102SS</b></p> <p><b>INLETS</b> ½" STUB OUT</p> <p><b>OUTLETS</b> ½" STUB OUT</p>
PEX-CRIMP	
<p><b>RU107</b></p> <p><b>INLETS</b> ½" PEX (ASTM F1807-2)</p> <p><b>OUTLETS</b> ½" NOM. COPPER SWEAT or ½" MALE NPT</p>	<p><b>RU107SS</b></p> <p><b>INLETS</b> SWEAT or ½" PEX (ASTM F1807-2)</p> <p><b>OUTLETS</b> ½" NOM. COPPER SWEAT or ½" MALE NPT</p>
<p><b>RU107E</b></p> <p><b>INLETS</b> ½" PEX (ASTM F1960)</p> <p><b>OUTLETS</b> ½" NOM. COPPER SWEAT or ½" MALE NPT</p> <p><i>Valve can be rotated 180° for ceiling mount supply lines</i></p>	<p><b>RU107ESS</b></p> <p><b>INLETS</b> ½" PEX (ASTM F1960)</p> <p><b>OUTLETS</b> ½" NOM. COPPER SWEAT or ½" MALE NPT</p> <p><i>Valve can be rotated 180° for ceiling mount supply lines</i></p>
PEX-COLD EXPANSION	
<p><b>RU108</b></p> <p><b>INLETS</b> ½" PEX (ASTM F1960)</p> <p><b>OUTLETS</b> ½" NOM. COPPER SWEAT or ½" MALE NPT</p>	<p><b>RU108SS</b></p> <p><b>INLETS</b> ½" PEX (ASTM F1960)</p> <p><b>OUTLETS</b> ½" NOM. COPPER SWEAT or ½" MALE NPT</p>
<p><b>RU108E</b></p> <p><b>INLETS</b> ½" PEX (ASTM F1960)</p> <p><b>OUTLETS</b> ½" NOM. COPPER SWEAT or ½" MALE NPT</p> <p><i>Valve can be rotated 180° for ceiling mount supply lines</i></p>	<p><b>RU108ESS</b></p> <p><b>INLETS</b> ½" PEX (ASTM F1960)</p> <p><b>OUTLETS</b> ½" NOM. COPPER SWEAT or ½" MALE NPT</p> <p><i>Valve can be rotated 180° for ceiling mount supply lines</i></p>
CPVC	
<p><b>RU109</b></p> <p><b>INLETS</b> ½" NOM CPVC</p> <p><b>OUTLETS</b> ½" NOM. COPPER SWEAT or ½" MALE NPT</p>	<p><b>RU109SS</b></p> <p><b>INLETS</b> ½" NOM CPVC</p> <p><b>OUTLETS</b> ½" NOM. COPPER SWEAT or ½" MALE NPT</p>

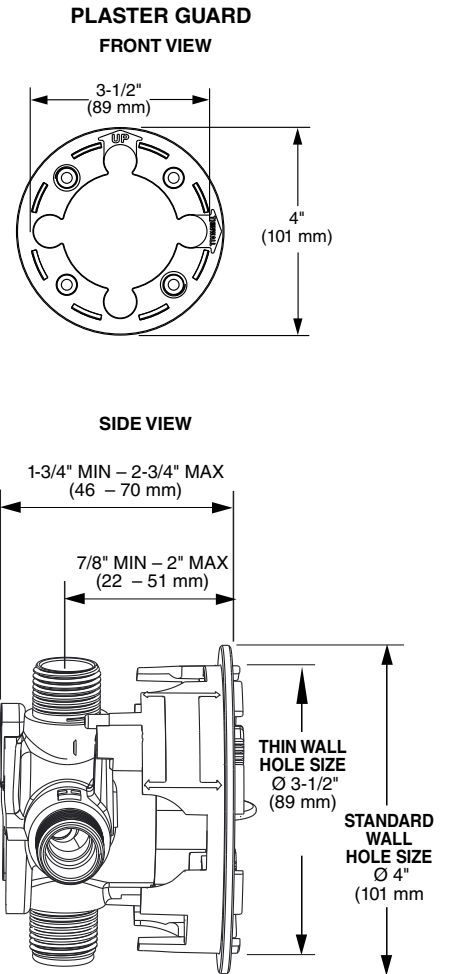

**NOTE:** TO AVOID SHOWER RISE OR OTHER RELATED ISSUES, DO NOT USE PEX CONNECTIONS ON ANY OF THE OUTLETS.

## CODES AND STANDARDS

These products meet or exceed the following codes and standards:

**ASSE 1016 / ASME A112.18.1016 / CSA B125.16**

**ASME A112.18.1 / CSA B125.1**

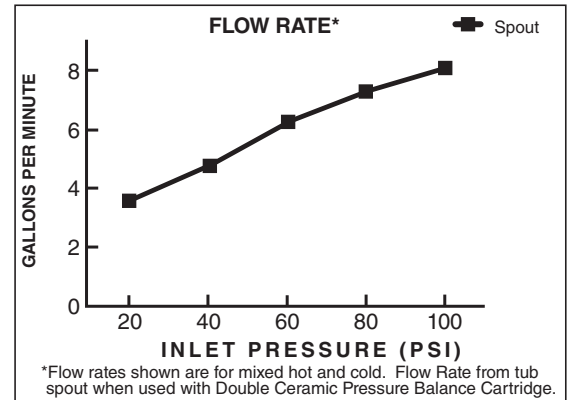

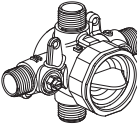
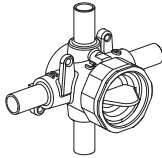
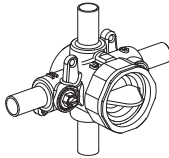
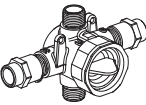
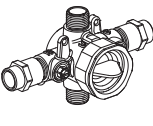
UNIVERSAL		STUB-OUT FOR PRESS-CONNECT FITTINGS		CPVC	
<b>RU101</b>	<b>RU101SS</b>	<b>RU102</b>	<b>RU102SS</b>	<b>RU109</b>	<b>RU109SS</b>
					
½" Universal Inlets/ Outlets	½" Universal Inlets/ Outlets	½" Stub-Out Inlets/ Outlets	½" Stub-Out Inlets/ Outlets	½" CPVC Inlets/ Universal Outlets	½" CPVC Inlets/ Universal Outlets
	<b>Screwdriver Stops</b>		<b>Screwdriver Stops</b>		<b>Screwdriver Stops</b>

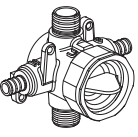
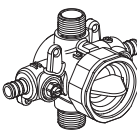
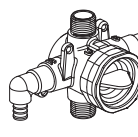
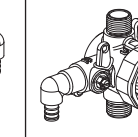
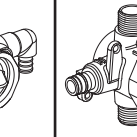
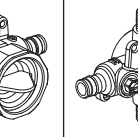
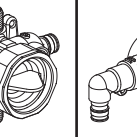
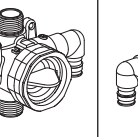
PEX - CRIMP (ASTM F1807)				PEX - COLD EXPANSION (ASTM 1960)			
<b>RU107</b>	<b>RU107SS</b>	<b>RU107E</b>	<b>RU107ESS</b>	<b>RU108</b>	<b>RU108SS</b>	<b>RU108E</b>	<b>RU108ESS</b>
							
½" PEX Crimp Inlets/ Flash Outlets	½" PEX Crimp Inlets/ Universal Outlets	½" PEX Crimp Elbow Inlets/ Universal Outlets	½" PEX Crimp Elbow Inlets/ Universal Outlets	½" PEX Cold Expansion Inlets/ Universal Outlets	½" PEX Cold Expansion Inlets/ Universal Outlets	½" PEX Cold Expansion Elbow Inlets/ Universal Outlets	½" PEX Cold Expansion Elbow Inlets/ Universal Outlets
	<b>Screwdriver Stops</b>		<b>Screwdriver Stops</b>		<b>Screwdriver Stops</b>		<b>Screwdriver Stops</b>

\*Universal = Male IPS Thread/Female Sweat

OPTIONAL ACCESSORIES	
<b>M954334-0070A</b>	Flush Plug
<b>M954805-0070A</b>	Deep Rough-in Kit

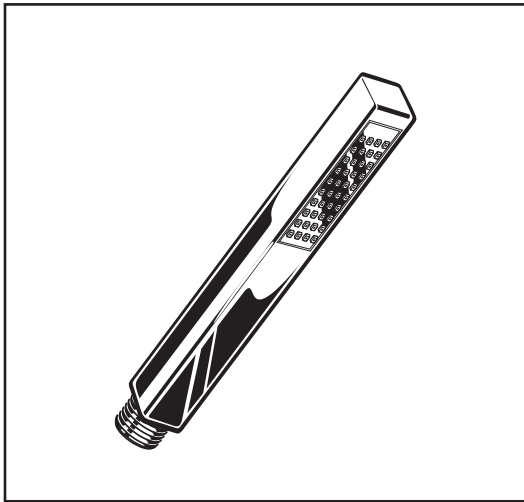

**MODEL NUMBER:**

□ 1660.608 Square Minimalist Hand Shower

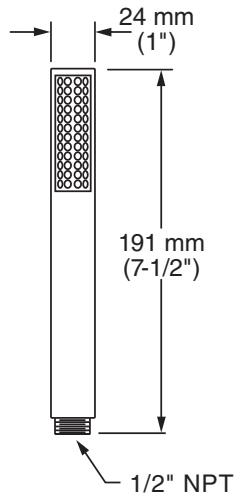

**GENERAL DESCRIPTION:**

Single Function hand shower. Brass handle. Includes check valve to prevent cross flow of hot and cold water. Easy clean spray nozzles. 1.8 gpm/6.8 L/min. maximum flow rate.

**PRODUCT FEATURES:**

**Water Saving:** WaterSense certified.

**Single Function:** Hand shower provides full spray for coverage of the user.

**Easy Clean Spray Nozzles:** Easily clean lime and calcium build up. Nozzles will not clog.



EPA  
WATERSENSE®  
CERTIFIED

**SUGGESTED SPECIFICATION**

Hand Shower shall include check valve to prevent cross flow of hot and cold water. Fitting shall be American Standard Model # 1660.608.\_\_\_\_\_.







**CODES AND STANDARDS**

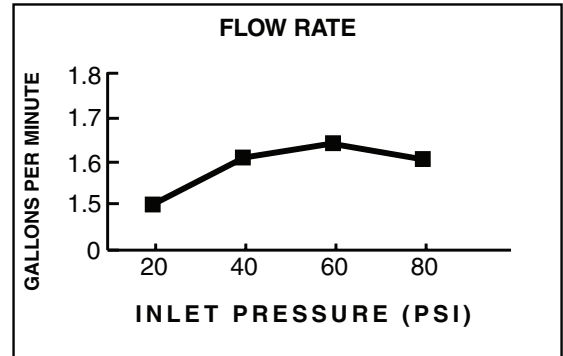



These products meet or exceed the following codes and standards:

**ASME A112.18.1  
CSA B125.1**



Product Number	Description	Finish			
		Polished Chrome	Legacy Bronze	Polished Nickel	Brushed Nickel
		002	278	013	295
1660.608	Square Minimalist Hand Shower.				



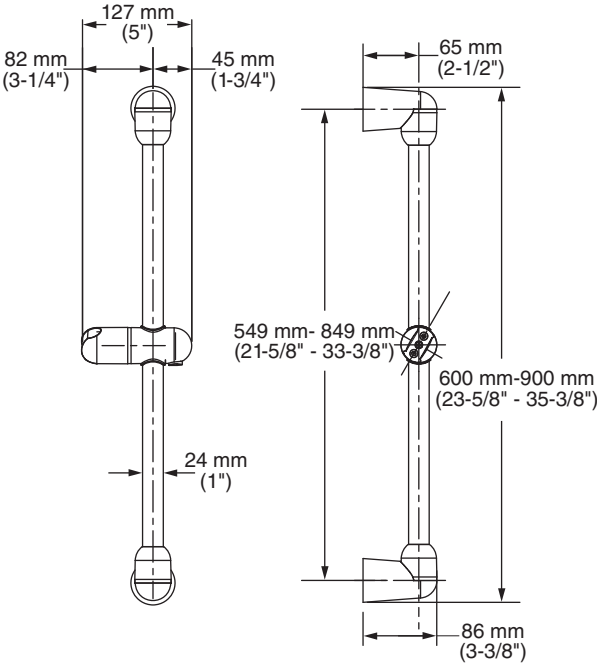
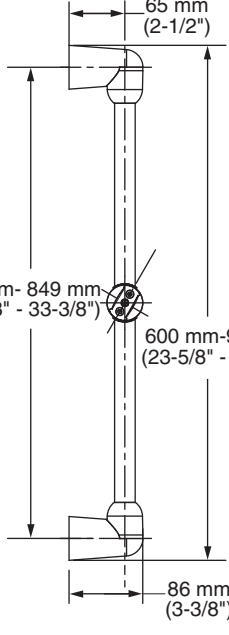
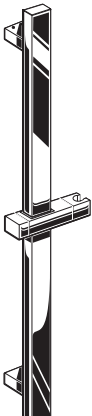
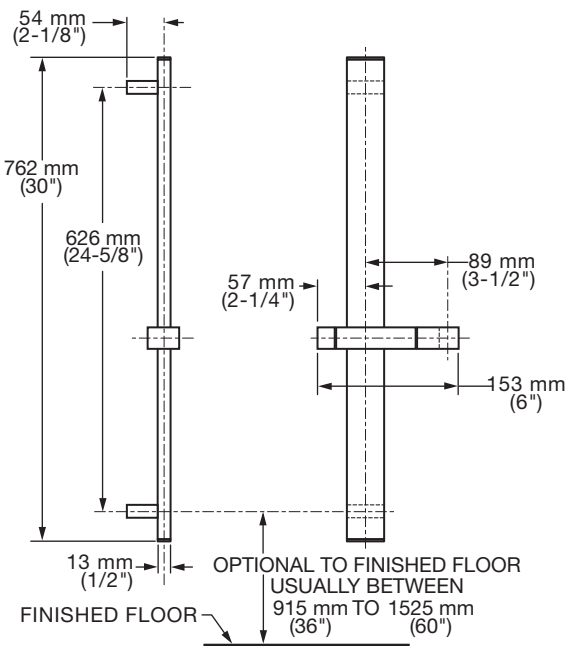

Hand Shower Accessories	
Product Number	Description
8888.035	59" Metal Shower Hose 
8888.053	79" Metal Shower Hose (Chrome Only) 
1660.400	Vacuum Breaker 
1660.410	Shower Arm Diverter 
8888.096	Shower Arm Bracket 



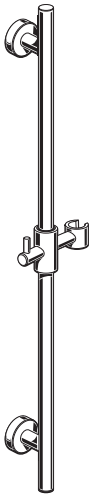
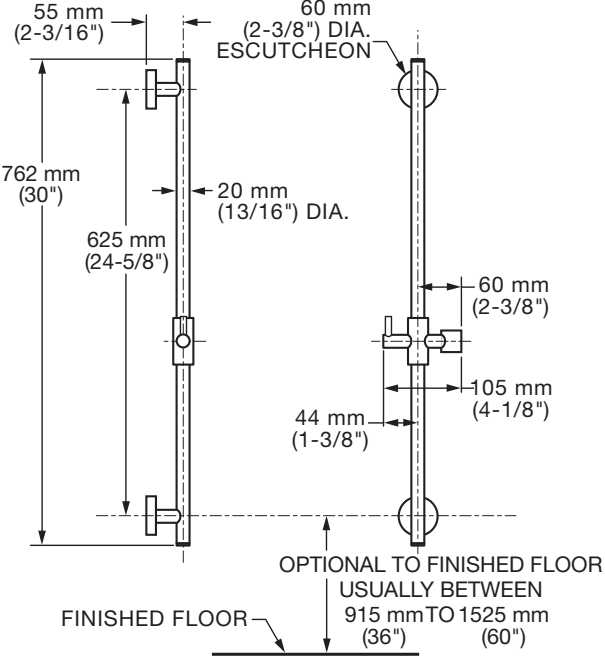
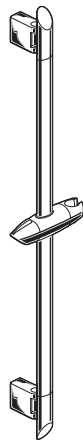
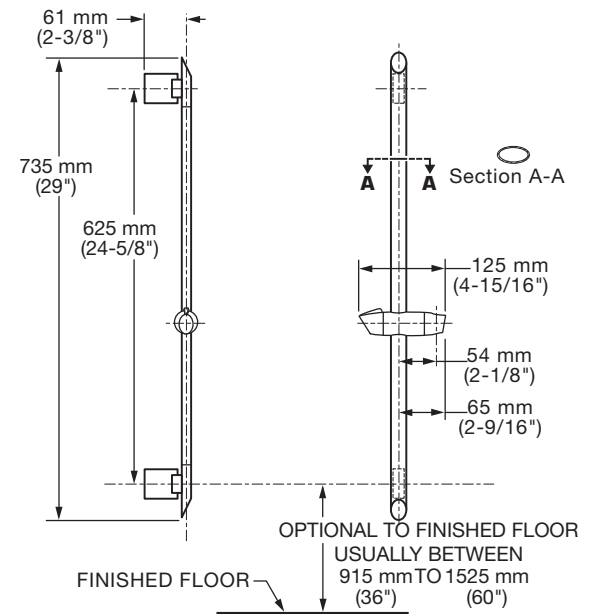

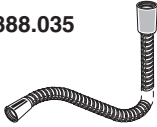

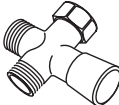
Hand Shower Accessories	
Product Number	Description
8888.036	Fixed Wall Bracket 
8888.037	Wall Supply 
8888.068	Round Wall Supply 
8888.069	Square Wall Supply 
8888.038	Wall Supply Bracket 

Model #	Description	Finishes	Rough-In Dimensions
<p><b>1660.225</b></p> 	<p><b>24" (600 mm) STANDARD SLIDE BAR</b></p> <p>Adjustable shower holder can be set at any height or position along the bar and angles up to 45 degrees.</p>	<p>.002 Polished Chrome .224 Oil Rubbed Bronze .295 Brushed Nickel</p>	
<p><b>1660.236</b></p>	<p><b>36" (900 mm) STANDARD SLIDE BAR</b></p>	<p>.002 Polished Chrome .224 Oil Rubbed Bronze .295 Brushed Nickel</p>	
<p><b>1660.230</b></p> 	<p><b>30" (762 mm) SQUARE SLIDE BAR</b></p> <ul style="list-style-type: none"> <li>Adjustable bracket for personal showers</li> <li>Matching square wall brackets</li> </ul>	<p>.002 Polished Chrome .295 Brushed Nickel .013 Polished Nickel .278 Legacy Bronze</p>	

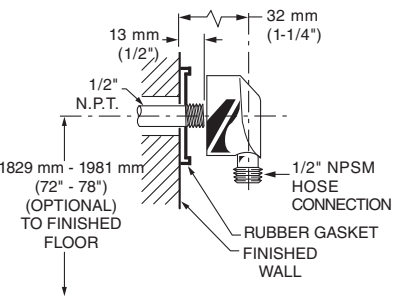

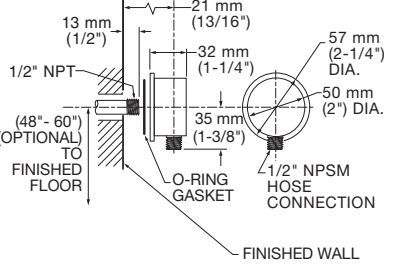
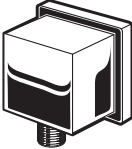
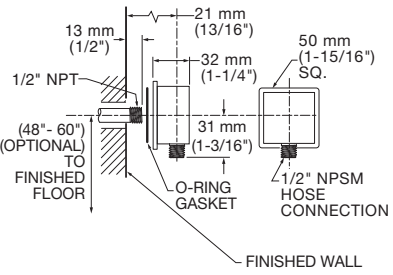
Model #	Description	Finishes	Rough-In Dimensions
<p><b>1660.330</b></p> 	<p><b>30" (762 mm) ROUND SLIDE BAR</b></p> <ul style="list-style-type: none"> <li>Adjustable bracket for personal showers</li> <li>Round wall flange</li> </ul>	<p>.002 Polished Chrome</p>	
<p><b>1660.530</b></p> 	<p><b>29" (737 mm) ELLIPTIC SLIDE BAR</b></p> <ul style="list-style-type: none"> <li>Adjustable bracket for personal showers</li> <li>Square wall flange brackets</li> <li>45° pivoting bar</li> </ul>	<p>.002 Polished Chrome</p>	

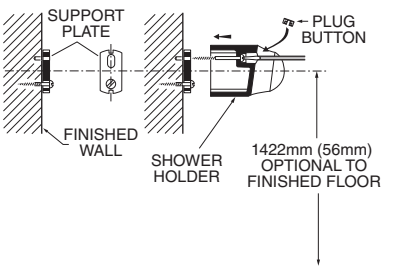
Model #	Description/Features	Finishes
<p>8888.035</p> 	<p><b>59" (1500MM) METAL SHOWER HOSE</b> Threads directly on 1/2" NPSM male threaded personal hand held shower.</p>	<p>.002 Polished Chrome .224 Oil Rubbed Bronze .295 Satin Nickel (PVD) .243 Matte Black</p>
<p>8888.053</p>	<p><b>79" (2007MM) METAL SHOWER HOSE</b></p>	<p>.002 Polished Chrome</p>
<p>1660.400</p> 	<p><b>1/2" NPT IN-LINE VACUUM BREAKER</b> • Attaches between supply outlet and personal shower hose.</p>	<p>.002 Polished Chrome .224 Oil Rubbed Bronze .295 Satin Nickel (PVD)</p>
<p>1660.410</p> 	<p><b>SHOWER ARM DIVERTER</b> • Attaches to shower arm • Controls water flow between showerhead and hand held shower • 1/2" NPT connections</p>	<p>.002 Polished Chrome .295 Satin Nickel (PVD)</p>
<p>8888.096</p> 	<p><b>SHOWER ARM BRACKET</b> • Attaches to shower arm • Metal ball joint • Angle adjustable • 1/2" NPT connections</p>	<p>.002 Polished Chrome .224 Oil Rubbed Bronze .295 Satin Nickel (PVD)</p>

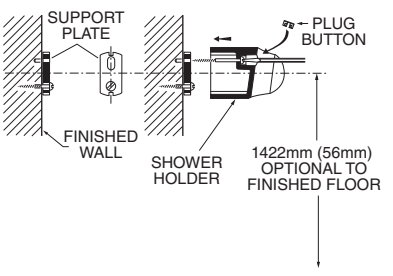
Model #	Description	Finishes	Rough-In Dimensions
<p><b>8888.037</b></p> 	<p><b>WALL SUPPLY</b></p> <ul style="list-style-type: none"> <li>• 1/2" NPT female thread</li> <li>• 1/2" NPSM male hose thread</li> </ul>	<p>.002 Polished Chrome .224 Oil Rubbed Bronze .295 Brushed Nickel .013 Polished Nickel .278 Legacy Bronze</p>	
<p><b>8888.068</b></p> 	<p><b>ROUND WALL SUPPLY</b></p> <ul style="list-style-type: none"> <li>• 1/2" NPT female thread</li> <li>• 1/2" NPSM male hose thread</li> <li>• Includes check valve</li> </ul>	<p>.002 Polished Chrome .295 Brushed Nickel</p>	
<p><b>8888.069</b></p> 	<p><b>SQUARE WALL SUPPLY</b></p> <ul style="list-style-type: none"> <li>• 1/2" NPT female thread</li> <li>• 1/2" NPSM male hose thread</li> <li>• Includes check valve</li> </ul>	<p>.002 Polished Chrome .295 Brushed Nickel .013 Polished Nickel .278 Legacy Bronze</p>	
<p><b>8888.036</b></p> 	<p><b>FIXTURE WALL BRACKET</b></p> <ul style="list-style-type: none"> <li>• For use with personal showers</li> </ul>	<p>.002 Polished Chrome .224 Oil Rubbed Bronze .295 Brushed Nickel .013 Polished Nickel .278 Legacy Bronze</p>	
<p><b>8888.038</b></p> 	<p><b>WALL SUPPLY BRACKET</b></p> <ul style="list-style-type: none"> <li>• 1/2" NPT female threads</li> <li>• Integral bracket holds the handshower at a convenient angle.</li> </ul>	<p>.002 Polished Chrome .224 Oil Rubbed Bronze .295 Brushed Nickel</p>	

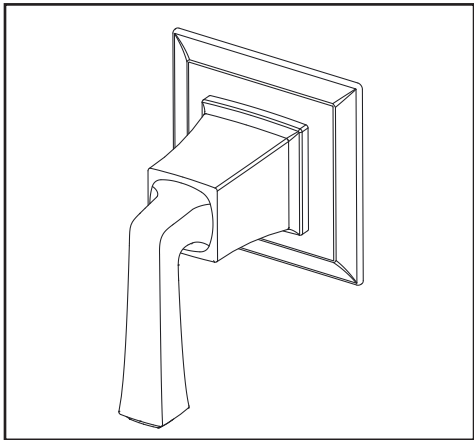

**MODEL NUMBER:**

**TRIM KIT:**

- ❑ **T455430 Diverter Valve Trim**  
Valve trim ONLY. LESS Valve.

**ROUGH VALVES BODIES:**

- ❑ **R422 Two-Way In-Wall Diverter Valve Rough (Discrete)**  
1/2" NPT inlets/outlets. 2 Discrete functions. LESS Handle.
- ❑ **R422S Two-Way In-Wall Diverter Valve Rough (Shared)**  
1/2" NPT inlets/outlets. 2 Discrete/1 Shared functions. LESS Handle.
- ❑ **R433 Three-Way In-Wall Diverter Valve Rough (Discrete)**  
1/2" NPT inlets/outlets. 3 Discrete functions. LESS Handle.
- ❑ **R433S Three-Way In-Wall Diverter Valve Rough (Shared)**  
1/2" NPT inlets/outlets. 3 Discrete/3 Shared functions. LESS Handle.

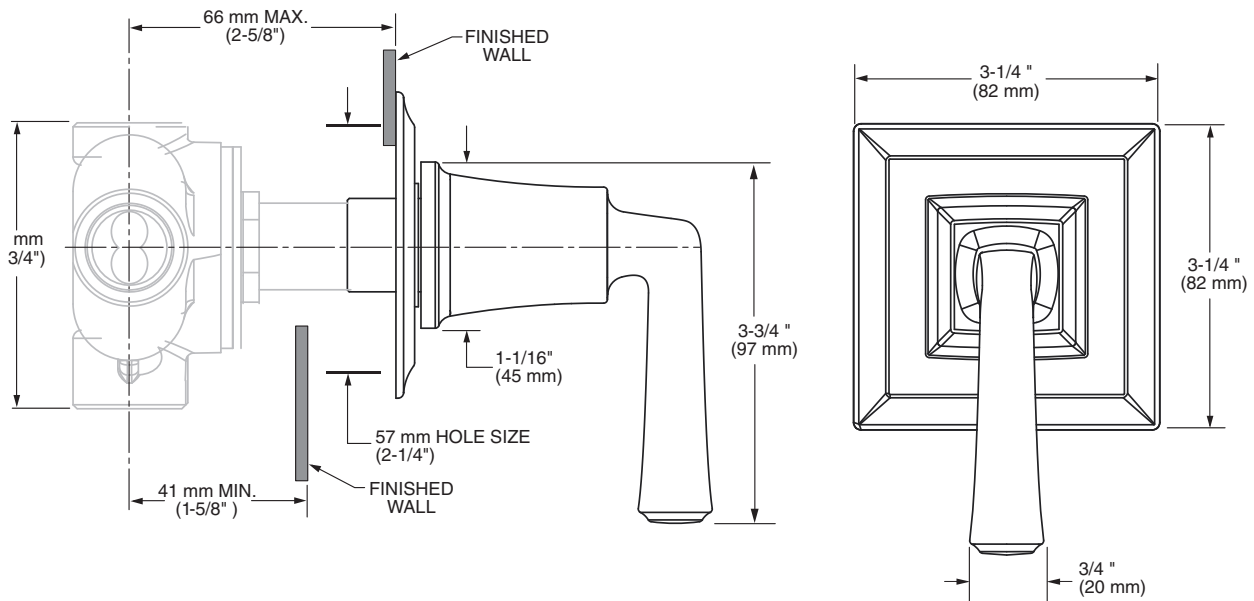

**GENERAL DESCRIPTION:**

In-Wall Diverter: Rotational control alternates water flow between two (R422/R422S) or three (R433/R433S) different shower outlets (i.e. showerhead, handspray, body side spray or tub spout). Forged brass valve body. Mixed water inlet and two (R422/R422S) or three (R433/R433S) outlets are marked on back of valve body. 1/2" NPT connections on mixed water inlet and two (R422/R422S) or three (R433/R433S) outlets. Stamped brass escutcheon. Tub port with increased water flow (see chart).

**PRODUCT FEATURES:**

- Solid Brass Construction:** Durable, ideal material for prolonged contact with water.
- Removable Plaster Guard:** Permits checking of valve installation prior to installing trim parts.

**NOTE:** Cannot be used as a shut-off valve.



ADA COMPLIANT

**SUGGESTED SPECIFICATION**

Two (three) way diverter shall feature a forged brass body with 1/2" NPT mixed water inlet and outlets. Fitting shall be American Standard Model # T455430.\_\_\_\_ (Diverter Valve Trim) and R4\_\_\_\_. (Rough Valve Body).

**CODES AND STANDARDS**

These products meet or exceed the following codes and standards:

**ASME A112.18.1**

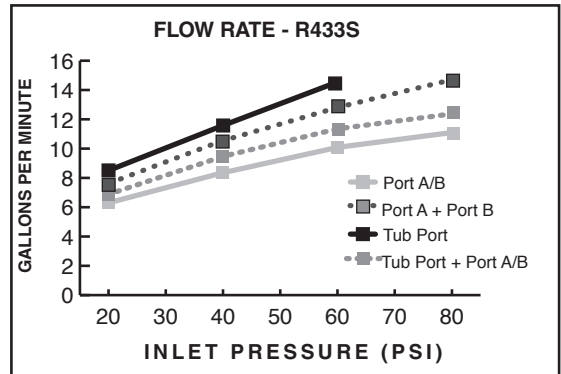
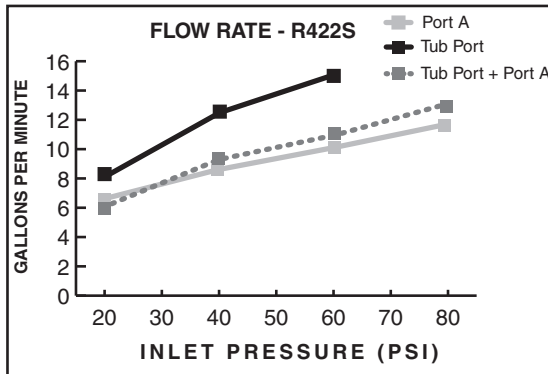
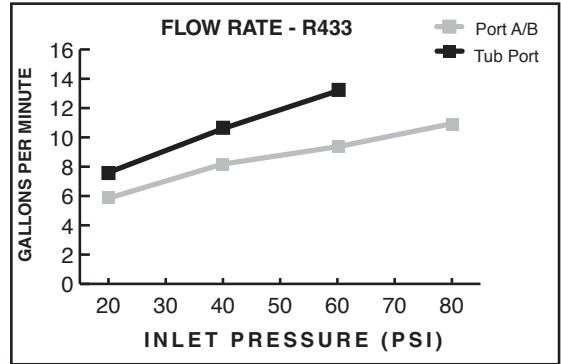
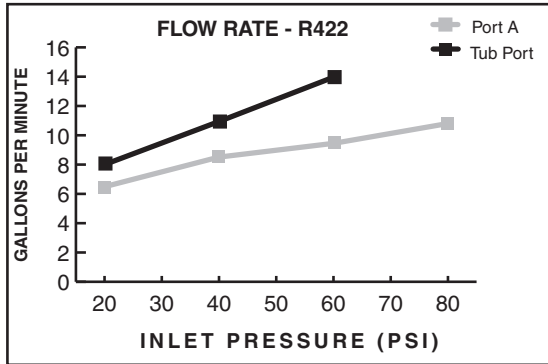

TRIM KITS *	Product Number	Description	Finish Options			
			Polished Chrome	PVD Brushed Nickel	Polished Nickel	Legacy Bronze
			002	295	013	278
T455430	Diverter Valve Trim. LESS valve.					

ROUGH VALVE BODIES	Product Number	Description
	R422*	Two-Way In-Wall Diverter. 2 Discrete functions. LESS handle.
	R422S*	Two-Way In-Wall Diverter. 2 Discrete/1 Shared functions. LESS handle.
	R433*	Three-Way In-Wall Diverter. 3 Discrete functions. LESS handle.
	R433S*	Three-Way In-Wall Diverter. 3 Discrete/3 Shared functions. LESS handle.

Meets the American Disabilities Act Guidelines and **ANSI A117.1** Requirements for the physically challenged.

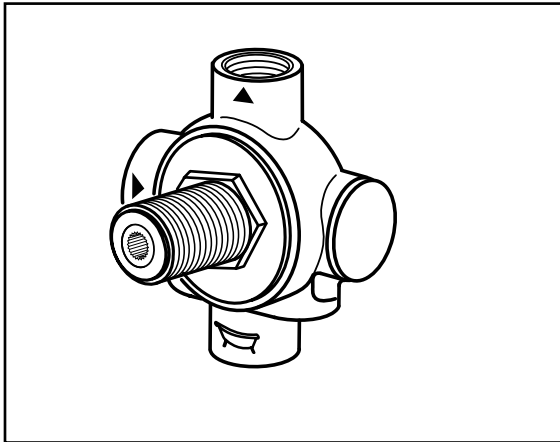

**MODEL NUMBER:**

- ❑ **R422 Two-Way In-Wall Diverter Valve Rough (Discrete)**  
1/2" NPT inlets/outlets. 2 Discrete functions. LESS Handle.
- ❑ **R422S Two-Way In-Wall Diverter Valve Rough (Shared)**  
1/2" NPT inlets/outlets. 2 Discrete/1 Shared functions. LESS Handle.

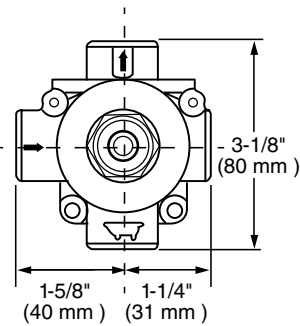
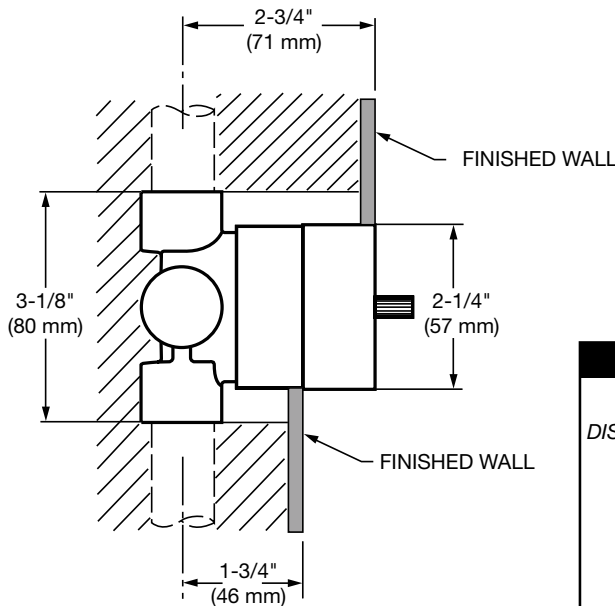

ALL CONNECTIONS 1/2" NPT

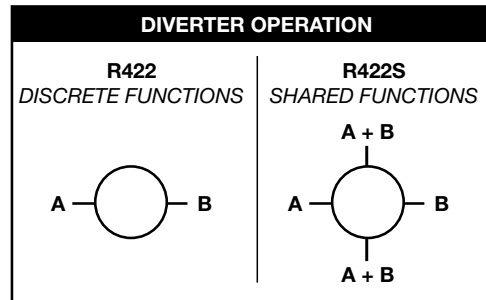

**GENERAL DESCRIPTION:**

In-Wall Diverter: Rotational control alternates water flow between two different shower outlets (i.e. showerhead, handspray, body side spray or tub spout). Forged brass valve body. Mixed water inlet and two outlets are marked on back of valve body. 1/2" NPT connections on mixed water inlet and two outlets. Stamped brass escutcheon. Tub port with increased water flow (see chart).

**NOTE:** Cannot be used as a shut-off valve.

**PRODUCT FEATURES:**

- Solid Brass Construction:** Durable, ideal material for prolonged contact with water.
- Removable Plaster Guard:** Permits checking of valve installation prior to installing trim parts.

**SUGGESTED SPECIFICATION**

Two way diverter shall feature a forged brass body with 1/2" NPT mixed water inlet and outlets. Fitting shall be American Standard Model # R422\_.

### CODES AND STANDARDS

These products meet or exceed the following codes and standards:

**ASME A112.18.1**  
**CSA B125.1**



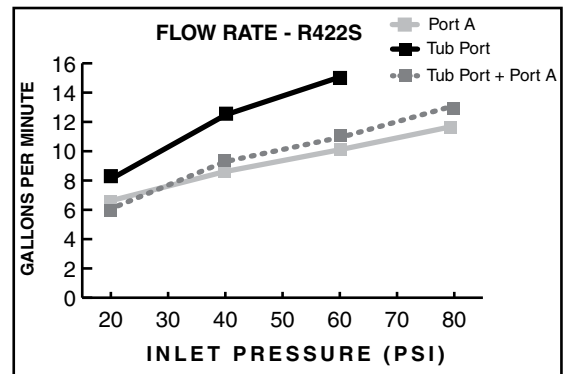
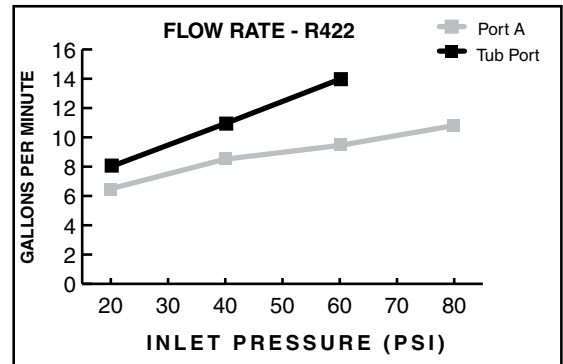











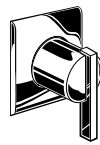
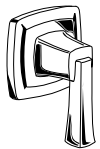



 Meets the American Disabilities Act Guidelines and **ANSI A117.1** Requirements for the physically challenged.



ROUGH VALVE BODIES	Product Number	Description
	R422*	Two-Way In-Wall Diverter. 2 Discrete functions. LESS handle.
	R422S*	Two-Way In-Wall Diverter. 2 Discrete/1 Shared functions. LESS handle.

\*Rough and Trim must be ordered separately.

R422 and R422S will accept the following handles:

AVAILABLE TRIM KITS	Town Square®	Serin®	Green Tea®	Moments®	Times Square®	Townsend®
						
	T555.430 	T064.430 	T010.430 	T506.430 	T184.430 	T353.430 
	Berwick®	Berwick®	Portsmouth®	Portsmouth®	Quentin®	
						
T430.430 	T430.432	T420.430 	T420.432	T440.430 