

Pressure Balance Bath/Shower Trim with Double Ceramic Pressure Balance Cartridge

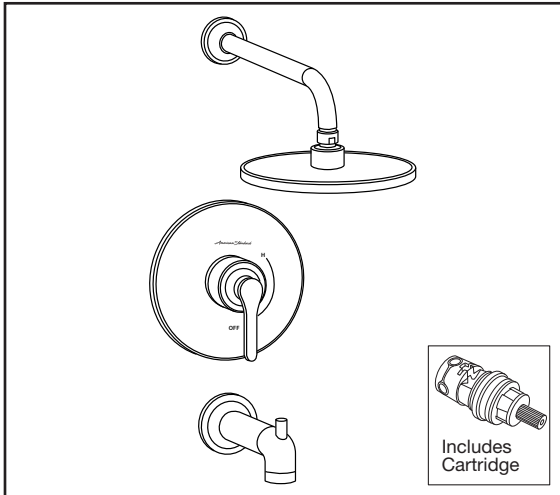

TU105502 Bath/Shower Trim Shown

GENERAL DESCRIPTION:

Double Ceramic Pressure Balance Cartridge: Features one-piece design with ceramic discs and ceramic balancing spool. Includes integrated check valves and hot limit safety stop. Cartridge is back to back capable. Ceramic balancing spool maintains constant output temperature in response to changes in relative hot and cold supply pressure. Washerless ceramic discs provide smooth handle movement and are unaffected by harsh water conditions.

Trim: Features 8" brass rain showerhead with a maximum 2.5 gpm/9.5 L/min. flow rate. Metal slip-on diverter spout. Metal wall valve trim with metal lever.

PRODUCT FEATURES

One-Piece Cartridge: Simplifies installation and maintenance.

Double Ceramic Pressure Balance Cartridge: Combination of Ceramic Disc Mixing Valve and a Ceramic Balancing Spool in a one-piece cartridge.

Ceramic Disc Mixing Valve: Assures a lifetime of drip-free performance and smooth handle operation.

Ceramic Balancing Spool: Maintains a constant output temperature in response to changes in relative hot and cold supply pressure. Ceramic material is unaffected by mineral deposits and harsh water conditions.

Integrated Check Valves: Engineered to eliminate cross flow.

Adjustable Hot Limit Safety Stop: Limits the amount of hot water allowed to mix with cold. Reduces the risk of accidental scalding.

Comfort Zone: Offers a wider shower range to fine tune the desired temperature within the useful temperature zone.

Back-to-Back Capability: Hot and cold can be reversed quickly and easily.

MODEL NUMBER:

TRIM KITS:

- ❑ TU105502 Studio S Bath/Shower Trim Kit with Pressure Balance Cartridge
Metal lever handle. LESS valve body.
- ❑ TU105501 Studio S Shower ONLY Trim Kit with Pressure Balance Cartridge
Metal lever handle. LESS valve body.
- ❑ TU105500 Studio S Valve ONLY Trim Kit with Pressure Balance Cartridge
Metal lever handle. LESS valve body.

For use with Flash™ Rough Valve Bodies

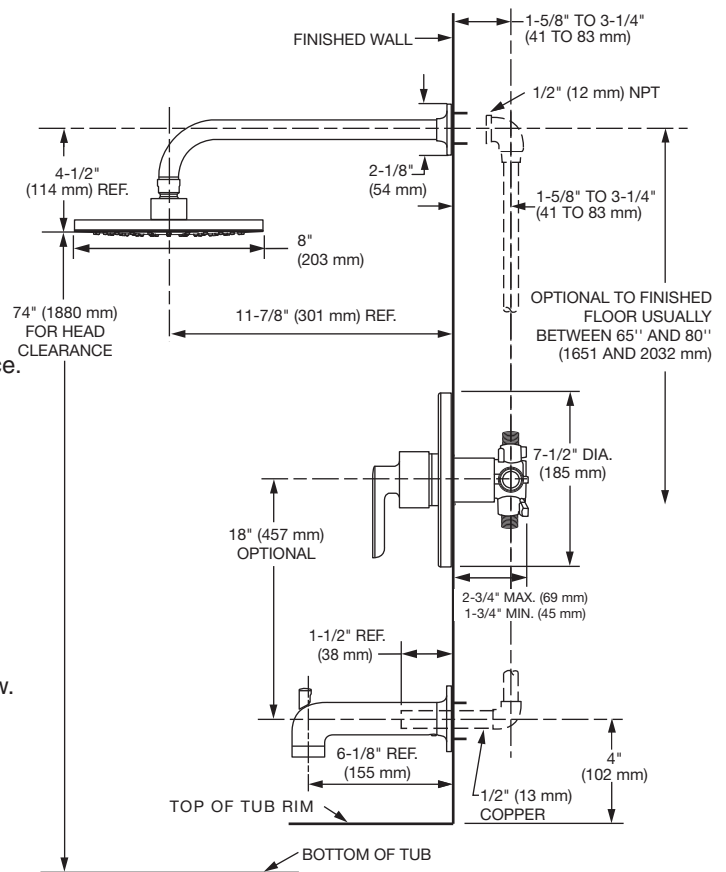

SUGGESTED SPECIFICATION

Bath/shower fitting shall feature brass rain showerhead with Max. 2.5 gpm/9.5 L/min. flow rate. Shall feature double ceramic pressure balance cartridge which is capable of back-to-back installation. Cartridge shall feature integrated check valves to eliminate cross flow. Capable of meeting ASSE1016 @1.3gpm. Cartridge shall also feature hot limit safety stop. Fitting shall be: American Standard - Trim Kit Model # TU18450_ and Flash Valve Body Model # RU10_.

CODES AND STANDARDS

These products meet or exceed the following codes and standards:

ASSE 1016 / ASME A112.18.1016 / CSA B125.16
ASME A112.18.1 / CSA B125.1
Rated to meet ASSE 1016 @ 1.3gpm

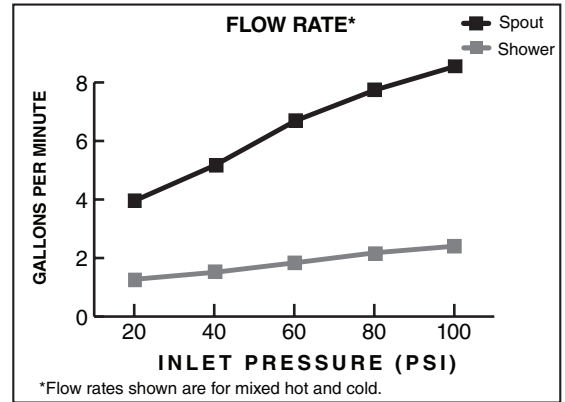

TRIM KITS*	Product Number	Description	Finish Options		
			Polished Chrome	Matte Black	PVD Brushed Nickel
			002	243	295
TU105502	Bath/Shower Trim Kit. Metal lever handle. Brass rain showerhead. LESS valve body.				
TU105501	Shower Only Trim Kit. Metal lever handle. Brass rain showerhead. LESS valve body.	ADA			
TU105500	Valve Only Trim Kit. Metal lever handle. LESS valve body.	ADA			

* TRIM & ROUGH MUST BE ORDERED SEPARATELY.

Flash™ ROUGH VALVE BODIES	Product Description	Without Screwdriver Stops	With Screwdriver Stops
		Rough Valve Body. Universal* inlets/outlets.	RU101
Rough Valve Body. Stub-out inlets/outlets for Press-Fit Fittings.	RU102	RU102SS	
Rough Valve Body. PEX inlets/Universal outlets for Crimp Ring PEX system (ASTM F1807).	RU107	RU107SS	
Rough Valve Body. PEX Elbow inlets/Universal outlets for Crimp Ring PEX system (ASTM F1807).	RU107E	RU107ESS	
Rough Valve Body. PEX inlets/Universal outlets for Cold Expansion PEX system (ASTM F1960).	RU108	RU108SS	
Rough Valve Body. PEX Elbow inlets/Universal outlets for Cold Expansion PEX system (ASTM F1960).	RU108E	RU108ESS	
Rough Valve Body. CPVC inlets/Universal outlets.	RU109	RU109SS	

OPTIONAL ACCESSORY	Product Number	Product Description
	M954805-0070A	Deep Rough-In Kit

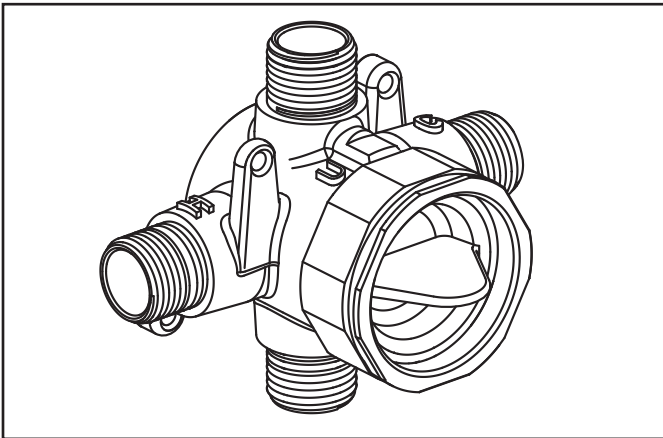

RU101 SHOWN

GENERAL DESCRIPTION:

Valve body features cast brass construction with a pre-installed test cap. Features back-to-back capability. One-half inch inlets and outlets (choice of Universal, PEX Crimp, PEX Cold Expansion, CPVC or Stub-outs). Features test cap with stainless steel retaining ring with flats. Available with screwdriver stops. Rough-in plaster guard designed as rough-in guide and for use as thin wall mounting support. For use with TU series trim kits with cartridges.

PRODUCT FEATURES:

Choice of Connections: Fast and easy installation without adaptors reducing leak points. Available connections include Universal (male thread/female sweat), PEX Crimp, PEX Cold expansion, CPVC, and Stub-outs.

Cast Brass Valve Body: Durable. Ideal material for prolonged contact with water.

Flat Back: Allows valve to be mounted flush against cross brace for easy and solid installation.

Test Cap: Allows valve body to be tested and flushed without the presence of the valve cartridge. Can be tested using test cap with air (200 psi) or water (300 psi).

Stainless Steel Retaining Ring with Flats: Secures test cap/cartridge in place and eliminates need for screws. Flats make it simple to loosen ring for quick, easy insertion/removal of test cap/cartridge.

Back-to-Back Capability: Hot and cold can be reversed quickly and easily.

Exclusive Plaster Guard: Plaster guard is designed to protect valve and act as a guide during installation. It can serve as mounting support for thin-wall installations.

Wide Rough-in Range: From 1-3/4" to 2-3/4" from finished wall to the back of the valve.

MODEL NUMBERS:

- RU101 Flash Rough Valve Body with Flash Connections**
1/2" Universal inlets/outlets.
- RU101SS Flash Rough Valve Body with Flash Connections with Screwdriver Stops**
1/2" Universal inlets/outlets.
- RU102 Flash Rough Valve Body with Stub-Out Connections**
1/2" Stub-out inlets/outlets.
- RU102SS Flash Rough Valve Body with Stub-Out Connections with Screwdriver Stops**
1/2" Stub-out inlets/outlets.
- RU107 Flash Rough Valve Body with PEX Crimp Connections**
1/2" PEX Crimp inlets (ASTM F1807) / Universal outlets.
- RU107SS Flash Rough Valve Body with PEX Crimp Connections with Screwdriver Stops**
1/2" PEX Crimp inlets (ASTM F1807) / Universal outlets.
- RU107E Flash Rough Valve Body with PEX Crimp Elbow Connections**
1/2" PEX Crimp Elbow inlets (ASTM F1807) / Universal outlets.
- RU107ESS Flash Rough Valve Body with PEX Crimp Elbow Connections with Screwdriver Stops**
1/2" PEX Crimp Elbow inlets (ASTM F1807) / Universal outlets.
- RU108 Flash Rough Valve Body with PEX Cold Expansion Connections**
1/2" PEX Cold Expansion inlets (ASTM F1960) / Universal outlets.
- RU108SS Flash Rough Valve Body with PEX Cold Expansion Connections with Screwdriver Stops**
1/2" PEX Cold Expansion inlets (ASTM F1960) / Universal outlets.
- RU108E Flash Rough Valve Body with PEX Cold Expansion Elbow Connections**
1/2" PEX Cold Expansion Elbow inlets (ASTM F1960) / Universal outlets.
- RU108ESS Flash Rough Valve Body with PEX Cold Expansion Elbow Connections with Screwdriver Stops**
1/2" PEX Cold Expansion Elbow inlets (ASTM F1960) / Universal outlets.
- RU109 Flash Rough Valve Body with CPVC Connections**
1/2" CPVC inlets / Universal outlets.
- RU1098SS Flash Rough Valve Body with CPVC Connections with Screwdriver Stops**
1/2" CPVC inlets / Universal outlets.

SUGGESTED SPECIFICATION

Rough Valve Body shall feature a cast brass body. Shall feature back-to-back capability. Valve Body shall feature test cap to flush and test the lines. Shall feature stainless steel retaining ring with flats. Rough Valve Body shall be: Rough Valve Body - American Standard Model # RU10____.

UNIVERSAL	
<p>RU101</p> <p>INLETS ½" NOM. COPPER SWEAT or ½" MALE NPT</p> <p>OUTLETS ½" NOM. COPPER SWEAT or ½" MALE NPT</p>	<p>RU101SS</p> <p>INLETS ½" NOM. COPPER SWEAT or ½" MALE NPT</p> <p>OUTLETS ½" NOM. COPPER SWEAT or ½" MALE NPT</p>
STUB-OUT FOR PRESS-CONNECT FITTINGS	
<p>RU102</p> <p>INLETS ½" STUB OUT</p> <p>OUTLETS ½" STUB OUT</p>	<p>RU102SS</p> <p>INLETS ½" STUB OUT</p> <p>OUTLETS ½" STUB OUT</p>
PEX-CRIMP	
<p>RU107</p> <p>INLETS ½" PEX (ASTM F1807-2)</p> <p>OUTLETS ½" NOM. COPPER SWEAT or ½" MALE NPT</p>	<p>RU107SS</p> <p>INLETS SWEAT or ½" PEX (ASTM F1807-2)</p> <p>OUTLETS ½" NOM. COPPER SWEAT or ½" MALE NPT</p>
<p>RU107E</p> <p>INLETS ½" PEX (ASTM F1960)</p> <p>OUTLETS ½" NOM. COPPER SWEAT or ½" MALE NPT</p> <p><i>Valve can be rotated 180° for ceiling mount supply lines</i></p>	<p>RU107ESS</p> <p>INLETS ½" PEX (ASTM F1960)</p> <p>OUTLETS ½" NOM. COPPER SWEAT or ½" MALE NPT</p> <p><i>Valve can be rotated 180° for ceiling mount supply lines</i></p>
PEX-COLD EXPANSION	
<p>RU108</p> <p>INLETS ½" PEX (ASTM F1960)</p> <p>OUTLETS ½" NOM. COPPER SWEAT or ½" MALE NPT</p>	<p>RU108SS</p> <p>INLETS ½" PEX (ASTM F1960)</p> <p>OUTLETS ½" NOM. COPPER SWEAT or ½" MALE NPT</p>
<p>RU108E</p> <p>INLETS ½" PEX (ASTM F1960)</p> <p>OUTLETS ½" NOM. COPPER SWEAT or ½" MALE NPT</p> <p><i>Valve can be rotated 180° for ceiling mount supply lines</i></p>	<p>RU108ESS</p> <p>INLETS ½" PEX (ASTM F1960)</p> <p>OUTLETS ½" NOM. COPPER SWEAT or ½" MALE NPT</p> <p><i>Valve can be rotated 180° for ceiling mount supply lines</i></p>
CPVC	
<p>RU109</p> <p>INLETS ½" NOM CPVC</p> <p>OUTLETS ½" NOM. COPPER SWEAT or ½" MALE NPT</p>	<p>RU109SS</p> <p>INLETS ½" NOM CPVC</p> <p>OUTLETS ½" NOM. COPPER SWEAT or ½" MALE NPT</p>

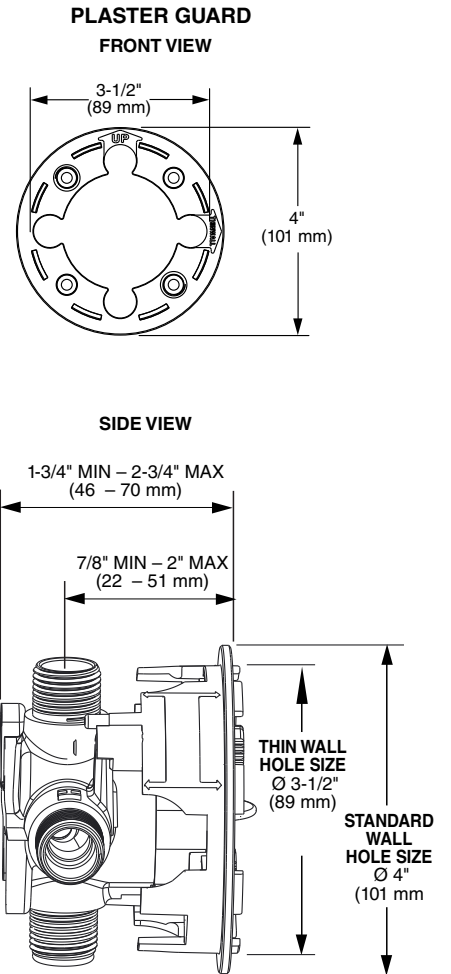

NOTE: TO AVOID SHOWER RISE OR OTHER RELATED ISSUES, DO NOT USE PEX CONNECTIONS ON ANY OF THE OUTLETS.



CODES AND STANDARDS

These products meet or exceed the following codes and standards:

ASSE 1016 / ASME A112.18.1016 / CSA B125.16

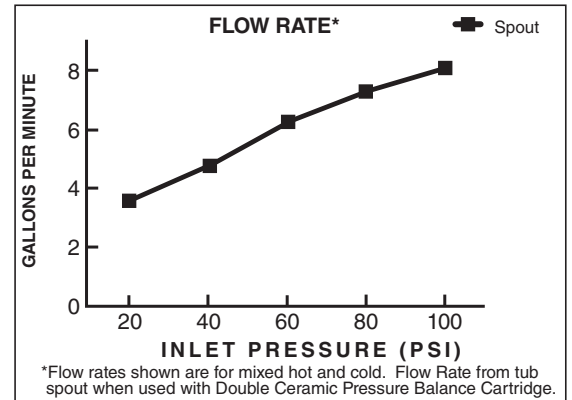
ASME A112.18.1 / CSA B125.1

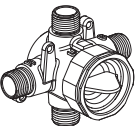
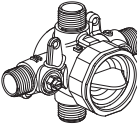
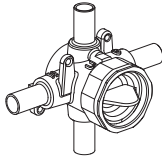
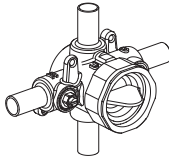

UNIVERSAL		STUB-OUT FOR PRESS-CONNECT FITTINGS		CPVC	
RU101	RU101SS	RU102	RU102SS	RU109	RU109SS
					
½" Universal Inlets/ Outlets	½" Universal Inlets/ Outlets	½" Stub-Out Inlets/ Outlets	½" Stub-Out Inlets/ Outlets	½" CPVC Inlets/ Universal Outlets	½" CPVC Inlets/ Universal Outlets
	Screwdriver Stops		Screwdriver Stops		Screwdriver Stops

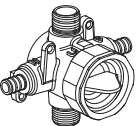
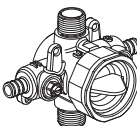
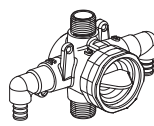
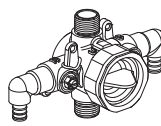
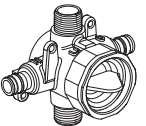
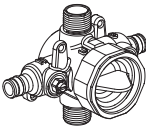
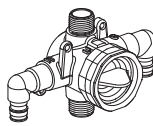
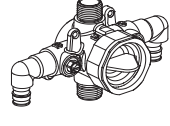
PEX - CRIMP (ASTM F1807)				PEX - COLD EXPANSION (ASTM 1960)			
RU107	RU107SS	RU107E	RU107ESS	RU108	RU108SS	RU108E	RU108ESS
							
½" PEX Crimp Inlets/ Flash Outlets	½" PEX Crimp Inlets/ Universal Outlets	½" PEX Crimp Elbow Inlets/ Universal Outlets	½" PEX Crimp Elbow Inlets/ Universal Outlets	½" PEX Cold Expansion Inlets/ Universal Outlets	½" PEX Cold Expansion Inlets/ Universal Outlets	½" PEX Cold Expansion Elbow Inlets/ Universal Outlets	½" PEX Cold Expansion Elbow Inlets/ Universal Outlets
	Screwdriver Stops		Screwdriver Stops		Screwdriver Stops		Screwdriver Stops

*Universal = Male IPS Thread/Female Sweat

OPTIONAL ACCESSORIES	
M954334-0070A	Flush Plug
M954805-0070A	Deep Rough-in Kit

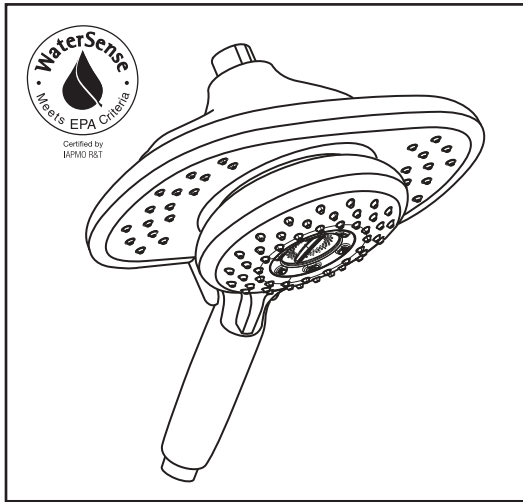

MODEL NUMBER:

□ 9038.254 Spectra+ Duo™ 4-Function 2-in-1 Showerhead

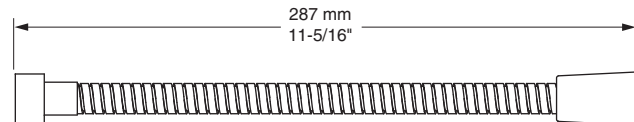
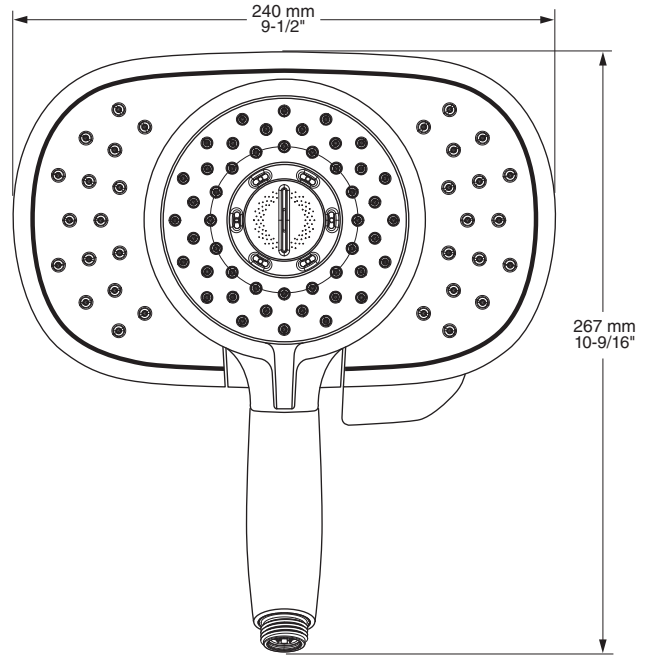
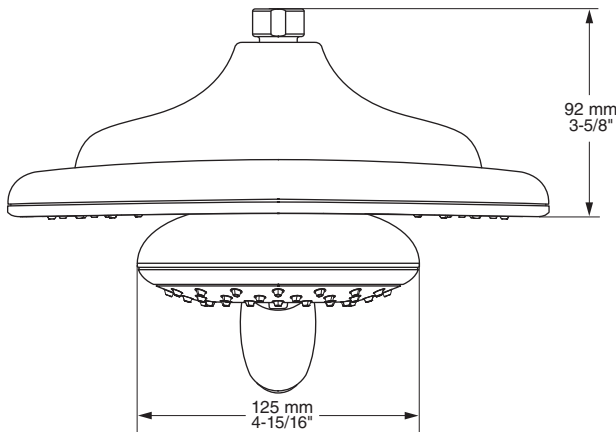

GENERAL DESCRIPTION:

2-in-1 Showerhead adjusts from Drench to Sensitive to Powerwash® to Massage. Permanent built-in compensating flow control device. 1.8 gpm/6.8 L/min. maximum flow rate.

PRODUCT FEATURES:

Water Saving: WaterSense certified.

Pressure Compensating Flow Control Device: Provides consistent flow over a wide pressure range.

Variety of Spray Functions: Allows the user to select the spray function best suited to their needs.

SUGGESTED SPECIFICATION

2-in-1 Showerhead shall have 4 spray functions. 2-in-1 shall have a pressure compensating flow control device and check valve to prevent cross flow of hot and cold water. Fitting shall be American Standard Model # 9038.254.____.



CODES AND STANDARDS



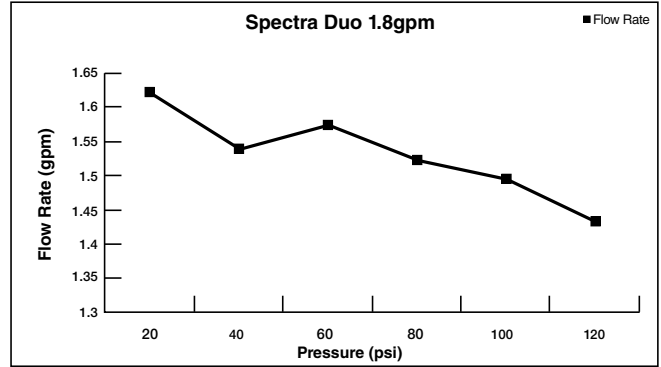







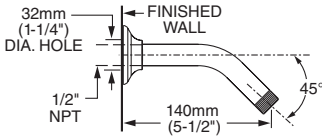

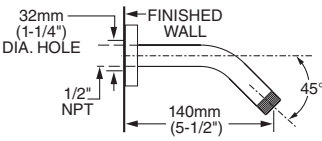

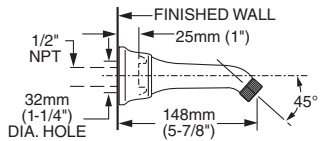

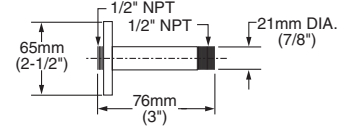

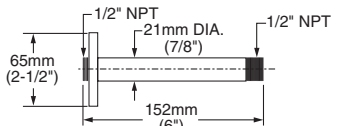
These products meet or exceed the following codes and standards:

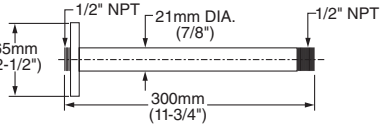
- ASME A112.18.1**
- CSA B125.1**
- EPA WaterSense**

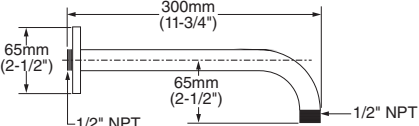

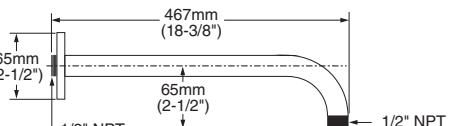
Product Number	Description	Finish Options			
		Polished Chrome	Brushed Nickel	Polished Nickel (PVD)	Legacy Bronze
		002	295	013	278
9038.254	Spectra+ Duo™ 4-Function 2-in-1 Showerhead.				

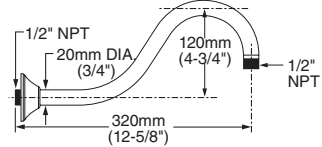
Showerhead Accessories	
Product Number	Description
1660.240	Standard Shower Arm and Flange 
1660.241	Modern Shower Arm and Flange 

Model #	Description	Finishes	Roughing-In Dimensions
SHOWER ARMS			
1660.240 	STANDARD SHOWER ARM • Brass construction • 1/2" NPT Thread	.002 Polished Chrome .224 Oil Rubbed Bronze .295 Satin Nickel (PVD)	
1660.241 	MODERN SHOWER ARM • Brass construction • 1/2" NPT Thread	.002 Polished Chrome .295 Satin Nickel (PVD)	
1660.242 	SQUARE SHOWER ARM • Cast brass • 1/2" NPT Thread	.002 Polished Chrome .224 Oil Rubbed Bronze .295 Satin Nickel (PVD)	
RAIN SHOWER ARMS			
1660.103 	3" CEILING MOUNT SHOWER ARM • Brass construction • 1/2" NPT Thread	.002 Polished Chrome .295 Satin Nickel (PVD)	
1660.186 	6" CEILING MOUNT SHOWER ARM • Brass construction • 1/2" NPT Thread	.002 Polished Chrome .295 Satin Nickel (PVD)	
1660.190 	12" CEILING MOUNT SHOWER ARM • Brass construction • 1/2" NPT Thread	.002 Polished Chrome .224 Oil Rubbed Bronze .295 Satin Nickel (PVD)	
1660.194 	12" WALL MOUNT RIGHT ANGLE SHOWER ARM • Brass construction • 1/2" NPT Thread	.002 Polished Chrome .224 Oil Rubbed Bronze .295 Satin Nickel (PVD)	
1660.118 	18" WALL MOUNT RIGHT ANGLE SHOWER ARM • Brass construction • 1/2" NPT Thread	.002 Polished Chrome .295 Satin Nickel (PVD)	
1660.198 	12" WALL MOUNT SHEPHERD'S CROOK SHOWER ARM • Brass construction • 1/2" NPT Thread	.002 Polished Chrome .224 Oil Rubbed Bronze .295 Satin Nickel (PVD)	
SHOWER ARM ACCESSORIES			
1660.191 	SQUARE SHOWER FLANGE • Brass construction • For use with: 1660.240 1660.241 1660.190 1660.194	.002 Polished Chrome .295 Satin Nickel (PVD)	