

TU184508 Bath/Shower Trim Shown

GENERAL DESCRIPTION:

Double Ceramic Pressure Balance Cartridge: Features one-piece design with ceramic discs and ceramic balancing spool. Includes integrated check valves and hot limit safety stop. Cartridge is back to back capable. Ceramic balancing spool maintains constant output temperature in response to changes in relative hot and cold supply pressure. Washerless ceramic discs provide smooth handle movement and are unaffected by harsh water conditions. Cycles from "off" to "cold" to "hot".

Trim: Features water-saving 5" 3-function showerhead with a maximum 1.75 gpm/6.6 L/min. flow rate. Metal slip-on diverter spout. Metal wall valve trim with metal lever.

PRODUCT FEATURES

One-Piece Cartridge: Simplifies installation and maintenance.

Double Ceramic Pressure Balance Cartridge: Combination of Ceramic Disc Mixing Valve and a Ceramic Balancing Spool in a one-piece cartridge.

Ceramic Disc Mixing Valve: Assures a lifetime of drip-free performance and smooth handle operation.

Ceramic Balancing Spool: Maintains a constant output temperature in response to changes in relative hot and cold supply pressure. Ceramic material is unaffected by mineral deposits and harsh water conditions.

Integrated Check Valves: Engineered to eliminate cross flow.

Adjustable Hot Limit Safety Stop: Limits the amount of hot water allowed to mix with cold. Reduces the risk of accidental scalding.

Comfort Zone: Offers a wider shower range to fine tune the desired temperature within the useful temperature zone

Back-to-Back Capability: Hot and cold can be reversed quickly and easily.

Water Saving: Saves 30% water usage.

MODEL NUMBER:

TRIM KITS:

- TU722508 Estate Bath/Shower Trim Kit with Pressure Balance Cartridge**
Lever handle. Water-saving showerhead. LESS valve body.
- TU722507 Estate Shower ONLY Trim Kit with Pressure Balance Cartridge**
Lever handle. Water-saving showerhead. LESS valve body.

For use with Flash™ Rough Valve Bodies

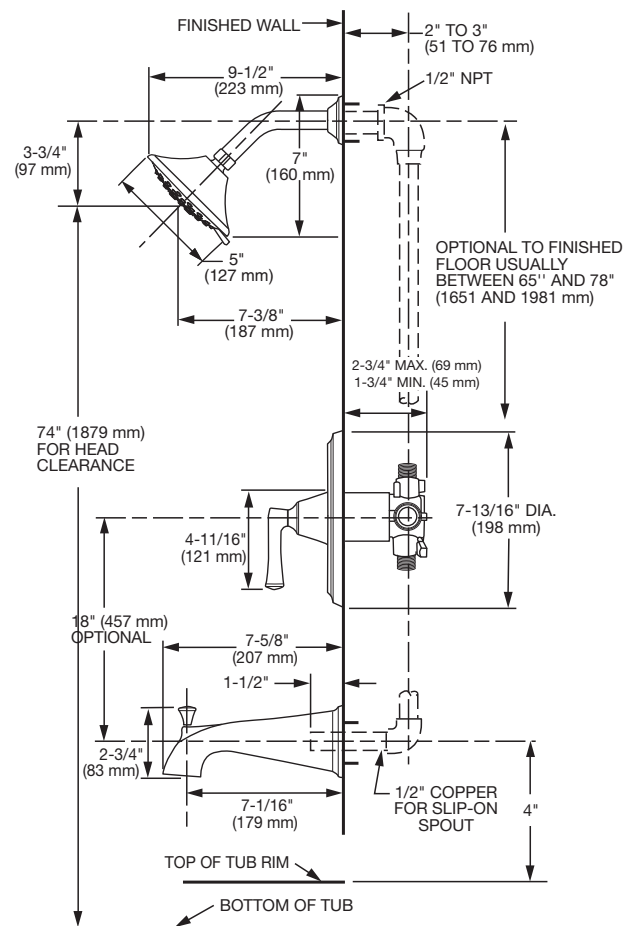

SUGGESTED SPECIFICATION

Bath/shower fitting shall feature water saving 3-function showerhead with Max. 1.75 gpm/6.6 L/min. flow rate. Shall feature double ceramic pressure balance cartridge which is capable of back-to-back installation. Cartridge shall feature integrated check valves to eliminate cross flow. Capable of meeting ASSE1016 @1.3gpm. Cartridge shall also feature hot limit safety stop. Fitting shall be: American Standard - Trim Kit Model # TU72250_ and Flash Valve Body Model # RU10_.



Estate®

Water-Saving Pressure Balance Bath/Shower Trim with Double Ceramic Pressure Balance Cartridge

CODES AND STANDARDS

These products meet or exceed the following codes and standards:

ASSE 1016 / ASME A112.18.1016 / CSA B125.16
ASME A112.18.1 / CSA B125.1
Rated to meet ASSE 1016 @ 1.3gpm

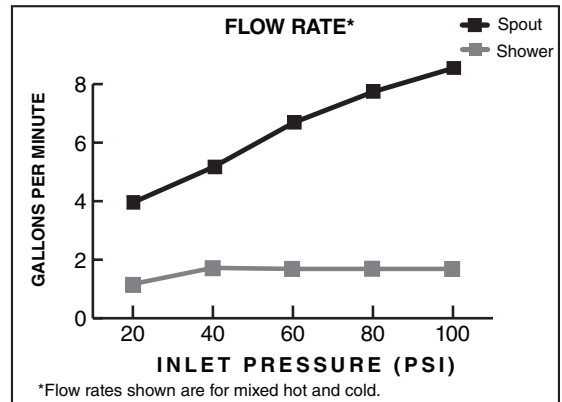

TRIM KITS *	Product Number	Description	Finish Options	
			Polished Chrome	PVD Brushed Nickel
			002	295
TU722508	Bath/Shower Trim Kit. Metal lever handle. Water-saving showerhead. LESS valve body.			
TU722507	Shower Only Trim Kit. Metal lever handle. Water-saving showerhead. LESS valve body.			

* TRIM & ROUGH MUST BE ORDERED SEPARATELY.

Flash™ ROUGH VALVE BODIES	Product Description	Without Screwdriver Stops	With Screwdriver Stops
	Rough Valve Body. Universal* inlets/outlets.	RU101	RU101SS
	Rough Valve Body. Stub-out inlets/outlets for Press-Fit Fittings.	RU102	RU102SS
	Rough Valve Body. PEX inlets/Universal outlets for Crimp Ring PEX system (ASTM F1807).	RU107	RU107SS
	Rough Valve Body. PEX Elbow inlets/Universal outlets for Crimp Ring PEX system (ASTM F1807).	RU107E	RU107ESS
	Rough Valve Body. PEX inlets/Universal outlets for Cold Expansion PEX system (ASTM F1960).	RU108	RU108SS
	Rough Valve Body. PEX Elbow inlets/Universal outlets for Cold Expansion PEX system (ASTM F1960).	RU108E	RU108ESS
	Rough Valve Body. CPVC inlets/Universal outlets.	RU109	RU109SS

OPTIONAL ACCESSORY	Product Number	Product Description
	M954805-0070A	Deep Rough-In Kit

Meets the American Disabilities Act Guidelines and **ANSI A117.1** Requirements for the physically challenged.

PART OF **LIXIL**

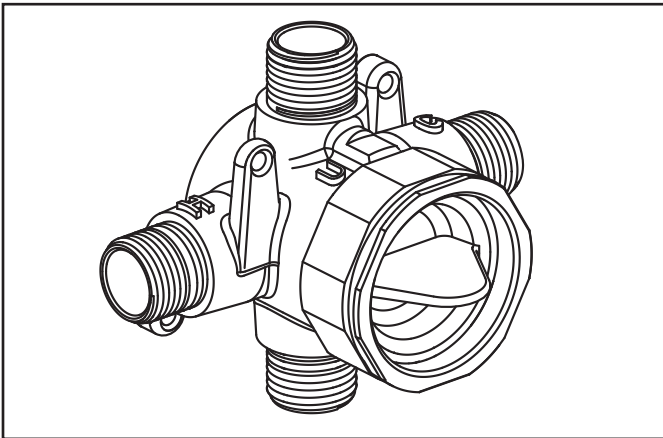

RU101 SHOWN

GENERAL DESCRIPTION:

Valve body features cast brass construction with a pre-installed test cap. Features back-to-back capability. One-half inch inlets and outlets (choice of Universal, PEX Crimp, PEX Cold Expansion, CPVC or Stub-outs). Features test cap with stainless steel retaining ring with flats. Available with screwdriver stops. Rough-in plaster guard designed as rough-in guide and for use as thin wall mounting support. For use with TU series trim kits with cartridges.

PRODUCT FEATURES:

Choice of Connections: Fast and easy installation without adaptors reducing leak points. Available connections include Universal (male thread/female sweat), PEX Crimp, PEX Cold expansion, CPVC, and Stub-outs.

Cast Brass Valve Body: Durable. Ideal material for prolonged contact with water.

Flat Back: Allows valve to be mounted flush against cross brace for easy and solid installation.

Test Cap: Allows valve body to be tested and flushed without the presence of the valve cartridge. Can be tested using test cap with air (200 psi) or water (300 psi).

Stainless Steel Retaining Ring with Flats: Secures test cap/cartridge in place and eliminates need for screws. Flats make it simple to loosen ring for quick, easy insertion/removal of test cap/cartridge.

Back-to-Back Capability: Hot and cold can be reversed quickly and easily.

Exclusive Plaster Guard: Plaster guard is designed to protect valve and act as a guide during installation. It can serve as mounting support for thin-wall installations.

Wide Rough-in Range: From 1-3/4" to 2-3/4" from finished wall to the back of the valve.

MODEL NUMBERS:

- RU101 Flash Rough Valve Body with Flash Connections**
1/2" Universal inlets/outlets.
- RU101SS Flash Rough Valve Body with Flash Connections with Screwdriver Stops**
1/2" Universal inlets/outlets.
- RU102 Flash Rough Valve Body with Stub-Out Connections**
1/2" Stub-out inlets/outlets.
- RU102SS Flash Rough Valve Body with Stub-Out Connections with Screwdriver Stops**
1/2" Stub-out inlets/outlets.
- RU107 Flash Rough Valve Body with PEX Crimp Connections**
1/2" PEX Crimp inlets (ASTM F1807) / Universal outlets.
- RU107SS Flash Rough Valve Body with PEX Crimp Connections with Screwdriver Stops**
1/2" PEX Crimp inlets (ASTM F1807) / Universal outlets.
- RU107E Flash Rough Valve Body with PEX Crimp Elbow Connections**
1/2" PEX Crimp Elbow inlets (ASTM F1807) / Universal outlets.
- RU107ESS Flash Rough Valve Body with PEX Crimp Elbow Connections with Screwdriver Stops**
1/2" PEX Crimp Elbow inlets (ASTM F1807) / Universal outlets.
- RU108 Flash Rough Valve Body with PEX Cold Expansion Connections**
1/2" PEX Cold Expansion inlets (ASTM F1960) / Universal outlets.
- RU108SS Flash Rough Valve Body with PEX Cold Expansion Connections with Screwdriver Stops**
1/2" PEX Cold Expansion inlets (ASTM F1960) / Universal outlets.
- RU108E Flash Rough Valve Body with PEX Cold Expansion Elbow Connections**
1/2" PEX Cold Expansion Elbow inlets (ASTM F1960) / Universal outlets.
- RU108ESS Flash Rough Valve Body with PEX Cold Expansion Elbow Connections with Screwdriver Stops**
1/2" PEX Cold Expansion Elbow inlets (ASTM F1960) / Universal outlets.
- RU109 Flash Rough Valve Body with CPVC Connections**
1/2" CPVC inlets / Universal outlets.
- RU1098SS Flash Rough Valve Body with CPVC Connections with Screwdriver Stops**
1/2" CPVC inlets / Universal outlets.

SUGGESTED SPECIFICATION

Rough Valve Body shall feature a cast brass body. Shall feature back-to-back capability. Valve Body shall feature test cap to flush and test the lines. Shall feature stainless steel retaining ring with flats. Rough Valve Body shall be: Rough Valve Body - American Standard Model # RU10____.

UNIVERSAL	
<p>RU101</p> <p>INLETS ½" NOM. COPPER SWEAT or ½" MALE NPT</p> <p>OUTLETS ½" NOM. COPPER SWEAT or ½" MALE NPT</p>	<p>RU101SS</p> <p>INLETS ½" NOM. COPPER SWEAT or ½" MALE NPT</p> <p>OUTLETS ½" NOM. COPPER SWEAT or ½" MALE NPT</p>
STUB-OUT FOR PRESS-CONNECT FITTINGS	
<p>RU102</p> <p>INLETS ½" STUB OUT</p> <p>OUTLETS ½" STUB OUT</p>	<p>RU102SS</p> <p>INLETS ½" STUB OUT</p> <p>OUTLETS ½" STUB OUT</p>
PEX-CRIMP	
<p>RU107</p> <p>INLETS ½" PEX (ASTM F1807-2)</p> <p>OUTLETS ½" NOM. COPPER SWEAT or ½" MALE NPT</p>	<p>RU107SS</p> <p>INLETS SWEAT or ½" PEX (ASTM F1807-2)</p> <p>OUTLETS ½" NOM. COPPER SWEAT or ½" MALE NPT</p>
<p>RU107E</p> <p>INLETS ½" PEX (ASTM F1960)</p> <p>OUTLETS ½" NOM. COPPER SWEAT or ½" MALE NPT</p> <p><i>Valve can be rotated 180° for ceiling mount supply lines</i></p>	<p>RU107ESS</p> <p>INLETS ½" PEX (ASTM F1960)</p> <p>OUTLETS ½" NOM. COPPER SWEAT or ½" MALE NPT</p> <p><i>Valve can be rotated 180° for ceiling mount supply lines</i></p>
PEX-COLD EXPANSION	
<p>RU108</p> <p>INLETS ½" PEX (ASTM F1960)</p> <p>OUTLETS ½" NOM. COPPER SWEAT or ½" MALE NPT</p>	<p>RU108SS</p> <p>INLETS ½" PEX (ASTM F1960)</p> <p>OUTLETS ½" NOM. COPPER SWEAT or ½" MALE NPT</p>
<p>RU108E</p> <p>INLETS ½" PEX (ASTM F1960)</p> <p>OUTLETS ½" NOM. COPPER SWEAT or ½" MALE NPT</p> <p><i>Valve can be rotated 180° for ceiling mount supply lines</i></p>	<p>RU108ESS</p> <p>INLETS ½" PEX (ASTM F1960)</p> <p>OUTLETS ½" NOM. COPPER SWEAT or ½" MALE NPT</p> <p><i>Valve can be rotated 180° for ceiling mount supply lines</i></p>
CPVC	
<p>RU109</p> <p>INLETS ½" NOM CPVC</p> <p>OUTLETS ½" NOM. COPPER SWEAT or ½" MALE NPT</p>	<p>RU109SS</p> <p>INLETS ½" NOM CPVC</p> <p>OUTLETS ½" NOM. COPPER SWEAT or ½" MALE NPT</p>

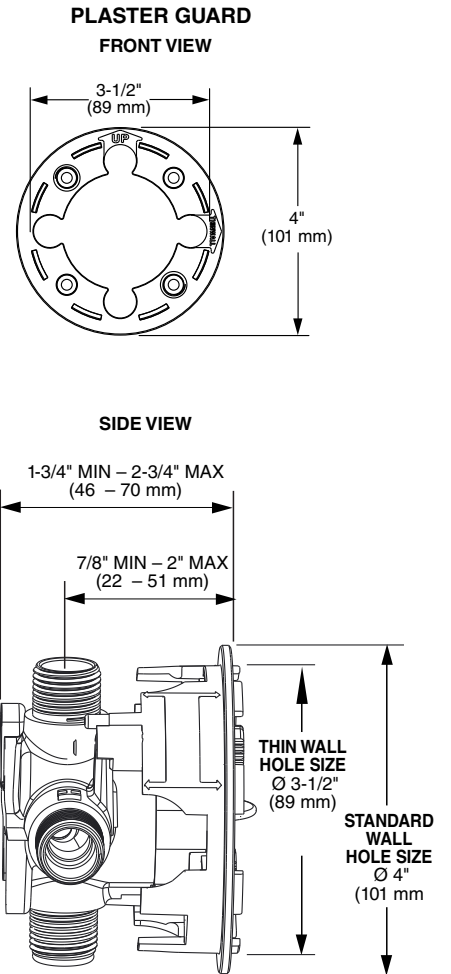

NOTE: TO AVOID SHOWER RISE OR OTHER RELATED ISSUES, **DO NOT** USE PEX CONNECTIONS ON ANY OF THE OUTLETS.



CODES AND STANDARDS

These products meet or exceed the following codes and standards:

ASSE 1016 / ASME A112.18.1016 / CSA B125.16

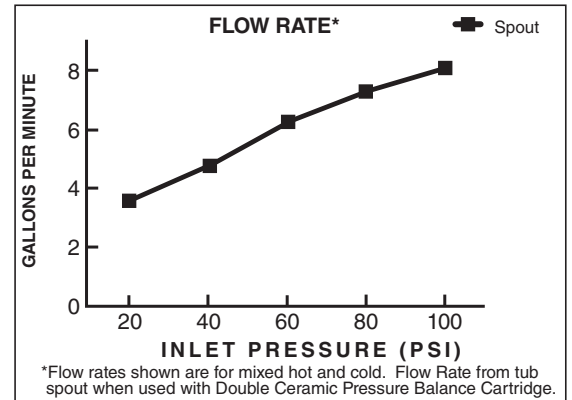
ASME A112.18.1 / CSA B125.1

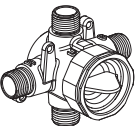
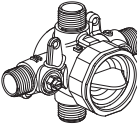
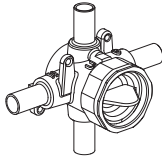
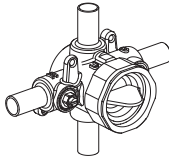

UNIVERSAL		STUB-OUT FOR PRESS-CONNECT FITTINGS		CPVC	
RU101	RU101SS	RU102	RU102SS	RU109	RU109SS
					
½" Universal Inlets/ Outlets	½" Universal Inlets/ Outlets	½" Stub-Out Inlets/ Outlets	½" Stub-Out Inlets/ Outlets	½" CPVC Inlets/ Universal Outlets	½" CPVC Inlets/ Universal Outlets
	Screwdriver Stops		Screwdriver Stops		Screwdriver Stops

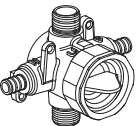
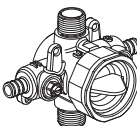
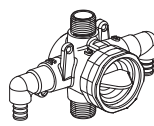
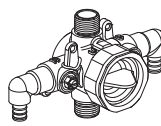
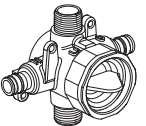
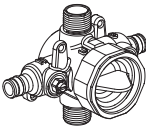
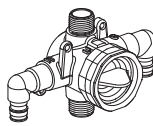
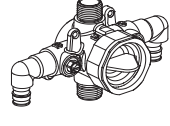
PEX - CRIMP (ASTM F1807)				PEX - COLD EXPANSION (ASTM 1960)			
RU107	RU107SS	RU107E	RU107ESS	RU108	RU108SS	RU108E	RU108ESS
							
½" PEX Crimp Inlets/ Flash Outlets	½" PEX Crimp Inlets/ Universal Outlets	½" PEX Crimp Elbow Inlets/ Universal Outlets	½" PEX Crimp Elbow Inlets/ Universal Outlets	½" PEX Cold Expansion Inlets/ Universal Outlets	½" PEX Cold Expansion Inlets/ Universal Outlets	½" PEX Cold Expansion Elbow Inlets/ Universal Outlets	½" PEX Cold Expansion Elbow Inlets/ Universal Outlets
	Screwdriver Stops		Screwdriver Stops		Screwdriver Stops		Screwdriver Stops

*Universal = Male IPS Thread/Female Sweat

OPTIONAL ACCESSORIES	
M954334-0070A	Flush Plug
M954805-0070A	Deep Rough-in Kit

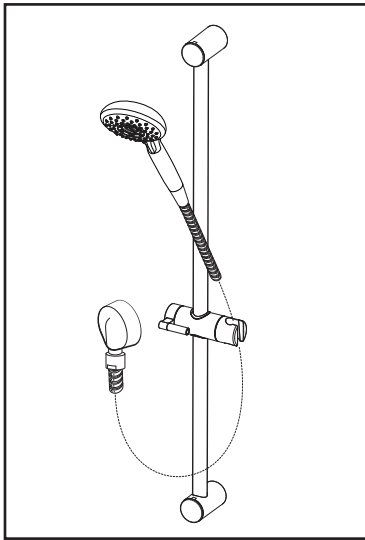

MODEL NUMBER:

☐ **1660.774 Shower System Kit 1.8 version**

Includes:

- Spectra+ Handheld™ 9038.154
- Slide Bar 1660.730
- Hose 8888.035
- Wall Supply 8888.037

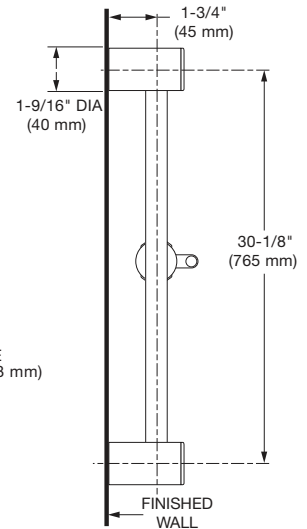
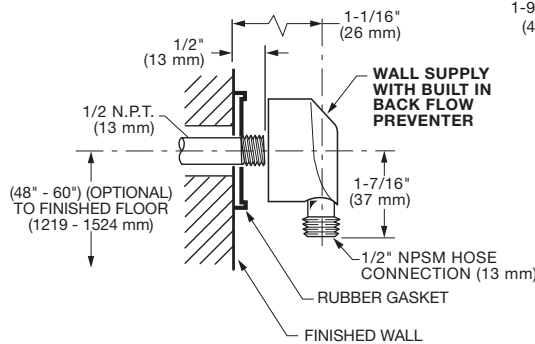
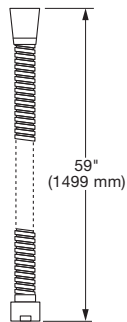
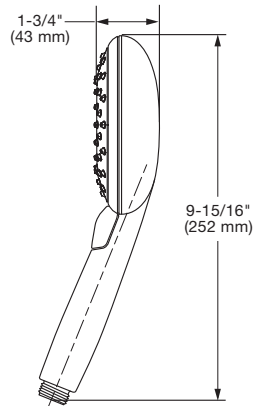

GENERAL DESCRIPTION:

Complete shower system kit includes: a wall supply with 1/2" NPT female inlet, 1/2" NPSM male outlet; a 59" (1500 mm) shower hose; a Spectra+ Handheld water saving hand shower; and a 30" all metal slide bar. 5" (127 mm) Hand shower adjusts from Drench to Sensitive to Powerwash® to Massage. Pressure compensating flow control device. Slide bar features an adjustable shower holder which can be set at any height or position along the bar and angle up to 45°. Kit includes double check valves to prevent cross flow of hot and cold water.

PRODUCT FEATURES:

Water Saving: WaterSense certified.

Pressure Compensating Flow Control Device: Provides consistent flow over a wide pressure range.

Variety of Spray Functions: Allows the user to select the spray functions best suited to their needs.

HAND SHOWER

Lightweight, Ergonomic Design: For a sure grip even with wet, soapy hands.

SLIDE BAR

Simple Height Adjustment: Allows positioning of the personal shower anywhere along the bar.



EPA
WATERSENSE®
CERTIFIED

SUGGESTED SPECIFICATION

Shower system shall feature a wall supply with 1/2" NPT female inlets, 1/2" NPSM male outlet, 59" hose, hand shower and a 30" all metal slide bar. Hand Shower shall be WaterSense certified in water usage. Hand Shower shall have a pressure compensating control device. Kit shall include double check valves to prevent cross flow of hot and cold water. Fitting shall be American Standard Model # 1660.774._____.

CODES AND STANDARDS

These products meet or exceed the following codes and standards:

ASME A112.18.1
CSA B125.1

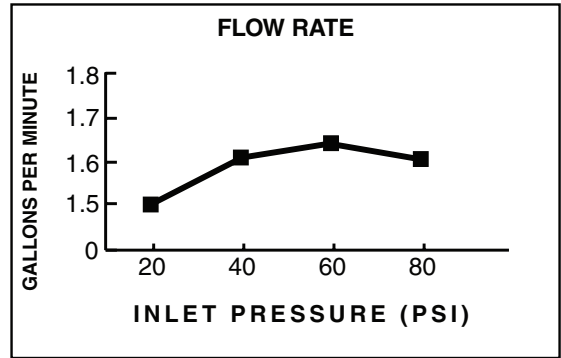

Product Number	Description	Finish			
		Brushed Nickel	Polished Nickel	Legacy Bronze	Polished Chrome
		295	013	278	002
1660.774	Spectra+ Handheld™ Kit. Contains Spectra+™ hand shower, slide bar, hose and wall supply.				

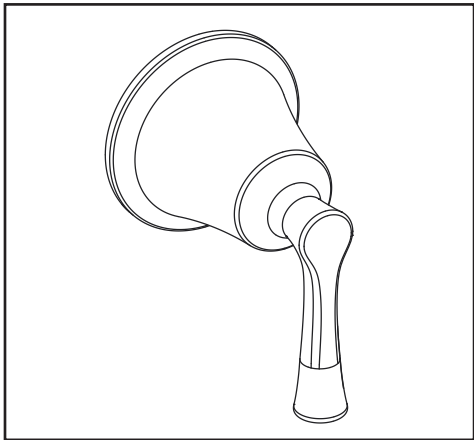

MODEL NUMBER:

TRIM KIT:

- ☐ **T722.430 Diverter Valve Trim**
Valve trim ONLY. LESS Valve.

ROUGH VALVES BODIES:

- ☐ **R422 Two-Way In-Wall Diverter Valve Rough (Discrete)**
1/2" NPT inlets/outlets. 2 Discrete functions. LESS Handle.
- ☐ **R422S Two-Way In-Wall Diverter Valve Rough (Shared)**
1/2" NPT inlets/outlets. 2 Discrete/1 Shared functions. LESS Handle.
- ☐ **R433 Three-Way In-Wall Diverter Valve Rough (Discrete)**
1/2" NPT inlets/outlets. 3 Discrete functions. LESS Handle.
- ☐ **R433S Three-Way In-Wall Diverter Valve Rough (Shared)**
1/2" NPT inlets/outlets. 3 Discrete/3 Shared functions. LESS Handle.

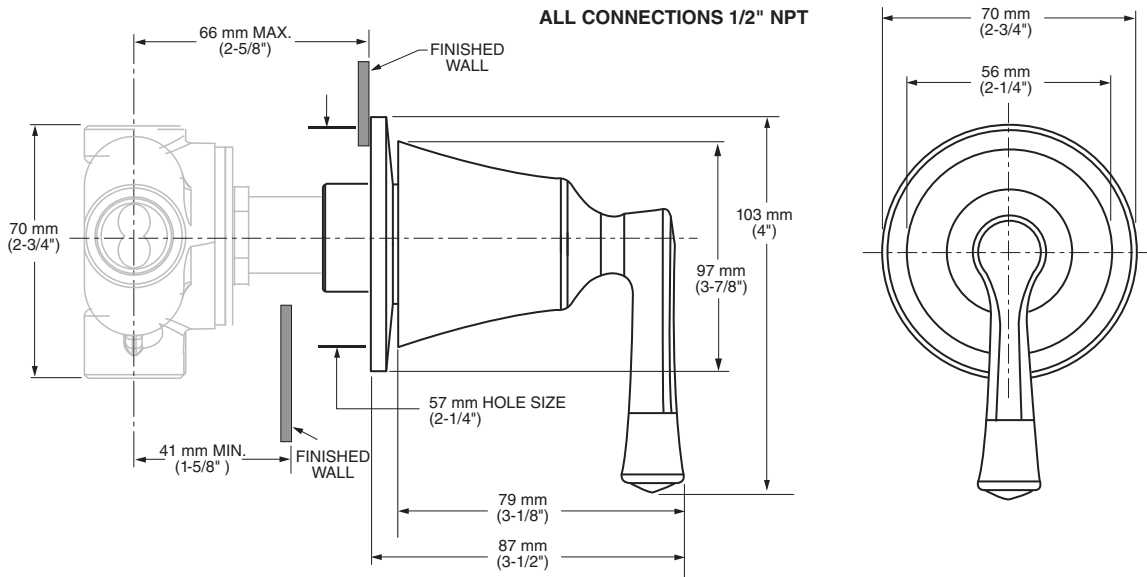

GENERAL DESCRIPTION:

In-Wall Diverter: Rotational control alternates water flow between two (R422/R422S) or three (R433/R433S) different shower outlets (i.e. showerhead, handspray, body side spray or tub spout). Forged brass valve body. Mixed water inlet and two (R422/R422S) or three (R433/R433S) outlets are marked on back of valve body. 1/2" NPT connections on mixed water inlet and two (R422/R422S) or three (R433/R433S) outlets. Stamped brass escutcheon. Tub port with increased water flow (see chart).

PRODUCT FEATURES:

- Solid Brass Construction:** Durable, ideal material for prolonged contact with water.
- Removable Plaster Guard:** Permits checking of valve installation prior to installing trim parts.

NOTE: Cannot be used as a shut-off valve.



ADA COMPLIANT

SUGGESTED SPECIFICATION

Two (three) way diverter shall feature a forged brass body with 1/2" NPT mixed water inlet and outlets. Fitting shall be American Standard Model # T722.430.____ (Diverter Valve Trim) and R4____. (Rough Valve Body).

CODES AND STANDARDS

These products meet or exceed the following codes and standards:

ASME A112.18.1

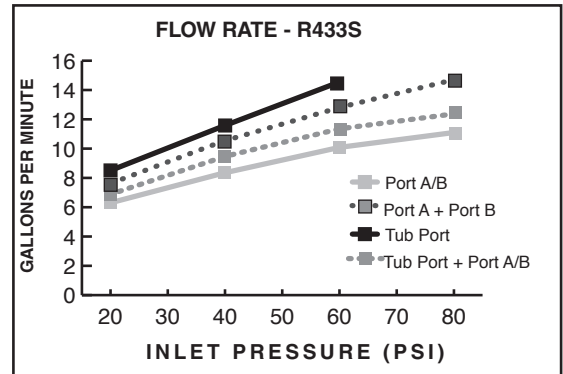
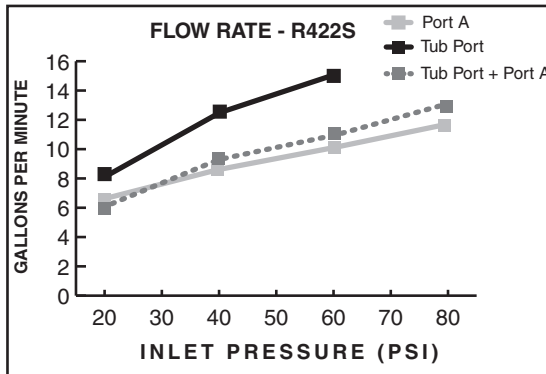
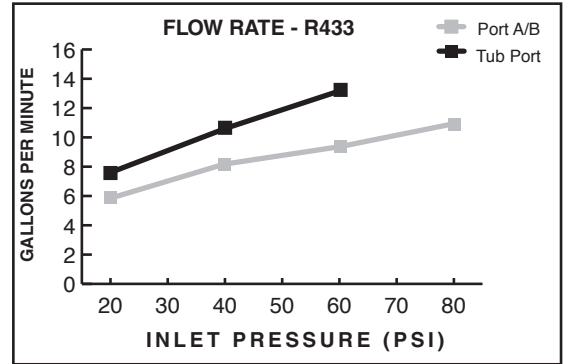
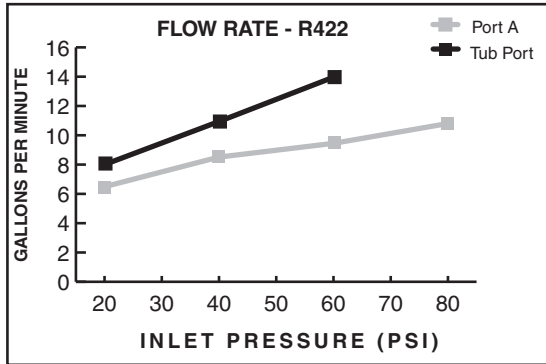

TRIM KITS *	Product Number	Description	* TRIM & ROUGH MUST BE ORDERED SEPARATELY.				Finish Options			
							Polished Nickel	Legacy Bronze	Polished Chrome	PVD Brushed Nickel
							013	278	002	295
	T722.430	Diverter Valve Trim. LESS valve.								

ROUGH VALVE BODIES	Product Number	Description
	R422*	Two-Way In-Wall Diverter. 2 Discrete functions. LESS handle.
	R422S*	Two-Way In-Wall Diverter. 2 Discrete/1 Shared functions. LESS handle.
	R433*	Three-Way In-Wall Diverter. 3 Discrete functions. LESS handle.
	R433S*	Three-Way In-Wall Diverter. 3 Discrete/3 Shared functions. LESS handle.

Meets the American Disabilities Act Guidelines and **ANSI A117.1** Requirements for the physically challenged.

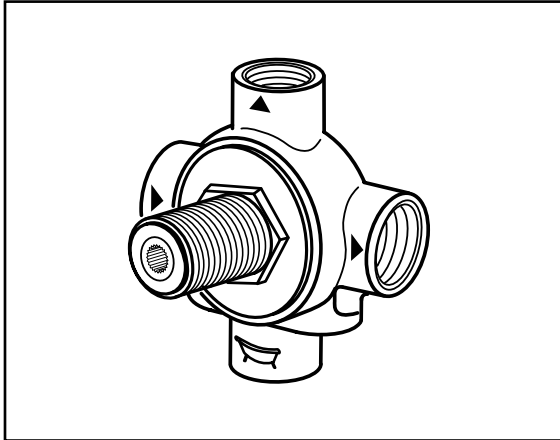

MODEL NUMBER:

- R433 Three-Way In-Wall Diverter Valve Rough (Discrete)**
 1/2" NPT inlets/outlets. 3 Discrete functions. LESS Handle.
- R433S Three-Way In-Wall Diverter Valve Rough (Shared)**
 1/2" NPT inlets/outlets. 3 Discrete/3 Shared functions. LESS Handle.

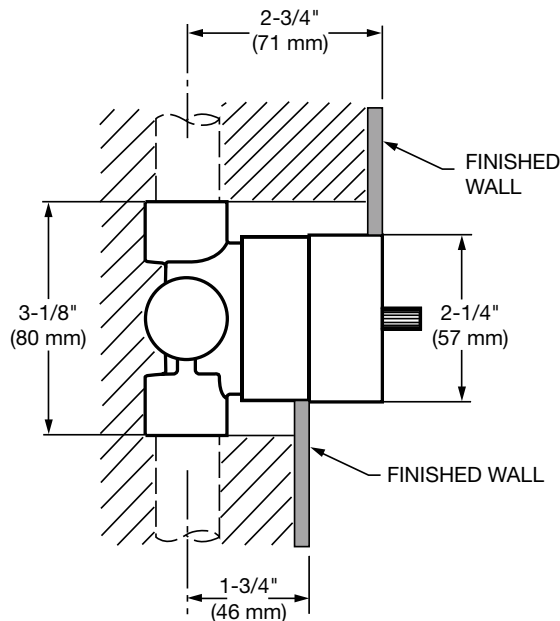

ALL CONNECTIONS 1/2" NPT

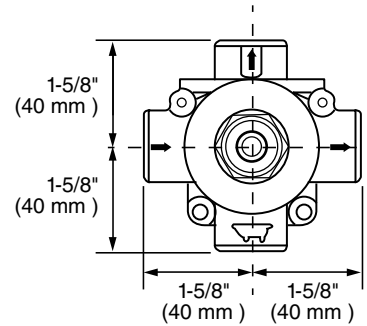

DIVERTER OPERATION	
R433 DISCRETE FUNCTIONS 	R433S SHARED FUNCTIONS

GENERAL DESCRIPTION:

In-Wall Diverter: Rotational control alternates water flow between three different shower outlets (i.e. showerhead, handspray, body side spray or tub spout). Forged brass valve body. Mixed water inlet and three outlets are marked on back of valve body. 1/2" NPT connections on mixed water inlet and three outlets. Stamped brass escutcheon. Tub port with increased water flow (see chart).

NOTE: Cannot be used as a shut-off valve.

PRODUCT FEATURES:

- Solid Brass Construction:** Durable, ideal material for prolonged contact with water.
- Removable Plaster Guard:** Permits checking of valve installation prior to installing trim parts.

SUGGESTED SPECIFICATION

Three way diverter shall feature a forged brass body with 1/2" NPT mixed water inlet and outlets. Fitting shall be American Standard Model # R433_.

CODES AND STANDARDS

These products meet or exceed the following codes and standards:

ASME A112.18.1
CSA B125.1



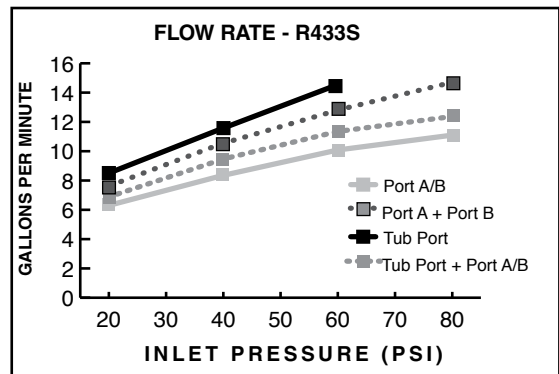
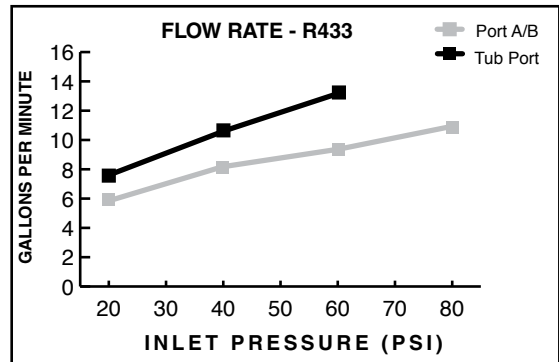











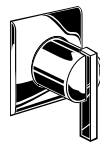
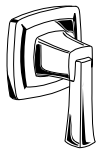



 Meets the American Disabilities Act Guidelines and **ANSI A117.1** Requirements for the physically challenged.







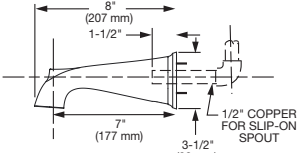

ROUGH VALVE BODIES	Product Number	Description
	R433*	Three-Way In-Wall Diverter. 3 Discrete functions. LESS handle.
	R433S*	Three-Way In-Wall Diverter. 3 Discrete/3 Shared functions. LESS handle.

*Rough and Trim must be ordered separately.

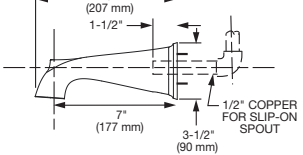
R433 and R433S will accept the following handles:

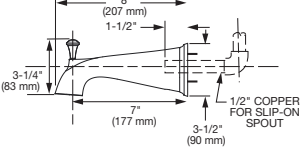
AVAILABLE TRIM KITS	Town Square®	Serin®	Green Tea®	Moments®	Times Square®	Townsend®
						
	T555.430 	T064.430 	T010.430 	T506.430 	T184.430 	T353.430 
	Berwick®	Berwick®	Portsmouth®	Portsmouth®	Quentin®	
						
T430.430 	T430.432	T420.430 	T420.432	T440.430 		

Model #	Description	Finishes	Roughing-In Dimensions
<p>8888107</p> 	<p>Slip-On Non-Diverter Tub Spout</p> <ul style="list-style-type: none"> • For 1/2" copper pipe • Metal Construction • 7-3/4" length to center of outlet 	<p>.002 Polished Chrome .295 Brushed Nickel (PVD) .013 Polished Nickel .278 Legacy Bronze</p>	
<p>8888106</p> 	<p>Non-Diverter 1/2 IPS Tub Spout</p> <ul style="list-style-type: none"> • For 1/2" copper pipe • Metal Construction • 7-3/4" length to center of outlet 	<p>.002 Polished Chrome .295 Brushed Nickel (PVD) .013 Polished Nickel .278 Legacy Bronze</p>	
<p>8888105</p> 	<p>Slip-On Diverter Tub Spout</p> <ul style="list-style-type: none"> • For 1/2" copper pipe • Metal Construction • 7-3/4" length to center of outlet 	<p>.002 Polished Chrome .295 Brushed Nickel (PVD) .013 Polished Nickel .278 Legacy Bronze</p>	
<p>8888104</p> 	<p>Diverter 1/2 IPS Tub Spout</p> <ul style="list-style-type: none"> • For 1/2" copper pipe • Metal Construction • 7-3/4" length to center of stream outlet 	<p>.002 Polished Chrome .295 Brushed Nickel (PVD) .013 Polished Nickel .278 Legacy Bronze</p>	