

PINTBROOK™ URINAL

- Vitreous china
- High Efficiency operates in the range of 0.125 gpf to 0.50 gpf (0.47 Lpf/1.9 Lpf)
- Powerful washdown action
- Optimized chinaware contours provide superior splash protection
- 3/4" inlet top spud
- Outlet connection threaded 2" NPT
- Wall hangers included
- Fixture only
- Made in Mexico (NAFTA compliant)

6002.001 Top spud

Nominal Dimensions:

366 x 364 x 575mm
(14-7/16" x 14-5/16" x 22-5/8")

Recommended working pressure – between 20 psi at valve when flushing and 80 psi static

Compliance Certifications -

Meets or Exceeds the Following Specifications:

- ASME A112.19.2-2008/CSA B45.1-08 for Vitreous China Fixtures



SEE REVERSE FOR ROUGHING-IN DIMENSIONS

To Be Specified:

- Color: White
- Flush Valve:

0.5 gpf Flush Valve: Sensor-Operated:

- American Standard Selectronic® #6063.051.002 DC Power

0.5 gpf Flush Valve: Manual-Operated:

- American Standard #6045.051.002

0.125 gpf Flush Valve: Sensor-Operated:

- American Standard Selectronic® #6063.013.002 DC Power

0.125 gpf Flush Valve: Manual-Operated:

- American Standard #6045.013.002



When used with
0.125 gpf or 0.5 gpf
urinal flush valves

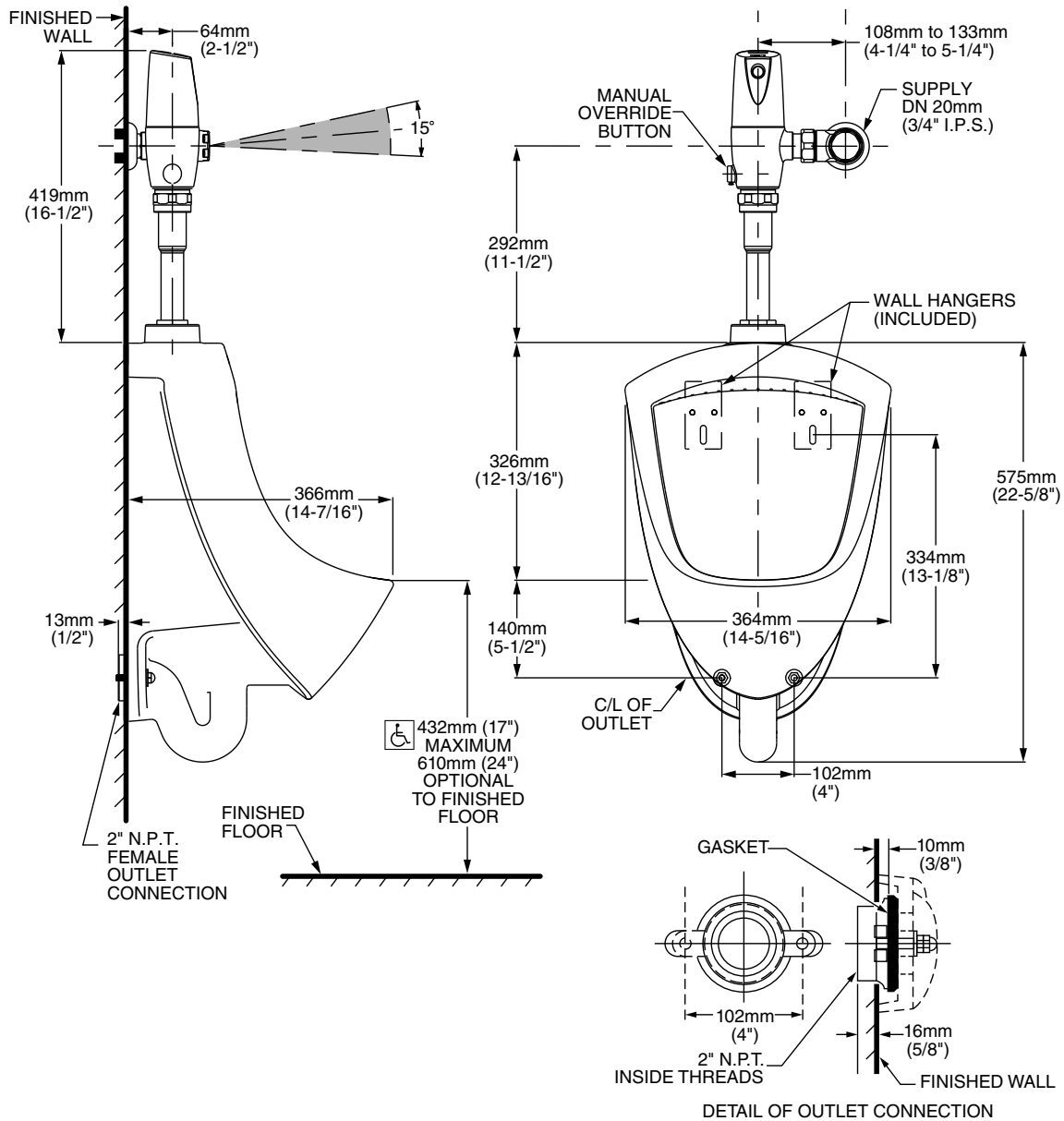

NOTES:
FLUSH VALVE NOT INCLUDED WITH FIXTURE AND MUST BE ORDERED SEPARATELY.
PROVIDE SUITABLE REINFORCEMENT FOR ALL WALL SUPPORTS.

♿ **MEETS THE AMERICANS WITH DISABILITIES ACT GUIDELINES AND ANSI A117.1 ACCESSIBLE AND USEABLE BUILDINGS AND FACILITIES - CHECK LOCAL CODES.**
When installed so top of rim is 432mm (17") maximum from finished floor.

IMPORTANT: Dimensions of fixtures are nominal and may vary within the range of tolerances established by ANSI Standard A112.19.2. These measurements are subject to change or cancellation. No responsibility is assumed for use of superseded or voided pages.

SELECTRONIC® SENSOR-OPERATED URINAL FLUSH VALVE, 0.5 GPF BATTERY POWERED



GENERAL DESCRIPTION:

Exposed, sensor-operated Selectronic® Urinal Flush Valve for 3/4" top spud urinals. CR-P2 lithium battery powered.

PRODUCT FEATURES:

- **Factory-Installed CR-P2 Lithium Battery**
- **Pressure Compensation** feature ensures accurate flush volume regardless of inlet water pressure
- **Self-Cleaning Piston** with integral wiper spring significantly reduces clogging and maintenance
- **No Routine Maintenance** no diaphragms to replace; no filters to clean
- **Selectronic® Proximity System** with universal sensor provides hygienic, "hands free" operation
- **State-of-the-Art Electronics** prevent ghost flushing
- **Dezincification Resistant** brass alloy
- **Fully Mechanical Manual Override Button** can flush the valve without power
- **Fail-Safe:** Valve automatically closes upon loss of power or water pressure and does not need to be reset
- **Adjustable Sanitary Flush** cleans the fixture & maintains the trap seal.
- **Stadium Feature:** Valve automatically switches to water savings mode during periods of heavy usage
- **Chemical Resistant EPDM Seals** for extended life
- **High Back Pressure Vacuum Breaker**
- **Adjustable Tailpiece**
- **Range can be adjusted manually or with optional remote control**
- **No external volume adjustment.**
- **Can be installed left or right handed**

MODEL NUMBER:

- **6063.051.002** Exposed, sensor-operated flush valve for 3/4" top spud urinals, 0.5 gpf.

Inlet includes 3/4" sweat solder kit and angle stop with back flow protection and vandal-resistant cap.

Outlet includes 3/4" high back pressure vacuum breaker with spud coupling and flange.

OPERATING PRESSURE:

20 psi (flowing) - 80 psi (static)

FLOW REQUIREMENT:

10 gpm (37.9 L/min.)

BATTERY LIFE:

4 years @ 4,000 flushes per month

OPTIONAL ACCESSORY:

- Cast wall flange with set screw (6065816.002)
- 12-1/2" long vacuum breaker (M964446-0020A) - 4" longer than standard

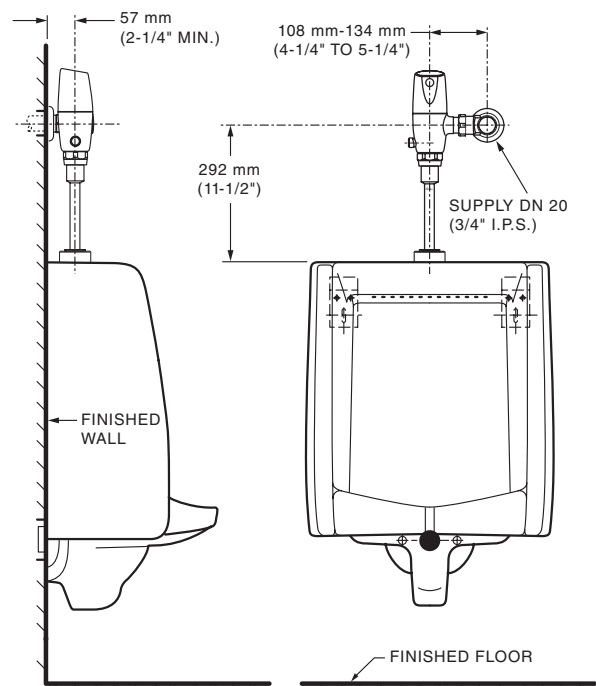

RECOMMENDED SPECIFICATION:

Electronic, sensor activated urinal flush valve shall feature self-cleaning piston valve with integral wiper spring in refill orifice to prevent clogging. Includes a factory-installed CR-P2 lithium battery and fully mechanical manual override that can flush the valve without power. Includes dezincification-resistant brass valve body and metal cover with chrome finish. Includes angle stop with back-flow protection & vandal-resistant cap. Sweat solder kit and high back pressure vacuum breaker also included. 0.5 gpf / 1.9 Lpf flush valve shall be American Standard Model # 6063.051.002.

LISTINGS:

- ASSE 1037
- ANSI/ASME A112.19.2
- ADA Compliant

Roughing-in Dimensions

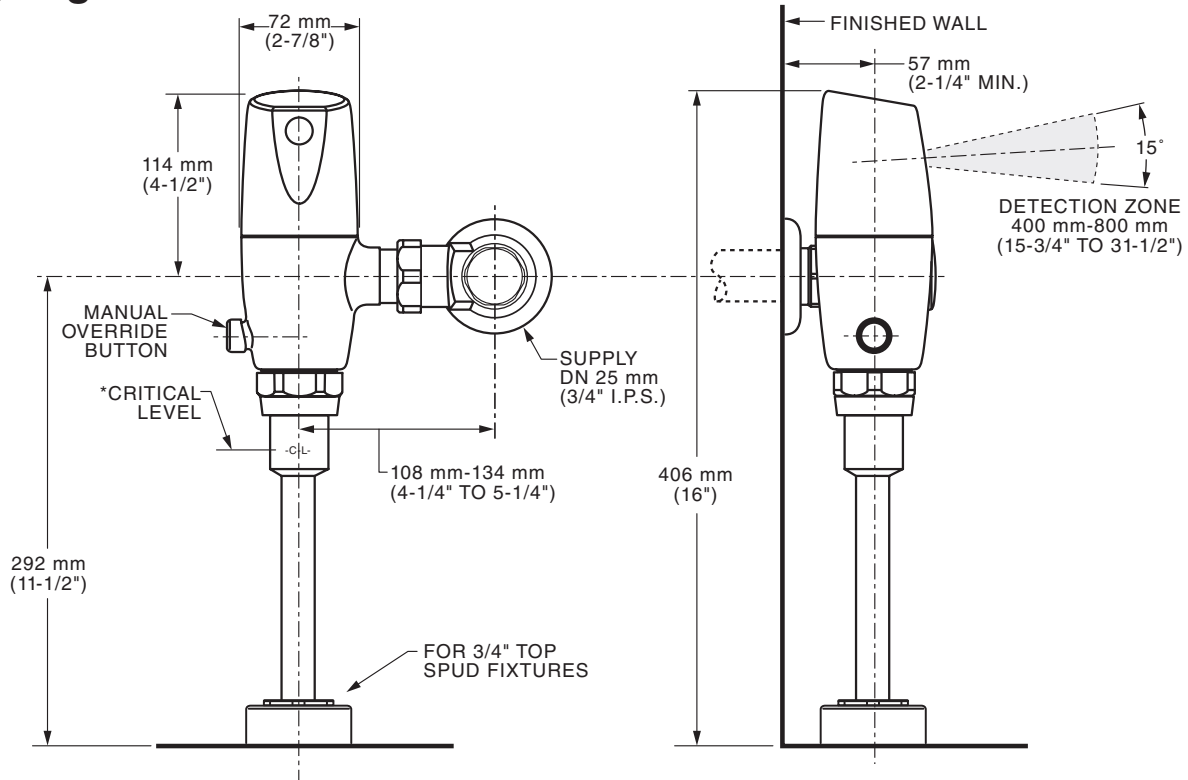

*Note: The Critical Line (-C-L-) on Vacuum Breaker must typically be 6" (152mm) above fixture. Consult Codes for details.

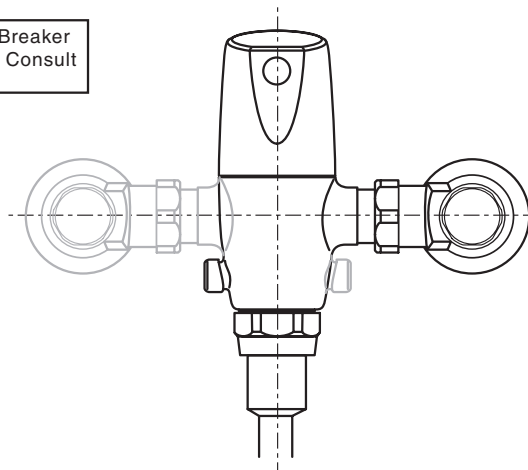

Right or Left Hand Installation