

# URINALS

## MODEL NUMBERS

*American Standard*

**WASHBROOK**  
**6501. SERIES TOP SPUD**  
**6506. SERIES BACK SPUD**

**LYNBROOK**  
**6531.019 TOP SPUD**  
**6538.010 BACK SPUD**  
**6601.012 TOP SPUD**  
**6605.027 BACK SPUD**

**TRIMBROOK**  
**6561.017**

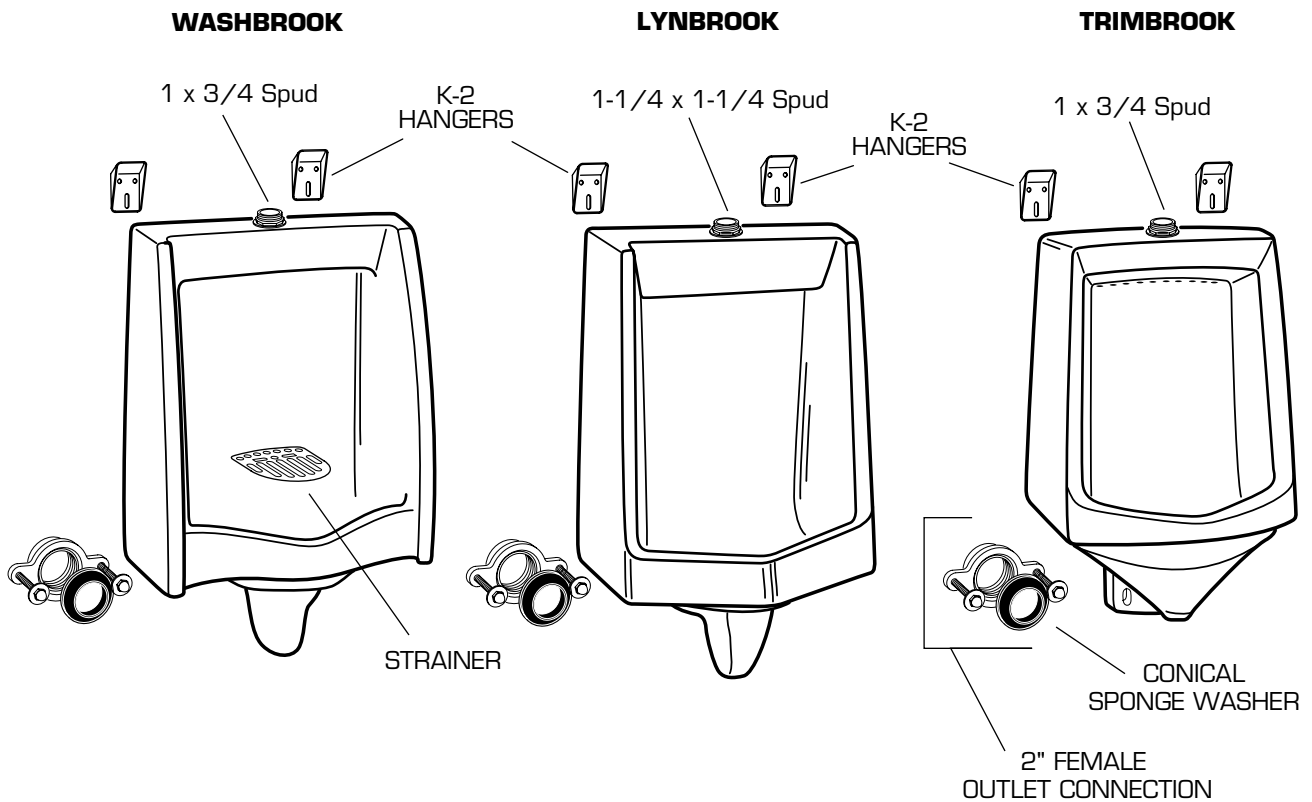

DESCRIPTION	PART NUMBER	PKG QTY
Inlet Spud 1 x 3/4	047003-0070A	1
Inlet Spud 1-1/4 x 1-1/4	047005-0070A	1
K-2 Hanger (2 required)	047058-0070A	1
2" Female Outlet Connection w/Bolts, Washer, and Conical Sponge Washer	047082-0070A	1
Conical Sponge Washer	034638-0070A	1
Strainer (Washbrook only)	047068-0070A	1

*American Standard*

# Ultima™ Manual Urinal Flush Valve, Piston-Type 3/4" Top Spud, 1.0 gpf

MODEL NUMBERS

**6045.101**

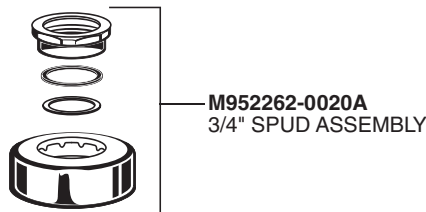
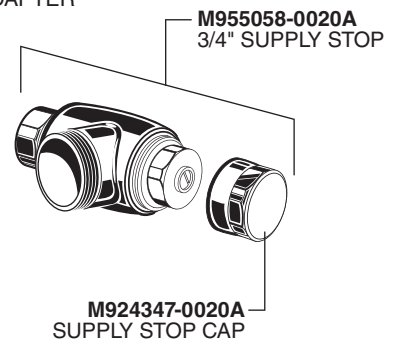
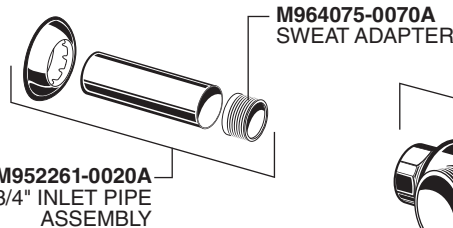
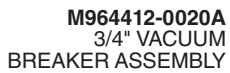
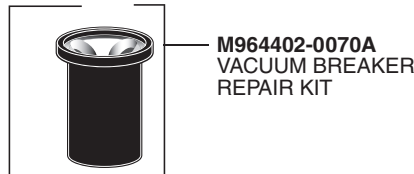
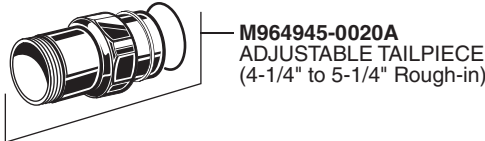
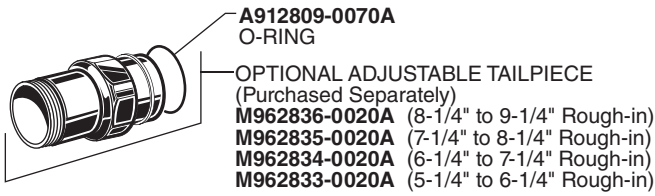
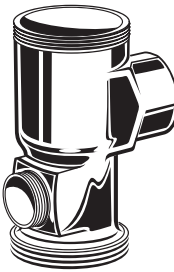
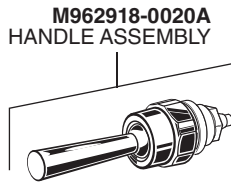
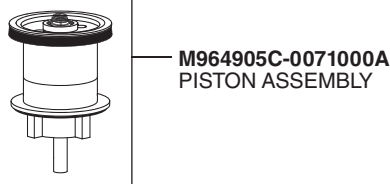
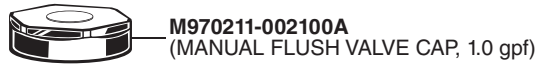

PART OF **LIXIL**



HOT LINE FOR HELP  
For toll-free information and answers to your questions, call:  
(844) CRT-TEAM / (844) 278-8326  
Weekdays 8:00 a.m. to 6:00 p.m. EST  
IN MEXICO 01-800-839-1200  
IN CANADA 1-800-387-0369 (TORONTO 1-905-306-1093)  
Weekdays 8:00 a.m. to 7:00 p.m. EST

Product names listed herein are trademarks of AS America, Inc. ©2019

To learn more about American Standard Selectronic® Products visit our website at:  
[www.americanstandard-us.com](http://www.americanstandard-us.com) or e-mail us at: [CRTTEAM@lixilamericas.com](mailto:CRTTEAM@lixilamericas.com)