

NEONFLEX PRO-L SERIES

24V DC RGBW Side Bend Neon

Neonflex Pro is the next generation solution for achieving seamless lines of direct view lighting for any architectural-grade install. UV, flame, and saltwater resistant, Neonflex Pro is not only durable, but easy to install. Featuring multiple power feed options, in-field customization makes for a versatile option for any interior or exterior application.

- RGBW lateral (side bend) LED neon
- Lumen output performance up to 97Lm per foot
- Consumes up to 4.57W per foot
- Cuttable every 2.46" with 16.4ft max run
- Quick install field connections: Front, Side, and Bottom feeds
- UV, flame, and saltwater resistant
- IP67 rating featuring sealed silicone jacketing
- Dimmable (5-100%) with most DMX controls
- cULus Listed for indoor and outdoor wet locations
- 54,000 hours rated life



PROJECT: _____

TYPE: _____

LOCATION: _____

CATALOG NUMBER: _____



NEONFLEX PRO-L RGBW SERIES QUICK SPECS

VOLTAGE	24V DC
WATTAGE	4.57W / ft
LUMENS	Up to 97Lm / ft
COLOR	RGBW (3000K)
MAX RUN	16.4ft (5m)
CUTTING POINTS	2.46" (62.5mm)
IP RATING	IP67 - Jacketed
DIMMING	(5-100%) Via DMX Controls
DIMENSIONS	0.47" (12mm) W x 0.79" (20mm) H
BEAM ANGLE	120°
STORAGE TEMP	-25°C (-13°F) to 60°C (140°F)**
AMBIENT TEMP	-25°C (-13°F) to 45°C (113°F)**
OPERATING TEMP	-25°C (-13°F) to 45°C (113°F)**
CERTIFICATIONS	cULus Listed - Wet Location
RATED LIFE	54,000 Hours

**Do not install in inclement weather or extreme temperature conditions (i.e. -25°C (-13°F) and below). Recommended to order Custom Cut direct from American Lighting for outdoor installations.

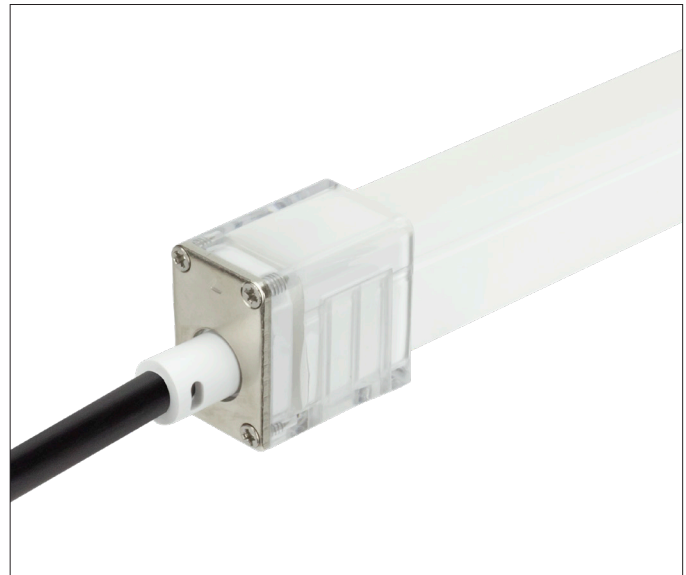

NEONFLEX PRO-L RGBW SERIES QUICK LOOK

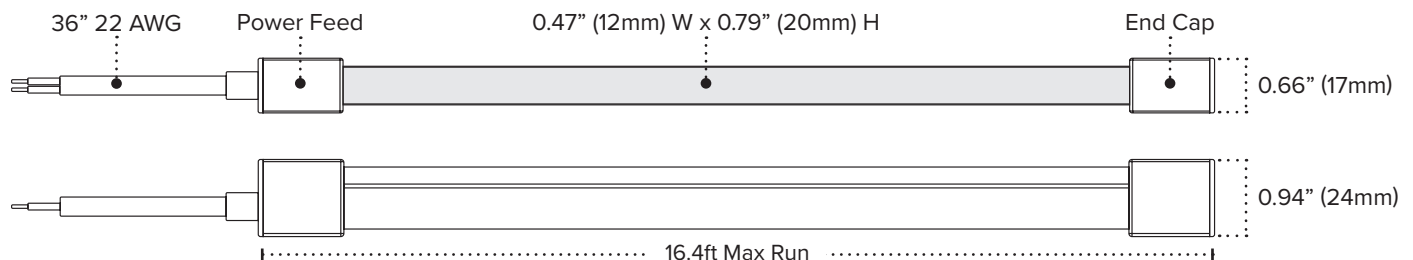

NEONFLEX PRO-L RGBW SERIES ORDERING INFORMATION

ITEM NUMBER	VOLTAGE	COLOR	LENGTH	LUMENS / FT	WATTAGE / FT	IP RATING	CUTTING	MAX RUN
NFPROL-RGBW-98	24V DC	RGBW (3000K)	98 ft	97Lm / ft	4.57W / ft	IP67	2.46" (62.5mm)	16.4 ft
NFPROL-RGBW-CC	24V DC	RGBW (3000K)	Custom Cut	97Lm / ft	4.57W / ft	IP67	2.46" (62.5mm)	16.4 ft

98ft Reels Include: Attached 3ft Lead Wire w/ Standard Front Left Feed Connector (NFPROL-CONKIT-5PIN-FRNTL)
 Custom Cuts: Order (1) Power Feed and (1) **NFPRO-CC-ASSEMBLY** Assembly Fee per length of NFPRO

NEONFLEX PRO-L RGBW SERIES CUSTOM CUT ORDERING *Custom Cut Orders - Please Allow Up To 2-4 Weeks Order Processing & Delivery*

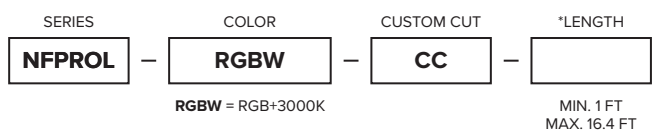

*Custom Cut Lengths must be calculated in 2.46" increments (Min 1ft / Max. 16.4ft). See page 3 for cut increment guide. Each order should include 1x NFPRO-CC-ASSEMBLY and choice of power feed accessory per cut

NEONFLEX PRO-L SERIES ACCESSORIES

ITEM NUMBER	DESCRIPTION
NFPROL-CONKIT-5PIN-FRNTL	36" Pro-L Power Feed - Front Left (5-pin) w/ End Cap
NFPROL-CONKIT-5PIN-FRNTR	36" Pro-L Power Feed - Front Right (5-pin) w/ End Cap
NFPROL-CONKIT-5PIN-BTTL	36" Pro-L Power Feed - Bottom Left (5-pin) w/ End Cap
NFPROL-CONKIT-5PIN-BTTMR	36" Pro-L Power Feed - Bottom Right (5-pin) w/ End Cap
NFPROL-CONKIT-5PIN-SIDL	36" Pro-L Power Feed - Side Left (5-pin) w/ End Cap
NFPROL-CONKIT-5PIN-SIDR	36" Pro-L Power Feed - Side Right (5-pin) w/ End Cap
NFPROL-CONKIT-NS-5PIN-FRNTL	36" Pro-L, Screwless Power Feed - Front Left (5-pin) w/ End Cap
NFPROL-CONKIT-NS-5PIN-FRNTR	36" Pro-L, Screwless Power Feed - Front Right (5-pin) w/ End Cap
NFPROL-5JUMP6	6" Pro-L Linking Cable - Front Feed (5-pin)
NFPROL-5JUMP12	12" Pro-L Linking Cable - Front Feed (5-pin)
NFPROL-5JUMP24	24" Pro-L Linking Cable - Front Feed (5-pin)
NFPROL-5JUMP36	36" Pro-L Linking Cable - Front Feed (5-pin)
NFPROL-CHAN-1M	PRO-L 1m Aluminum Channel 17.3mm W x 21.1mm H
NFPROL-FCHAN-1M	PRO-L 1m Black Aluminum "F" Channel 17.3mm W x 21.1mm H + 20mm Flange

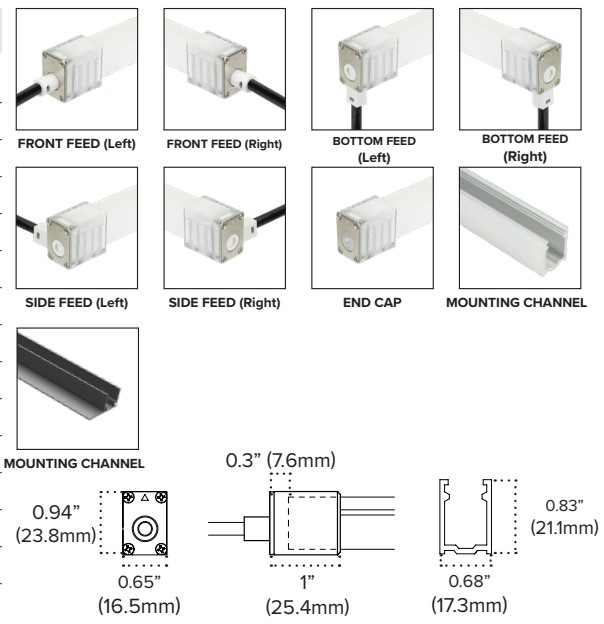

NEONFLEX PRO-L SERIES SPECIAL ORDER ACCESSORIES

ITEM NUMBER	DESCRIPTION
NFPROL-FLEXCHAN-2M	PRO-L 2m Flexible Aluminum Channel 17.3mm W x 21.1mm H

Special Orders - Please Allow Up To 2-4 Weeks Order Processing & Delivery

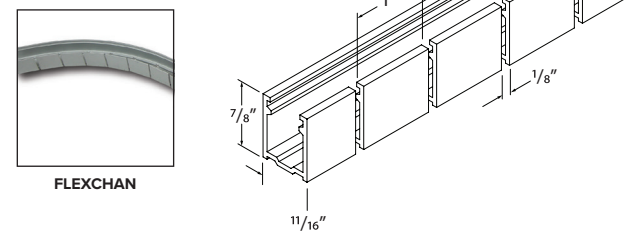

RECOMMENDED POWER SUPPLIES *Phase Dimming Compatible With Most MLV, ELV, and TRIAC Dimmers*

ITEM NUMBER	DESCRIPTION	MAX / MIN LOAD	INPUT VOLTAGE	OUTPUT VOLTAGE	DIMMABLE	DIMENSIONS
ADPT-DRJ-30-24	Adaptive Series 30W	30W / 3W	100-277V AC	24V DC	Yes*	6.49"L x 3.6"W x 1.02"H
ADPT-DRJ-60-24	Adaptive Series 60W	60W / 6W	100-277V AC	24V DC	Yes*	7.4"L x 3.6"W x 1.02"H
ADPT-DRJ-96-24	Adaptive Series 96W	96W / 9.6W	100-277V AC	24V DC	Yes*	8.66"L x 3.6"W x 1.61"H
ADPT-DRJ-192-24	Adaptive Series 192W (2 x 96W)	192W / 19.2W	100-277V AC	24V DC	Yes*	10.94"L x 4.25"W x 1.8"H
ADPT-DRJ-288-24	Adaptive Series 288W (3 x 96W)	288W / 28.8W	100-277V AC	24V DC	Yes*	11.85"L x 4.25"W x 1.8"H

RECOMMENDED HANDLING

2 PERSON INSTALLATION RECOMMENDED
MINIMUM BEND RADIUS ≥24CM

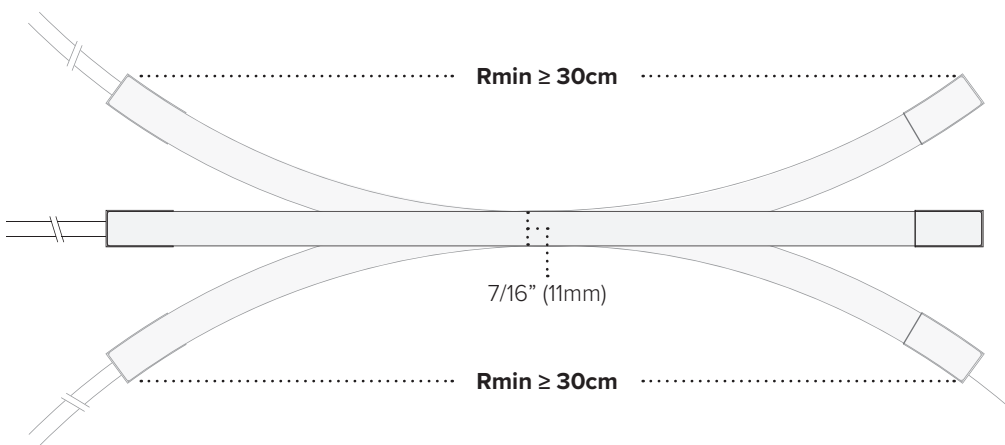
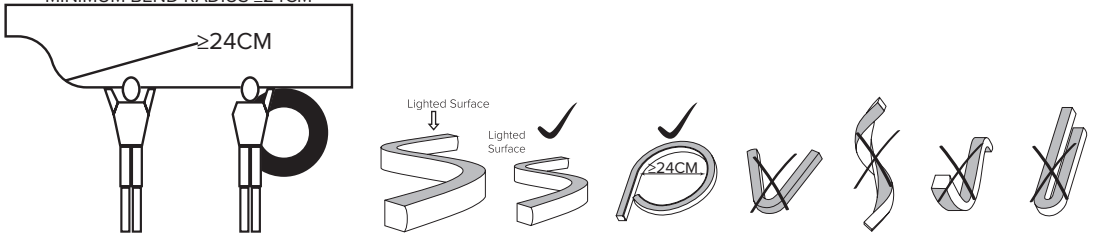

NEONFLEX PRO-L RGBW SERIES CUT INCREMENT GUIDE

Segment	Length (MM)	Length (Inches)	"Length (Feet)"
1	62.5	2.46	0.21
2	125	4.92	0.41
3	187.5	7.38	0.62
4	250	9.84	0.82
5	312.5	12.3	1.03
6	375	14.76	1.23
7	437.5	17.22	1.44
8	500	19.68	1.64
9	562.5	22.14	1.85
10	625	24.6	2.05
11	687.5	27.06	2.26
12	750	29.52	2.46
13	812.5	31.98	2.67
14	875	34.44	2.87
15	937.5	36.9	3.08
16	1000	39.36	3.28
17	1062.5	41.82	3.49
18	1125	44.28	3.69
19	1187.5	46.74	3.90
20	1250	49.2	4.10
21	1312.5	51.66	4.31
22	1375	54.12	4.51
23	1437.5	56.58	4.72
24	1500	59.04	4.92
25	1562.5	61.5	5.13
26	1625	63.96	5.33
27	1687.5	66.42	5.54
28	1750	68.88	5.74
29	1812.5	71.34	5.95
30	1875	73.8	6.15
31	1937.5	76.26	6.36
32	2000	78.72	6.56
33	2062.5	81.18	6.77
34	2125	83.64	6.97
35	2187.5	86.1	7.18
36	2250	88.56	7.38
37	2312.5	91.02	7.59
38	2375	93.48	7.79
39	2437.5	95.94	8.00
40	2500	98.4	8.20

Segment	Length (MM)	Length (Inches)	Length (Feet)
41	2562.5	100.86	8.41
42	2625	103.32	8.61
43	2687.5	105.78	8.82
44	2750	108.24	9.02
45	2812.5	110.7	9.23
46	2875	113.16	9.43
47	2937.5	115.62	9.64
48	3000	118.08	9.84
49	3062.5	120.54	10.05
50	3125	123	10.25
51	3187.5	125.46	10.46
52	3250	127.92	10.66
53	3312.5	130.38	10.87
54	3375	132.84	11.07
55	3437.5	135.3	11.28
56	3500	137.76	11.48
57	3562.5	140.22	11.69
58	3625	142.68	11.89
59	3687.5	145.14	12.10
60	3750	147.6	12.30
61	3812.5	150.06	12.51
62	3875	152.52	12.71
63	3937.5	154.98	12.92
64	4000	157.44	13.12
65	4062.5	159.9	13.33
66	4125	162.36	13.53
67	4187.5	164.82	13.74
68	4250	167.28	13.94
69	4312.5	169.74	14.15
70	4375	172.2	14.35
71	4437.5	174.66	14.56
72	4500	177.12	14.76
73	4562.5	179.58	14.97
74	4625	182.04	15.17
75	4687.5	184.5	15.38
76	4750	186.96	15.58
77	4812.5	189.42	15.79
78	4875	191.88	15.99
79	4937.5	194.34	16.20
80	5000	196.8	16.40



AMERICAN LIGHTING WARRANTY

LIMITED WARRANTY FOR LED PRODUCTS: 3 YEARS

LIMITED PRODUCT WARRANTY

Our products are warranted to be free from defects in material and workmanship for the warranty period listed. Warranty periods begin from the date of shipment from American Lighting Inc's warehouse to the original purchaser. Products that prove to be defective during their specific warranty period will be either repaired or replaced, at the sole discretion of American Lighting Inc. Claims for defective products must be submitted in writing to American Lighting Inc's RGA Department within the warranty period. Upon approval of such return, American Lighting Inc reserves the right to inspect the product for misuse or abuse. Claims for indirect or consequential damages or for product that, in American Lighting Inc's opinion, has been misused will be denied. This is a warranty of product reliability only and not a warranty of merchantability or fitness for a particular purpose. American Lighting Inc shall have no liability whatsoever in any event for payment of incidental or consequential damages, including, without limitations, installation costs and/or damages for personal injury and/or property. These products may represent a possible shock or fire hazard if improperly installed or altered in any way. This warranty does not apply to any product that has not been properly installed in accordance with current local codes and/or the National Electrical Code. Products that require a transformer, driver, or power supply must be used in conjunction with American Lighting Inc's recommended power supply to ensure safety and retain product warranty.

PRODUCT SPECIFICATIONS

For the latest product information, updates, instructions and details concerning specifications, colors, finishes, performance, installation and design, visit www.americanlighting.com. Color may vary from the color printed herein due to limitations in photographic and printing processes. American Lighting Inc. reserves the right to change product specifications without notice. Other product specifications such as color temperature, wavelength characteristics and lumen output are subject to production limitations and may vary. LED technology is changing rapidly, and not all color temperatures and performance levels can be duplicated at a later time. Best practices include purchasing 10-15% more for a particular project on the same initial order where white LED color temperatures must be maintained over project and product life. Eventual product replacement should be considered at layout and design stages. Best practices also include testing connections and product performance prior to mounting and/or installing.

AVERAGE LIFE

Average incandescent lamp life, rated life and average life are terms used to describe the number of hours at which half of the lamps have failed. For LEDs, the hours of rated life specify the point where 70% of original lumen output is reached. Below this point, the effective life is over, however, the LED may still emit light. Individual results may vary with actual environmental conditions including, but not limited to, proper installation, ambient temperature and/or input voltage fluctuations.