

# HYBRID 3 RGBW

## 120V DC 150ft Reels

Superb light output for indoor and outdoor use. Parallel wiring in 12" cutting increments ensures that if one LED goes out, the rest of the LEDs continue to operate. Now available in color changing, Hybrid 3 RGBW adds another element to your hospitality, home theater, and other various entertainment applications.

- 120V DC reels consume only 3 watts per foot
- Cuttable<sup>†</sup> every 12"
- Economical for larger installations - no need for a driver (164ft max run)
- ETL Listed<sup>†</sup> for outdoor, wet locations
- Suitable for indoor and outdoor use
- Requires RGBW control (120-CTRL-4CH DMX Decoder recommended + DMX controller sold separately)
- 30,000 hours rated life



### HYBRID 3 RGBW QUICK SPECS

<b>INPUT VOLTAGE</b>	120V DC
<b>WATTAGE</b>	3W per ft
<b>LUMENS</b>	130Lm/ft
<b>CCT</b>	RGB+3000K
<b>CRI</b>	90+ (3000K)
<b>MAX RUN</b>	164ft (not recommended to exceed 75 feet in any single run)
<b>CUTTING POINTS</b>	12" (305mm) <sup>†</sup>
<b>IP RATING</b>	IP65** - Wet Location
<b>DIMMING</b>	Via DMX / RF Controls
<b>OPERATING TEMP</b>	-30°C (-22°F) to 45°C (113°F) <sup>‡</sup>
<b>AMBIENT TEMP</b>	-20°C (-4°F) to 42°C (107.6°F) <sup>‡</sup>
<b>STORAGE TEMP</b>	-10°C (14°F) to 30°C (86°F)
<b>LED SPACING</b>	Every 0.28"; 15 sets of 4 per foot (120LEDs per meter)
<b>RATING</b>	cETLus Listed (Void if field cut) <sup>†</sup>
<b>RATED LIFE</b>	20,000 Hours

\*\*Do not install in inclement weather or extreme temperature conditions (i.e. -25°C (-13°F) and below). IP65 rated only when used with pre-attached molded power cord and end cap is either pre-attached or properly sealed with dielectric grease, silicone and shrink tube  
<sup>†</sup> cETLus Listing for 120V is void if product is cut. Recommended to order Custom Cut direct from American Lighting for outdoor installations.  
 ‡ It is not recommended to exceed 75 feet in any single run.

### HYBRID 3 RGBW QUICK LOOK

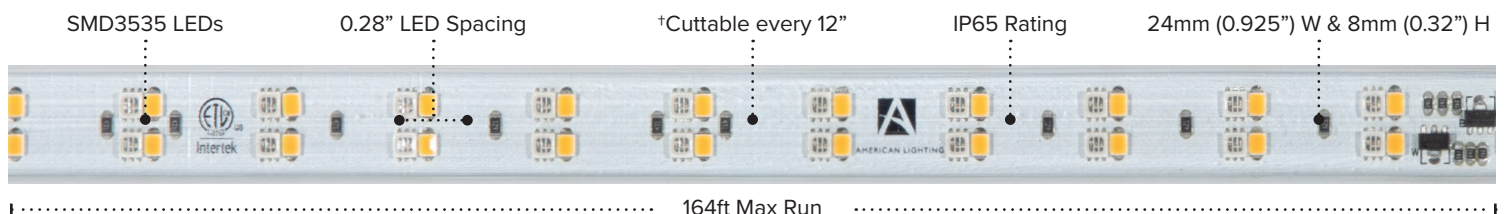

PROJECT: \_\_\_\_\_

TYPE: \_\_\_\_\_

LOCATION: \_\_\_\_\_

CATALOG NUMBER: \_\_\_\_\_



### HYBRID 3 RGBW IP RATINGS

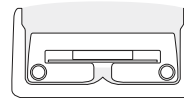

**IP65 (Encased)**  
 Fully encased tape light in sealed jacketing that allows for wet location applications.  
**Best suited:** Indoor & Outdoor wet locations

2 PERSON INSTALLATION RECOMMENDED

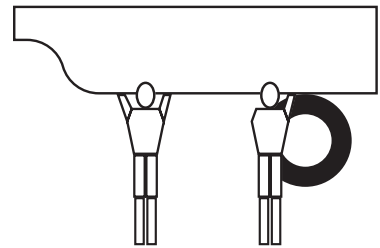

DO NOT TWIST, HANG VERTICALLY, SUSPEND UNSUPPORTED IN THE MIDDLE, OR BEND ALONG SHORT SIDE

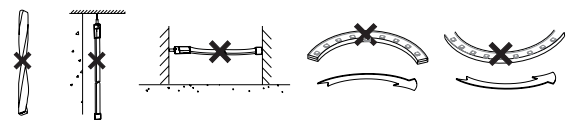

**HYBRID 3 RGBW ORDERING INFORMATION**

PART NUMBER	VOLTAGE	CCT	CRI	WATTAGE	LUMENS	CUTTING	IP RATING	MAX RUN
120-H3-RGBW	120V DC	RGB+3000K	90+ (3000K)	3W / ft	130Lm / ft	12" (305mm)	(IP65) Wet	164'

Hybrid 3 RGBW 150ft Reels Include: (1) 5ft Attached Power Cord to IP65 connection (w/bare wire conkit), (4) 120-H3-RGBW-CONKIT, (50) Clear plastic mounting clips with screws

**HYBRID 3 RGBW ACCESSORIES**

ITEM NUMBER	DESCRIPTION
120-CTRL-4CH	120V AC/DC 4 Channel Controller w/Junction Box
120-H3-RGBW-CONKIT	Block Style End cap with 5ft cable
120-H3-RGBW-JUMP.5	6" linking cable
120-H3-RGBW-JUMP3	3' linking cable
120-H3-RGBW-JUMP6	6' linking cable
120-H3-RGBW-END	End cap
120-H3-RGBW-CLIPS	Mounting clips (QTY 10)
120-H3-RGBW-CHAN-4	4FT Black Aluminum Mounting Channel; Includes Lens
120-H3-RGBW-CHAN-END	Black Plastic End Cap for Aluminum Mounting Channel
120-H3-RGBW-CHAN-FEED	Black Plastic End Cap w/Feed for Aluminum Mounting Channel
REC-DMX-RF	Radio Frequency Receiver (Use w/120-CTRL-4CH + RF Control)
DEC-DMX-JUMP15FT	15' Signal Linking Cable (Use w/120-CTRL-4CH)
RF-RGBW-3AAA	RGBW Handheld 3AAA Remote Control (Use with REC-DMX-RF)

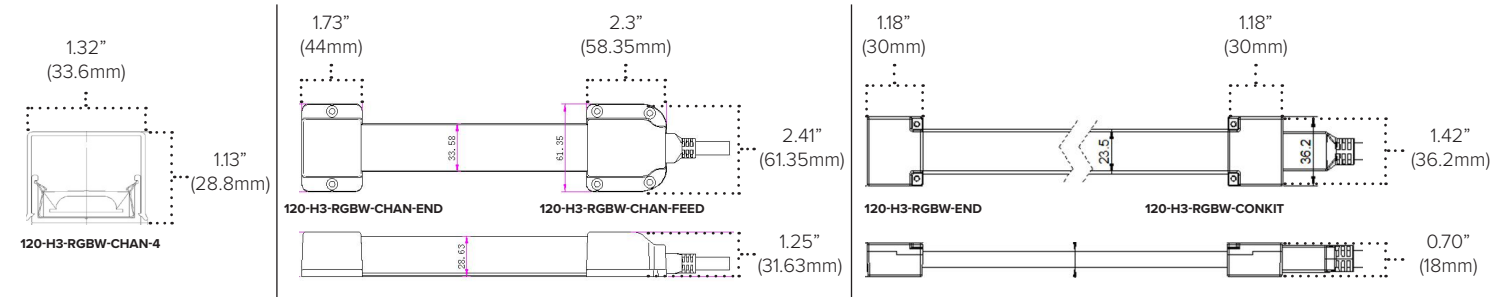

**HYBRID 3 RGBW CONTROL OPTIONS**

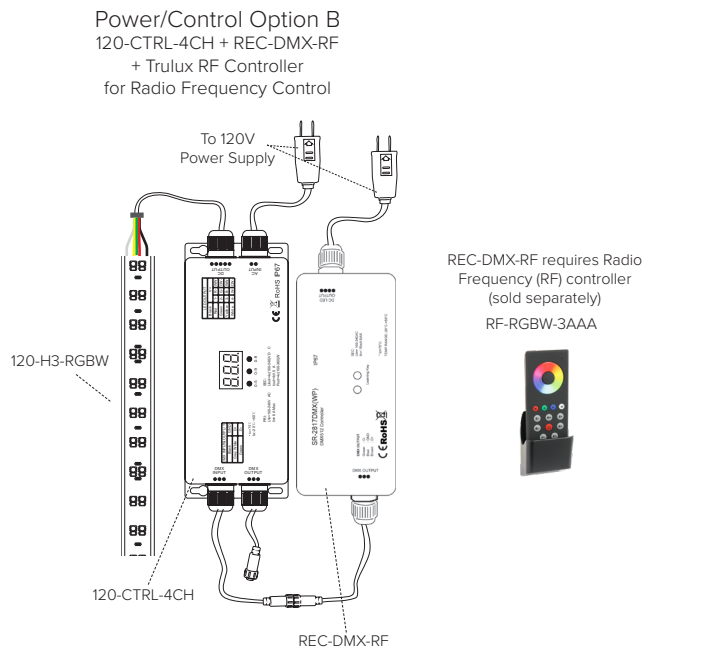
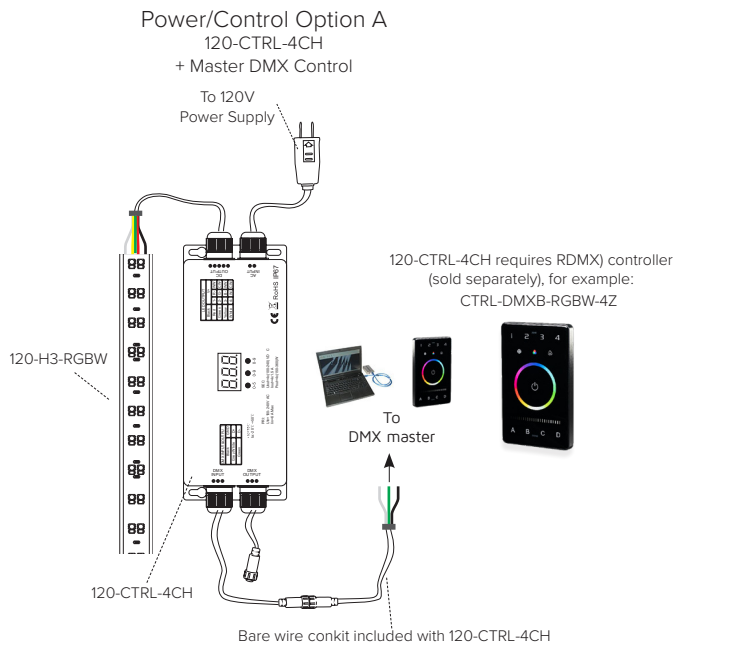



# AMERICAN LIGHTING WARRANTY

## LIMITED WARRANTY FOR LED PRODUCTS: 1 YEAR

### LIMITED PRODUCT WARRANTY

Our products are warranted to be free from defects in material and workmanship for the warranty period listed. Warranty periods begin from the date of shipment from American Lighting Inc's warehouse to the original purchaser. Products that prove to be defective during their specific warranty period will be either repaired or replaced, at the sole discretion of American Lighting Inc. Claims for defective products must be submitted in writing to American Lighting Inc's RGA Department within the warranty period. Upon approval of such return, American Lighting Inc reserves the right to inspect the product for misuse or abuse. Claims for indirect or consequential damages or for product that, in American Lighting Inc's opinion, has been misused will be denied. This is a warranty of product reliability only and not a warranty of merchantability or fitness for a particular purpose. American Lighting Inc shall have no liability whatsoever in any event for payment of incidental or consequential damages, including, without limitations, installation costs and/or damages for personal injury and/or property. These products may represent a possible shock or fire hazard if improperly installed or altered in any way. This warranty does not apply to any product that has not been properly installed in accordance with current local codes and/or the National Electrical Code. Products that require a transformer, driver, or power supply must be used in conjunction with American Lighting Inc's recommended power supply to ensure safety and retain product warranty.

### PRODUCT SPECIFICATIONS

For the latest product information, updates, instructions and details concerning specifications, colors, finishes, performance, installation and design, visit [www.americanlighting.com](http://www.americanlighting.com). Color may vary from the color printed herein due to limitations in photographic and printing processes. American Lighting Inc. reserves the right to change product specifications without notice. Other product specifications such as color temperature, wavelength characteristics and lumen output are subject to production limitations and may vary. LED technology is changing rapidly, and not all color temperatures and performance levels can be duplicated at a later time. Best practices include purchasing 10-15% more for a particular project on the same initial order where white LED color temperatures must be maintained over project and product life. Eventual product replacement should be considered at layout and design stages. Best practices also include testing connections and product performance prior to mounting and/or installing.

### AVERAGE LIFE

Average incandescent lamp life, rated life and average life are terms used to describe the number of hours at which half of the lamps have failed. For LEDs, the hours of rated life specify the point where 70% of original lumen output is reached. Below this point, the effective life is over, however, the LED may still emit light. Individual results may vary with actual environmental conditions including, but not limited to, proper installation, ambient temperature and/or input voltage fluctuations.