

SPEC SERIES DOWNLIGHT

6" & 8" Performance Downlights

Make commercial retrofit projects easier with the Spec Series performance downlights. Select from five color temperatures with just the flip of a switch ranging from 2700K up to 5000K. Spec series downlights are not only 0-10V dimmable, but also feature three light output settings. Allowing for Low, Medium, and High performance levels to be set on the fly making the Spec series downlights a favorite among installers.

- Excellent color rendering (90+ CRI)
- Five selectable color temperature settings: 2700K / 3000K / 3500K / 4000K / 5000K
- Three selectable wattage settings: (Low / Medium / High)
6" = 12W / 18W / 25W / 8" = 20W / 28W / 38W
- Lumen output up to 3100 Lumens (8")
- Dimmable with most 0-10V dimmers
- Remote driver with hardwire junction box
- Type IC and cETLus Listed for wet locations
- ENERGY STAR certified, JA8 Compliant
- 50,000 hours rated life

PROJECT:
TYPE:
LOCATION:
CATALOG NUMBER:



SPEC 6



SPEC 8



SPEC SERIES QUICK SPECS

VOLTAGE	120-277V AC, 60Hz
WATTAGE	Selectable - 12W / 18W / 25W (6") - 20W / 28W / 38W (8")
LUMENS	Up to 2300Lm @4000K (6") / Up to 3100Lm @4000K (8")
CCT OPTIONS	5CCT - 2700K / 3000K / 3500K / 4000K / 5000K
CRI	90+
DIMMING	0-10V (10 - 100%)
MOUNTING	Recessed Mount
BEAM ANGLE	70°
OPERATING TEMP	-20°C (-4°F) to 40°C (104F)
CERTIFICATIONS	cETLus Listed; Type IC; Suitable for wet locations
RATED LIFE	50,000 Hours

SPEC SERIES ORDERING INFORMATION

ITEM NUMBER	DESCRIPTION	FINISH	VOLTAGE	CCT	CRI	LUMENS	WATTAGE	DIMMING
SPEC6-5CCT-AZ	Spec 6	Alzak	120-277V	5-CCT	90+	Up to 2300Lm	Up to 25W	0-10V
SPEC8-5CCT-AZ	Spec 8	Alzak	120-277V	5-CCT	90+	Up to 3100Lm	Up to 38W	0-10V

SPEC SERIES ACCESSORIES

ITEM NUMBER	DESCRIPTION
RP-2/4/6	6" New Construction Rough-in Plate w/Hanger Bars
RP-EM8	8" New Construction Rough-in Plate w/Hanger Bars



6" Rough-in Plate

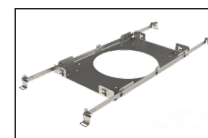

8" Rough-in Plate

SPEC SERIES QUICK DIMENSIONS

SPEC 6

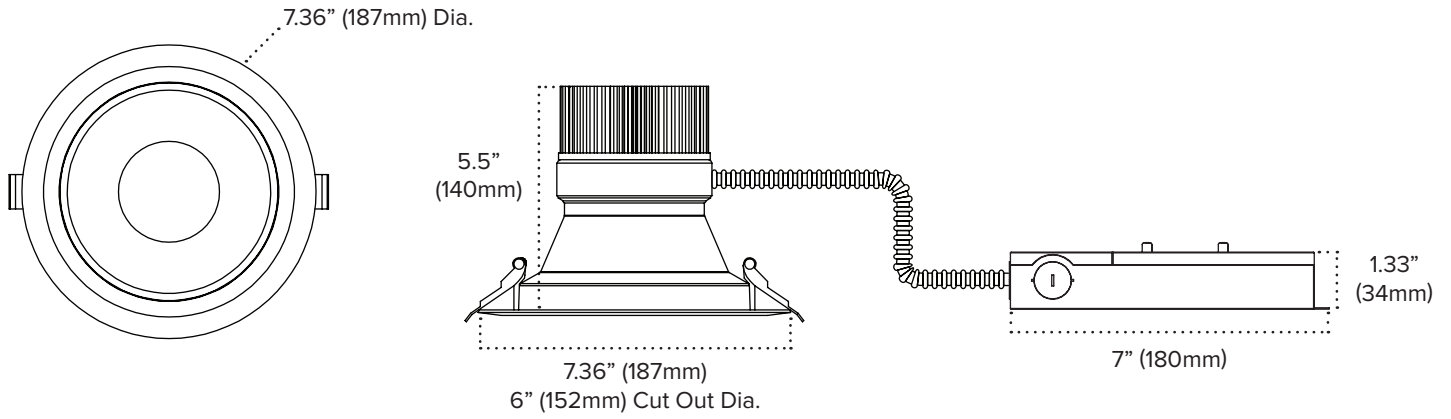

SPEC 8

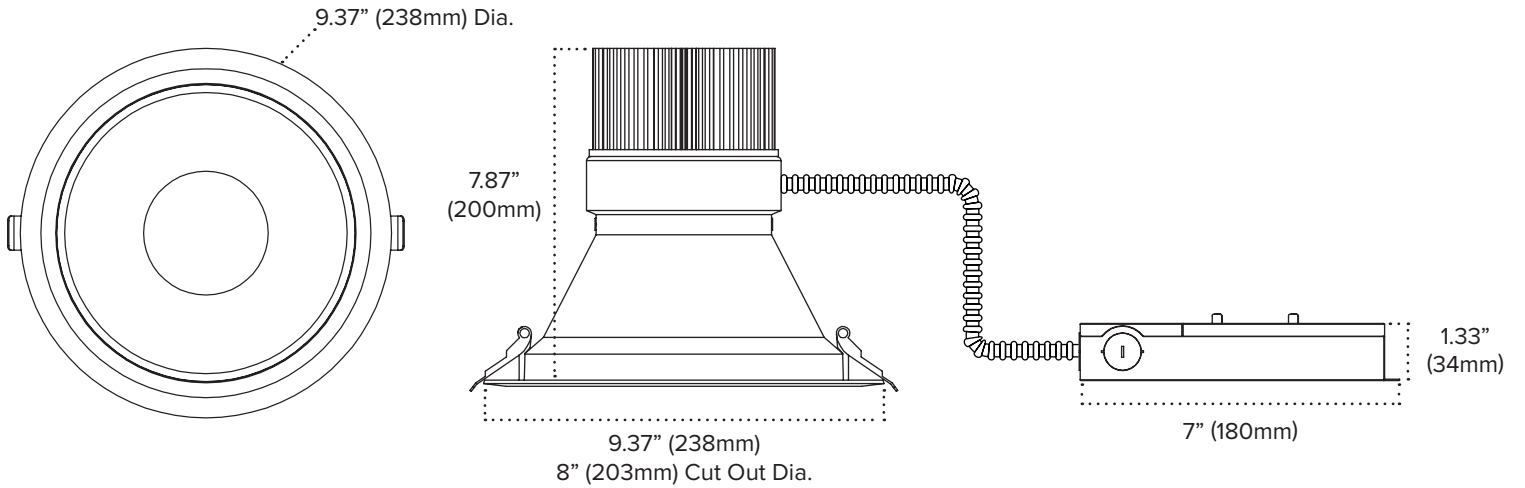

SPEC SERIES PHOTOMETRICS

SPEC6

PART NUMBER	SPEC6-5CCT-AZ
BEAM SPREAD	70°
LUMENS	2300Lm
WATTAGE	25W
EFFICACY	92Lm per watt
CCT	@2700K
CRI	90

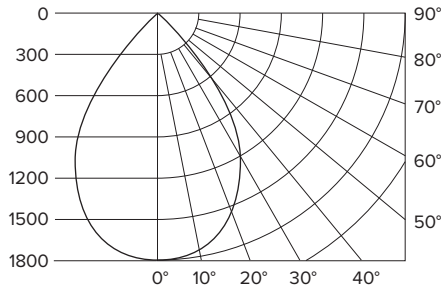

Foot Candles	Distance From Light	Beam Dia.
75	4'	6.9'
42.2	6'	9.2'
27	8'	11.5'
18.8	10'	13.9'
13.8	12'	16.2'
10.5	14'	18.5'

SPEC8

PART NUMBER	NV7-30-WH
BEAM SPREAD	70°
LUMENS	3100Lm
WATTAGE	38W
EFFICACY	81Lm per watt
CCT	@2700K
CRI	90

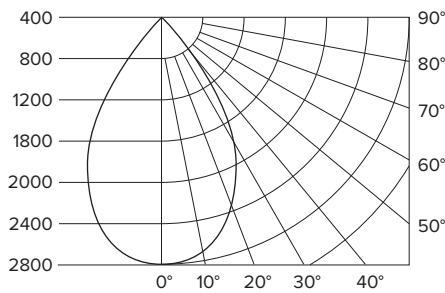

Foot Candles	Distance From Light	Beam Dia.
109.4	4'	4.6'
48.6	6'	6.9'
27.3	8'	9.2'
17.5	10'	11.5'
12.2	12'	13.9'
8.9	14'	16.2'

ADVANTAGE DIRECT SELECT SERIES 6" RECOMMENDED DIMMERS

BRAND	MODEL #	AC INPUT VOLTAGE	0-10V VOLTAGE	RATED POWER	MAX CURRENT OUT (MA)	MIN CURRENT IN (MA)	DIMMING RANGE (%)
Lutron	RMJS-8T-DV-B	120V	0.72-10.04V	5W	0.676	0.105	12-100%
				18W	0.485	0.068	12-100%
				12W	0.303	0.035	12-100%
		277V		25W	0.677	0.098	12-100%
				18W	0.492	0.068	12-100%
				12W	0.312	0.041	12-100%
Legrand	RH4FBL3PW	120V	0.56-5.9V	25W	0.497	0.089	8-70%
				18W	0.355	0.057	8-70%
				12W	0.218	0.028	8-70%
		277V		25W	0.493	0.091	8-70%
				18W	0.354	0.062	8-70%
				12W	0.223	0.036	8-70%
Lutron	DVSTV-LA	120V	0.63-10.1V	25W	0.679	0.098	8-100%
				18W	0.485	0.064	8-100%
				12W	0.303	0.033	8-100%
		277V		25W	0.679	0.098	8-100%
				18W	0.492	0.068	8-100%
				12W	0.311	0.039	8-100%

SPEC6-5CCT-AZ is not compatible with Leviton IP710-LFZ dimmer. Dimmer performance may vary in field application due to unknown external factors. Dimmers not included on the chart above are not necessarily incompatible; they have yet to be fully evaluated. Please reference dimmer manufacturer's instructions for more detailed information regarding performance and compatibility. Test data listed above is based on single lamp data. Recommended maximum 10 units connected to a single dimmer.

ADVANTAGE DIRECT SELECT SERIES 8" RECOMMENDED DIMMERS

BRAND	MODEL #	AC INPUT VOLTAGE	0-10V VOLTAGE	RATED POWER	MAX CURRENT OUT (MA)	MIN CURRENT IN (MA)	DIMMING RANGE (%)
Lutron	RMJS-8T-DV-B	120V	0.72-10.04V	38W	1.018	0.142	12-100%
				28W	0.735	0.096	12-100%
				20W	0.533	0.061	12-100%
		277V		38W	0.998	0.135	12-100%
				28W	0.734	0.098	12-100%
				20W	0.539	0.075	12-100%
Legrand	RH4FBL3PW	120V	0.56-5.9V	38W	0.721	0.121	8-70%
				28W	0.52	0.08	8-70%
				20W	0.375	0.053	8-70%
		277V		38W	0.701	0.117	8-70%
				28W	0.513	0.086	8-70%
				20W	0.377	0.062	8-70%
Lutron	DVSTV-LA	120V	0.63-10.1V	38W	1.017	0.128	8-100%
				28W	0.737	0.086	8-100%
				20W	0.534	0.058	8-100%
		277V		38W	1.01	0.122	8-100%
				28W	0.736	0.091	8-100%
				20W	0.541	0.068	8-100%

SPEC6-5CCT-AZ is not compatible with Leviton IP710-LFZ dimmer.
 Dimmer performance may vary in field application due to unknown external factors. Dimmers not included on the chart above are not necessarily incompatible; they have yet to be fully evaluated. Please reference dimmer manufacturer's instructions for more detailed information regarding performance and compatibility. Test data listed above is based on single lamp data. Recommended maximum 10 units connected to a single dimmer.