

- Please check your product packaging to make sure the included accessories are in the "list of standard accessories". If any parts are missing, please contact your local dealer immediately.

- Do not allow any sharp objects to come in contact with the cabinet, as it will scratch the surface.

- Continuous and prolonged exposure to direct sunlight may cause discoloration to the wood.

- Do not put any hot appliances directly on or near the cabinet.

- Please avoid using cleaning products that contain bleach or ammonia.

- Wood surfaces should only be cleaned with wood care products such as soapy water or furniture polish.

- Vérifiez l'emballage de votre produit SVP pour assurer que les accessoires fournis sont dans la liste des accessoires standards".

- S'il manque des pièces, veuillez contacter immédiatement votre distributeur sur place.

- Les objets pointus sont interdits de toucher le meuble, car ils gratteront la surface.

- L'exposition continue directement sous le soleil peut provoquer une décoloration du bois.

- Ne placez aucune chose chaude directement sur la table ou à côté du meuble.

- N'utilisez pas des produits de nettoyage qui content de l'eau de javel ni de l'ammoniac.

- Les surfaces ne doivent être nettoyées qu'avec produits d'entretien du bois ou de l'eau savonneuse ou vernis pour meubles.

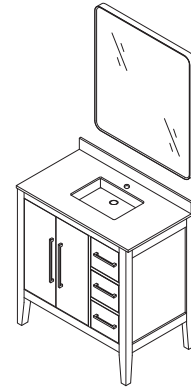

Main Body Parts/La partie principale du corps

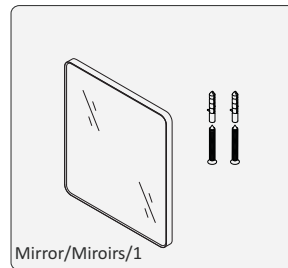
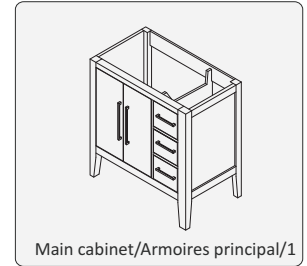
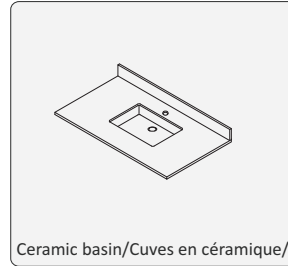

Installation Parts/Partie d'installation

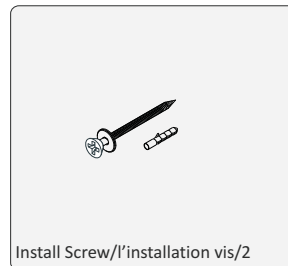

Installation/l'installation

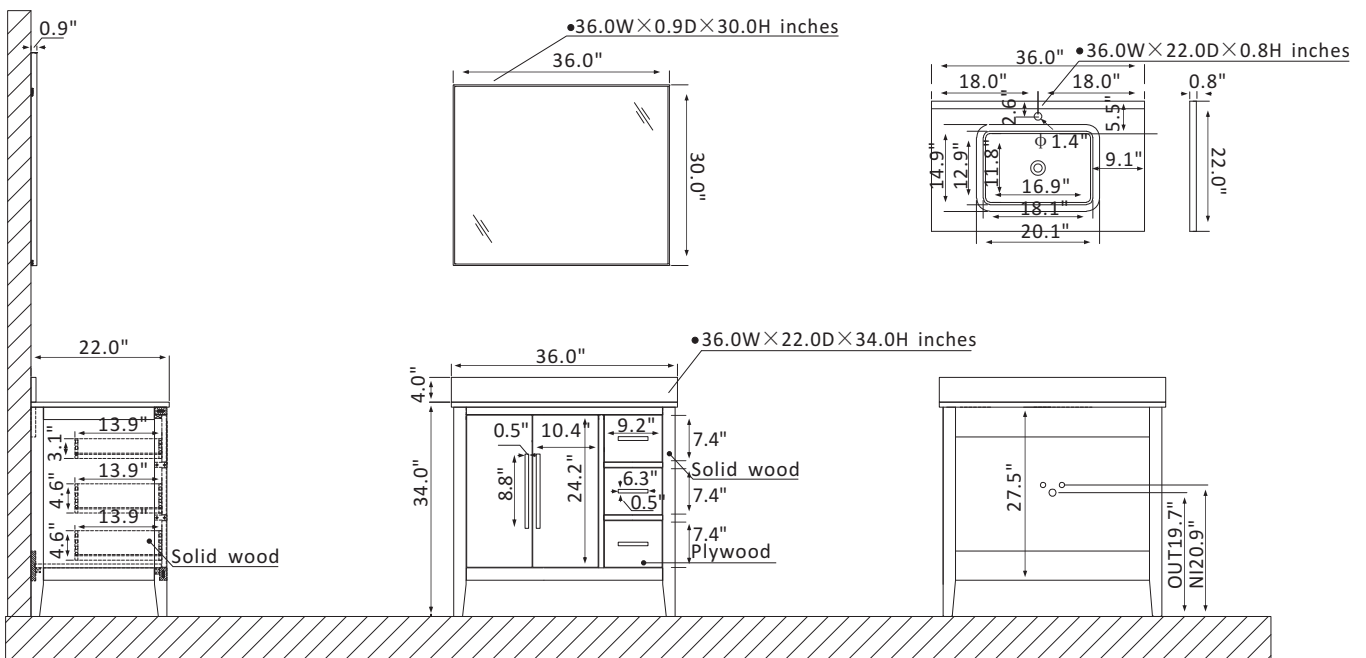

Erecting Tool/Outils d'assemblage

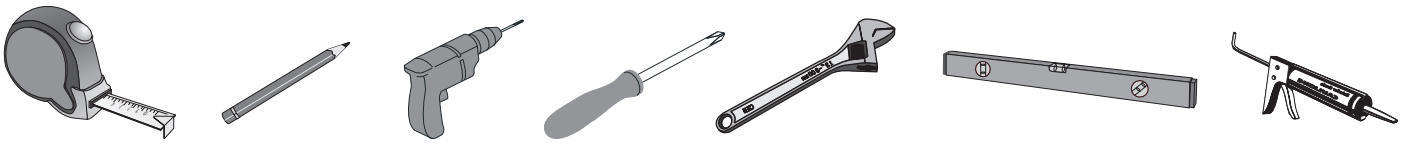

Install, Remove, Adjust Of Top Fast Loading Hinge / Montage, démontage et réglage de la charnière de chargement rapide



Install/l'installation

Remove/mobiles

Adjust the height/Hauteur de réglage

adjust the lateral/Réglage latéral

Adjust the depth/Profondeur de réglage

Installation Instruction/Instructions d'installation

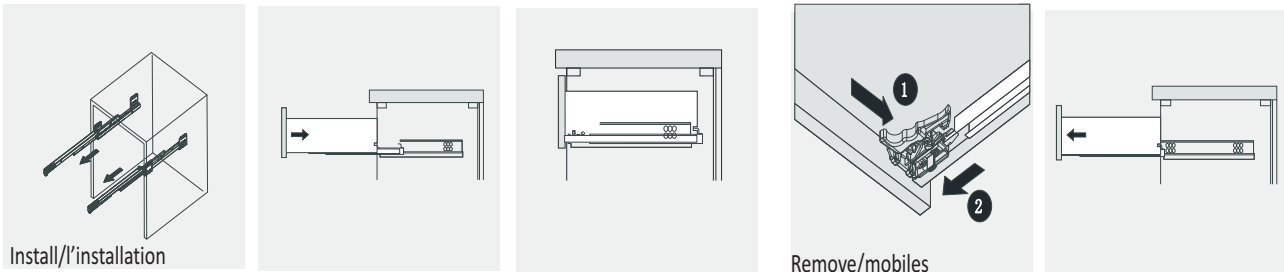

Install/l'installation

Remove/mobiles

Drawer Adjust/ tiroir ajuster

① Apply a bead of adhesive or silicone onto each edge of cabinet top.

② Place ALTAIR vanity top onto the cabinet, making sure vanity is seated properly.

24H
Don't use the vanity for at least 24 hour, in order to allow the glue to cure fully.

1. Sticky Ceramic Basin/Bassin en céramique collant

2. Install pop-up, faucet and basin / Installer des éventails, des robinets et des lavabos

3. Hang the Mirror/Suspendus Miroirs