

INSTALLATION SPECIFICATION

Item No.	SD80260-BP-MB
Description	By-pass
Overall Dimensions	60"X76"
Installation Size Range	56"-60"
Profile Color	Matte Black
Glass Thickness	8/25"
Glass Color	Transparent&Explosion-Proof
Gross Weight	153LBS
Certifications	ANSI Z97.1-2015

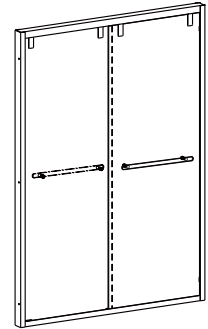

Caspar
By-pass

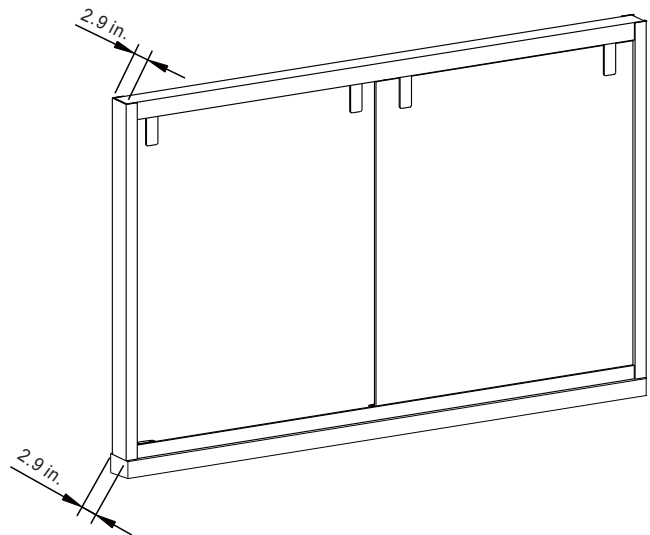
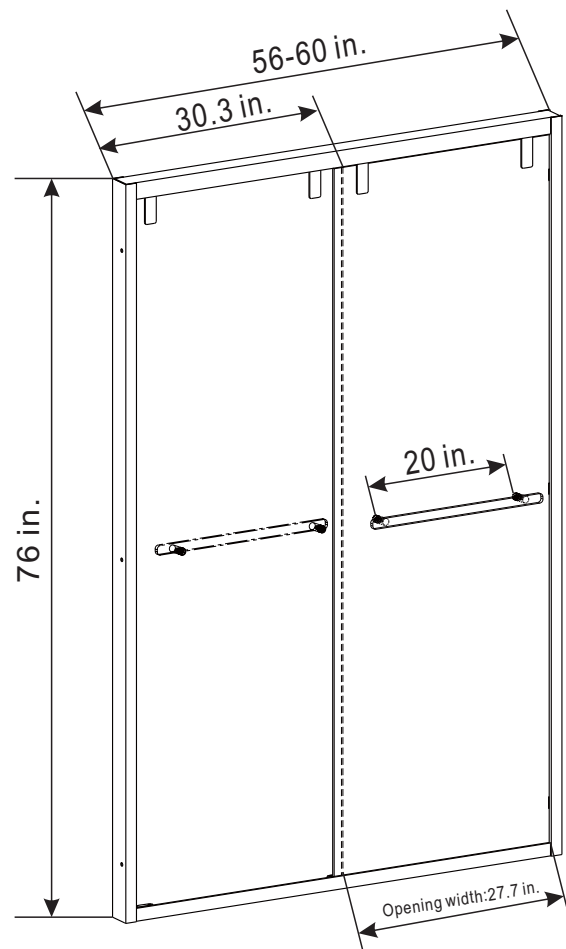

All measurements are approximate. Measurements may vary +/- 1/25".