

Model/Le modèle: 548030

● Please check your product packaging to make sure the included accessories are in the "list of standard accessories". If any parts are missing, please contact your local dealer immediately.

● Do not allow any sharp objects to come in contact with the cabinet, as it will scratch the surface.

● Continuous and prolonged exposure to direct sunlight may cause discoloration to the wood.

● Do not put any hot appliances directly on or near the cabinet.

● Please avoid using cleaning products that contain bleach or ammonia.

● Wood surfaces should only be cleaned with wood care products such as soapy water or furniture polish.

● Vérifiez l'emballage de votre produit SVP pour assurer que les accessoires fournis sont dans la liste des accessoires standards".

● S'il manque des pièces, veuillez contacter immédiatement votre distributeur sur place.

● Les objets pointus sont interdits de toucher le meuble, car ils gratteront le surface.

● L'exposition continue directement sous le soleil peut provoquer une décoloration du bois.

● Ne placez aucune chose chaude directement sur la table ou à côté du meuble.

● N'utilisez pas des produits de nettoyage qui content de l'eau de javel ni de l'ammoniac.

● Les surfaces ne doivent être nettoyées qu'avec produits d'entretien du bois ou de l'eau savonneuse ou vernis pour meubles.

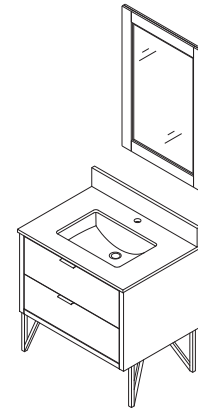

Main Body Parts/La partie principale du corps

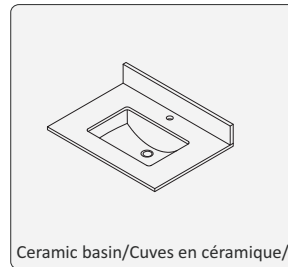

Ceramic basin/Cuves en céramique/1

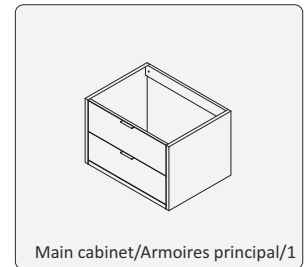

Main cabinet/Armoires principal/1

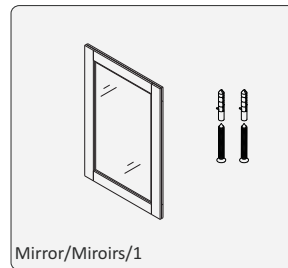

Mirror/Miroirs/1

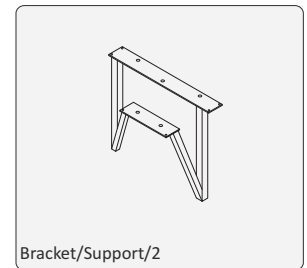

Bracket/Support/2

Installation Parts/Partie d'installation

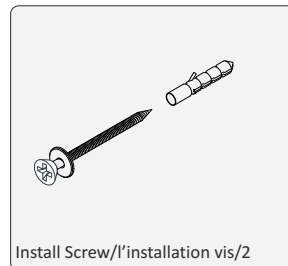

Install Screw/l'installation vis/2

Installation/l'installation

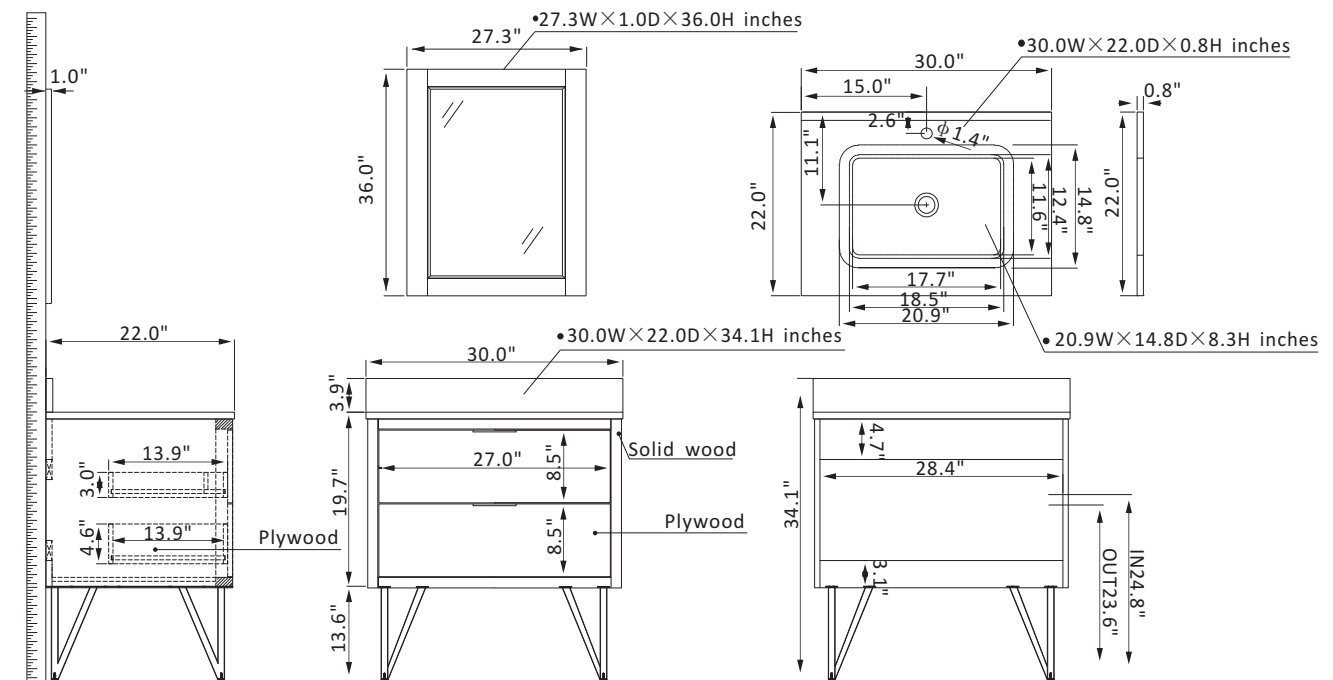

Erecting Tool/Outils d'assemblage

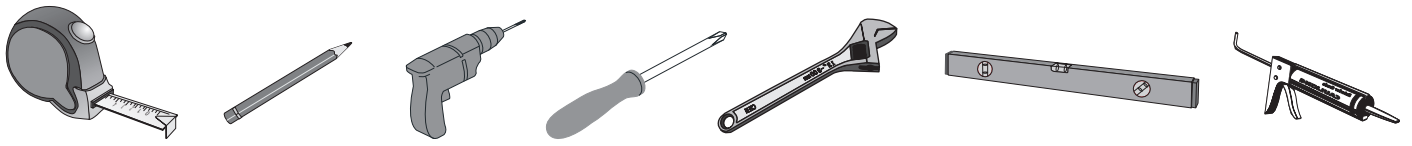

Installation Instruction/Instructions d'installation



Install/l'installation

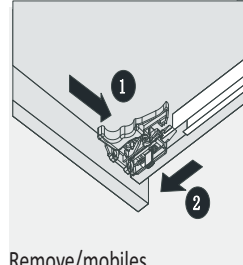
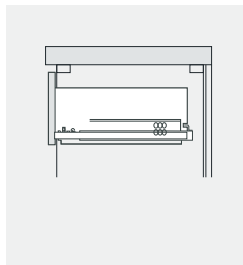
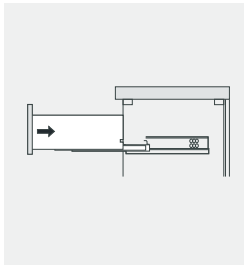

Remove/mobiles

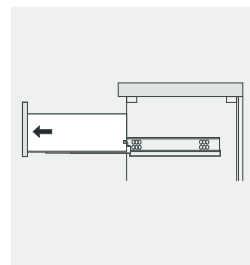

Drawer Adjust/ tiroir ajuster

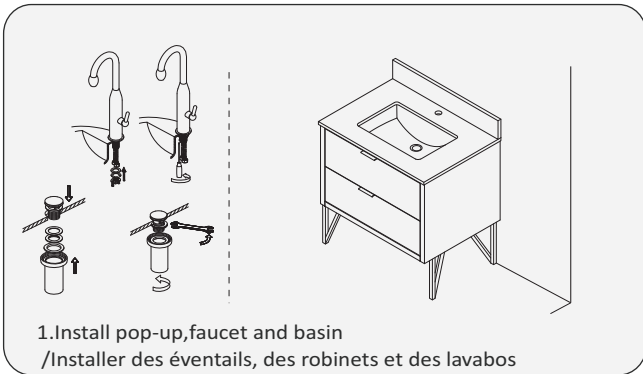

1. Install pop-up, faucet and basin
/Installer des éventails, des robinets et des lavabos

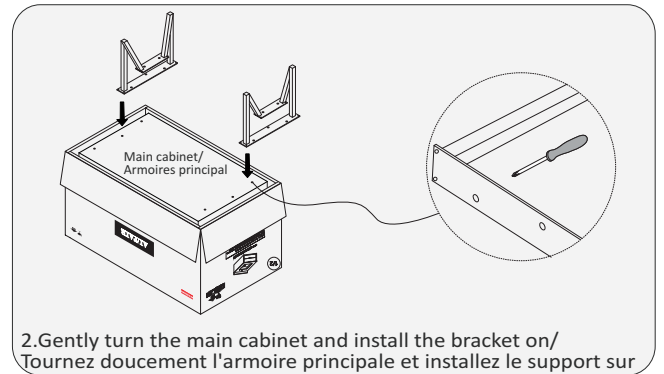

2. Gently turn the main cabinet and install the bracket on/
Tournez doucement l'armoire principale et installez le support sur

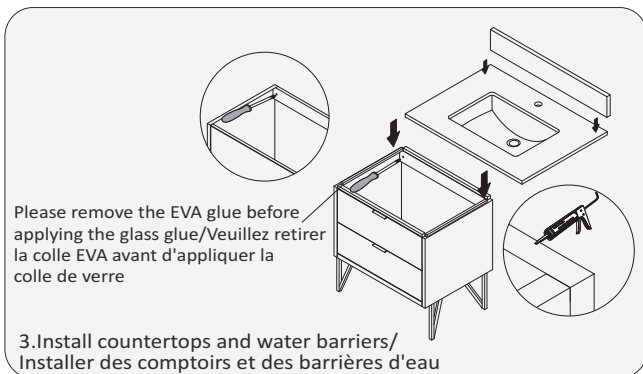

Please remove the EVA glue before applying the glass glue/Veuillez retirer la colle EVA avant d'appliquer la colle de verre

3. Install countertops and water barriers/
Installer des comptoirs et des barrières d'eau

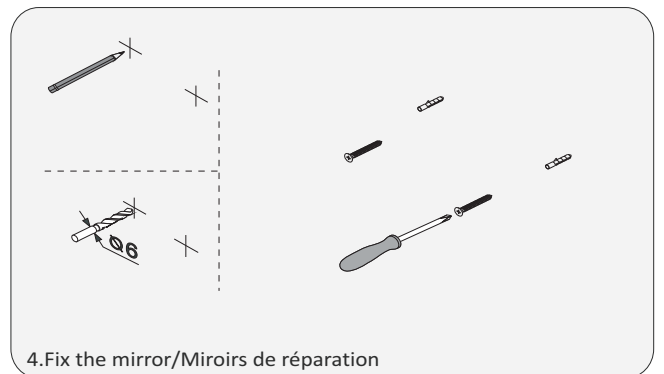

4. Fix the mirror/Miroirs de réparation

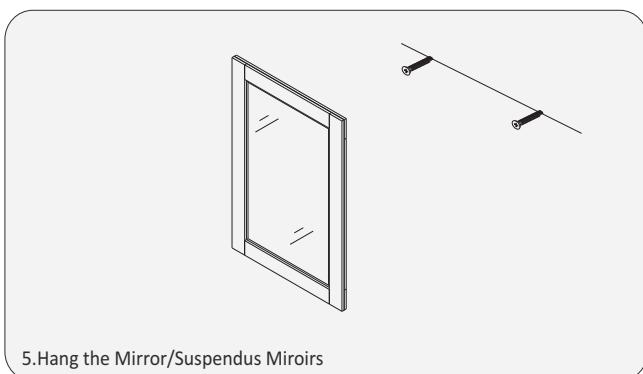

5. Hang the Mirror/Suspendus Miroirs