



**akdy**  
APPLIANCES

# Owner's Manual

## Stainless Steel Range Hood

### Island Mounts: Type A Only

Copyright akdyusa.com© 2016  
Office: +1 (626) 321-9834  
Email: support@akdyusa.com

Distributed by akdyusa.com  
Manufactured by AKDY

FOR RESIDENTIAL USE ONLY IN US & CA  
WARRANTY VOID OUTSIDE US & CA  
Revised 06/16



## IMPORTANT SAFETY INSTRUCTIONS

**WARNING:** TO REDUCE THE RISK OF FIRE, ELECTRIC SHOCK, OR INJURY TO PERSONS, READ THE FOLLOWING:

- Use this unit only in the manner intended by the manufacturer. If you have questions, please contact the manufacturer.
- Before servicing or cleaning the unit, switch the power off and lock the service panel. This will prevent the power from accidentally turning on. If the service panel does not lock, secure a warning label, such as a tag, to the service panel.
- Installation work and electrical wiring must be done by a qualified professional(s) in accordance with all applicable codes, standards, and fire-rated constructions.
- Do not operate any fans with a damaged cord or plug. Discard the fan or return to an authorized service facility for further examination and/or repair.
- To prevent back draft, sufficient air is needed for proper combustion. Gas from fuel burning equipment needs to exhaust through the flue (chimney). Follow the heating equipment manufacturer's guideline and safety standards such as those published by the National Fire Protection Association (NFPA), the American Society for Heating, Refrigeration and Air Conditioning Engineers (ASHRAE), and the local code authorities.
- When cutting or drilling into walls or ceilings; be aware of electrical wires, piping, and other utilities.
- Ducted fans must always be vented outdoors.  
**CAUTION:** For general ventilation use only. Do not use to exhaust hazardous or explosive materials and vapors.  
**CAUTION:** To reduce the risk of fire and to properly exhaust air, be sure to duct air outside - DO NOT vent exhaust air into attics, crawl spaces, garages, or within walls and ceilings.

**WARNING:** TO REDUCE THE RISK OF A RANGE TOP GREASE FIRE, READ THE FOLLOWING:

- Never leave surface units unattended at high settings. Boil-over can cause smoke and grease to spill over that may ignite. Heat oils slowly on low or medium settings.
  - Always turn the hood ON when cooking at high heat or when flambéing food (i.e. Crepes Suzette, Cherries Jubilee, Peppercorn Beef Flambé).
  - Clean ventilation fans frequently. Grease should not be allowed to accumulate on fan or filter.
  - Use proper pan size. Always use cookware appropriate for the size of the surface element.
- WARNING:** TO REDUCE THE RISK OF INJURY. IN THE EVENT OF A RANGE TOP GREASE FIRE, READ THE FOLLOWING:
- SMOTHER FLAMES with a close fitting lid, cookie sheet, or metal tray, then turn off the burner. BE CAREFUL TO PREVENT BURNS. If the flames do not go out immediately, EVACUATE AND CALL THE FIRE DEPARTMENT.
  - NEVER PICK UP A FLAMING PAN - you may be burned.
  - DO NOT USE WATER, including wet dishcloths or towels - a violent steam explosion will result.
  - Use an extinguisher ONLY if:
    - You know you have a class ABC extinguisher, and you already know how to operate it.
    - The fire is small and contained in the area where it started.
    - The fire department is being called.
    - You can fight the fire with your back to an exit.
- Based on "Kitchen Fire Safety Tips" published by NFPA.
- **WARNING:** To reduce the risk of fire or electrical shock, do not use this fan with any solid-state speed control device.

## TO REDUCE THE RISK OF FIRE, ELECTRIC SHOCK, INJURY TO PERSONS, OBSERVE THE FOLLOWING:

1. Use this unit only in the manner intended by the manufacturer. If you have questions, contact the manufacturer at the address or telephone number listed in the warranty.
2. Before servicing or cleaning unit, switch power off at service panel and lock the service disconnecting means to prevent power from being switched on accidentally. When the service disconnecting means cannot be locked, securely fasten a prominent warning device, such as a tag, to the service panel.
3. Installation work and electrical wiring must be done by a qualified person(s) in accordance with all applicable codes and standards, including fire-rated construction codes and standards.
4. Sufficient air is needed for proper combustion and exhausting of gases through the flue (chimney) of fuel burning equipment to prevent backdrafting. Follow the heating equipment manufacturer's guideline and safety standards such as those published by the National Fire Protection Association (NFPA), and the American Society for Heating, Refrigeration and Air Conditioning Engineers (ASHRAE), and the local code authorities.
5. When cutting or drilling into wall or ceiling, do not damage electrical wiring and other hidden utilities.
6. Ducted fans must always be vented to the outdoors.
7. Acceptable for use over a tub or shower when connected to a GFCI (Ground Fault Circuit Interrupter) - protected branch circuit (ceiling installation only).
8. This unit must be grounded.

## CAUTION

1. For general ventilating use only. Do not use to exhaust hazardous or explosive materials and vapors.
2. This product can be installed in a wall if mounted 8-ft. or more above the floor.
3. To avoid motor bearing damage and noisy and/or unbalanced impellers, keep drywall spray, construction dust, etc. off power unit.
4. Please read specification label on product for further information and requirements.

### Your safety and the safety of others are very important.

We have provided many important safety messages in this manual and on your appliance. Always read and obey all safety messages.



This is the safety alert symbol.

This symbol alerts you to potential hazards that can kill or hurt you and others.

All safety messages will follow the safety alert symbol and either the word "DANGER" or "WARNING."

These words mean:

**DANGER**

You can be killed or seriously injured if you don't immediately follow instructions.

**WARNING**

You can be killed or seriously injured if you don't follow instructions.

## TOOLS & PARTS REQUIREMENTS

- \* Electrical drill or ratchet driver
- \* 1/2" drill bit for drilling pilot holes
- \* 1 1/4" drill bit for drilling electrical wiring access hole
- \* Screwdrivers: Phillips & Straight blade
- \* Pliers
- \* Tape measure or ruler and pencil
- \* Electrical supplies for wiring
- \* Aluminum foil tape and/or HVAC tape
- \* Hammer
- \* Jigsaw or saber saw
- \* Stud finder

## PARTS SUPPLIED

- \* Body & Main Unit: 1 pc.
- \* Chimney Mounting Bracket: 1 pc.
- \* Installation Manual: 1 set
- \* Chimney Cover: 1 set
- \* Metal Grease Filter: 1-4 pcs.
- \* Air Outlet & Air Damper: 1 set
- \* Exhaust Pipe & Ducting: 1 pc.
- \* Hardware: 1 set



M5 X 45 Screw (2 pc.)

M5 X 18 Screw (2 pc.)

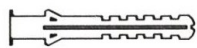

10 X 38 Wall Anchor (2 pc.)



M5 X 12 (2 pc.)



7.5 X 28 Wall Anchor (2 pc.)



M5 X 8 Screw (2 pc.)



Washer (2 pc.)



M5 X 8 (2 pc.)

## LOCATION REQUIREMENTS

Observe all governing codes and ordinances. Have a qualified technician install the range hood. It is the installer's responsibility to comply with installation clearances specified on the model serial rating plate.

Canopy hood's location should be away from strong draft areas, such as windows, doors, and strong heating vents.

Cabinet opening dimensions that are shown must be used. Given dimensions provide minimum clearance.

### A. Countertop Height

**B.** Hood height from ceiling to bottom of the range hood filter surface:  $D - A - C = B$

**C.** 29" (73.66 cm) min. from cooking surface, suggested 31" (78.74 cm) max.

### D. Ceiling Height

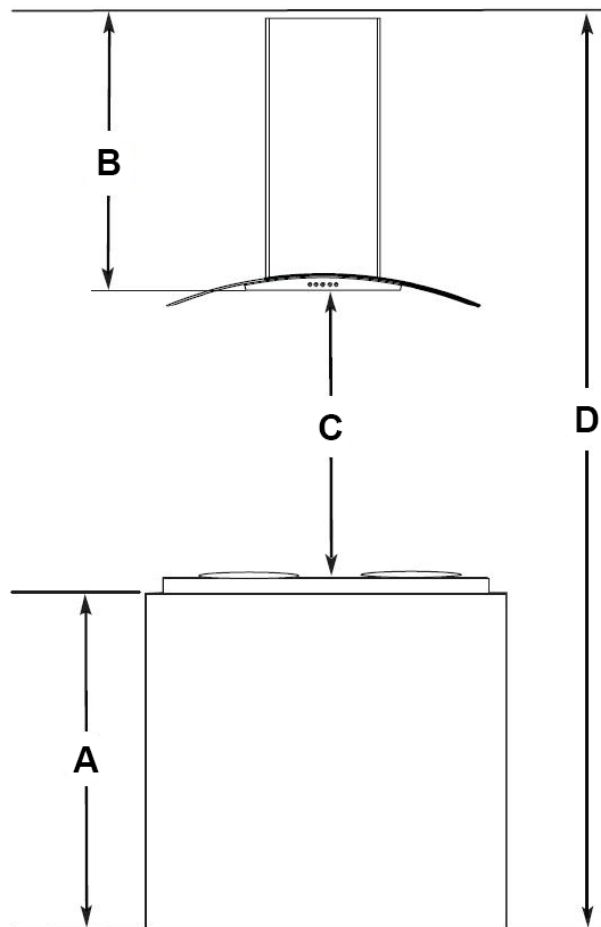

## VENTILATION REQUIREMENTS

Range hoods must be ventilated to the outdoors, except for non-vented (recirculating) installations.

- \* Do not ventilate the range hood into an attic or other enclosed areas.
- \* Do not use 4" (10.2 cm) laundry-type wall caps.
- \* The length of the range hood and the number of elbows should be kept to a minimum to provide maximum performance.

## For the Most Efficient and Quiet Operation

- \* Use no more than three 90° elbows.
- \* Make sure there is a minimum of 24" (61 cm) of straight duct between the elbows if more than one elbow is used.
- \* Do not install two elbows together.
- \* Use clamps to seal all joints in the vent system.
- \* The vent system must have a damper. If the roof or wall cap has a damper, do not use the damper supplied with the range hood.
- \* Use caulking to seal exterior walls or roof openings around the cap.
- \* The size of the vents should be uniform.

## Makeup Air

Local building codes may require the use of makeup air systems, when using ventilation systems greater than specified CFM of air movement. The specified CFM varies from state to state. Consult your HVAC professional for specific requirements in your area.

## Cold Weather Installations

An additional back draft damper should be installed to minimize backward cold air flow. A thermal break should be installed to minimize conduction of outside temperatures as part of the vent system. The damper should be on the cold air side of the thermal break. The break should be as close as possible to where the vent system enters the heated portion of the house.

## Venting Method

This canopy hood is factory set for through the roof or wall. A 6" (15.2 cm) round vent system is needed for installation. The hood exhaust opening is 6" (15.2 cm) round. To vent through a wall, a 90° elbow is needed. If exhaust ducting with a diameter of less than 5.91" (150 mm) or if flat ducting is used, the noise level of the range hood will increase and extraction will be less efficient.

## Rear Discharge

A 90° elbow may be installed immediately above the hood.

# Recirculating Installations & Carbon Filters

## Non-Vented (Recirculating) Installations

If it is not possible to vent cooking fumes and vapors to the outside, the hood can be used in the non-vented (recirculating) version, fitting a carbon filter at the motor. Fumes and vapors are then recycled through the top grille. Do not block the chimney holes and vents on either side.

Non-vented (recirculating)

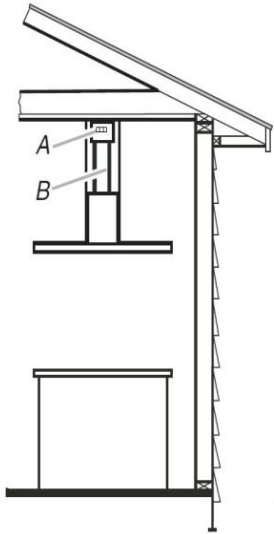

A. Chimney hole  
B. 6" (15.2 cm) round vent

Roof Venting

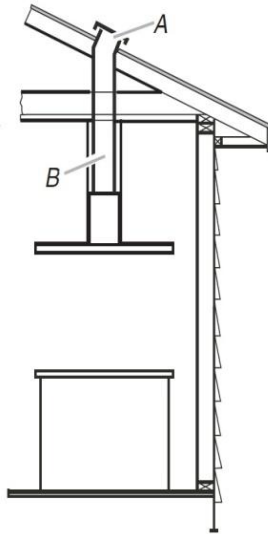

A. Roof cap  
B. 6" (15.2 cm) round vent

## Carbon Filter Care Guide

Carbon filters have to be replaced approximately every 6 months depending on the frequency of use. They cannot be washed and reused. Please replace carbon filters when your kitchen air is no longer smelling fresh and dispose of the used ones.

**DO NOT WASH**

**DO NOT REUSE**

**DO NOT OPEN**

## Ordering Carbon Filters

Carbon filters can be ordered on: ShopRangeHoods.com or by phone at: +1 (626) 321-9834. Please ask for Sales.

- \* Navigate to *Replacement Parts* in the navigation bar
- \* Click *Recirculating Kit*
- \* Under *Options*, click and choose your model number/PID
- \* Checkout to complete the ordering process

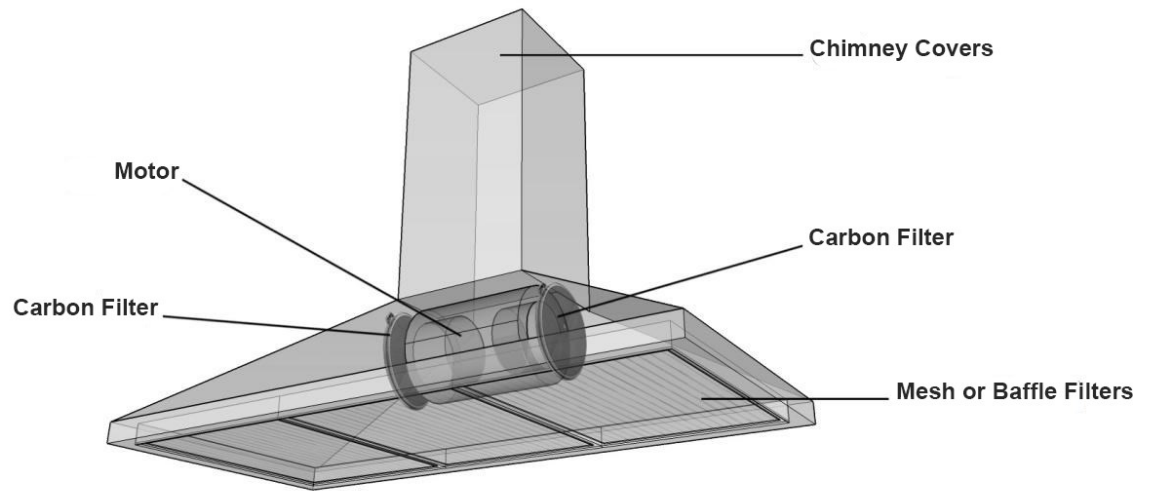

\*Range Hood Pictured Will Vary

## Installation Steps for Recirculating

Prerequisites:

- \* 1 set of carbon filters (2 pcs.) [Recirculating Kit]

Step 1: Remove the mesh or baffle filters

Step 2: Locate the motor and the carbon filter clips on each side

Step 3: Place the carbon filters into the corresponding ends of the motor

Step 4: Twist each carbon filter until it clips into place

# Cleaning & Maintenance

## Cleaning Mesh or Baffle Filters

Mesh and baffle filters can be cleaned with regular household dish washing soap and hot water. Please wear gloves while cleaning filters to protect against scrapes or cuts. Exercise caution around sharp metal edges and corners.

### Ingredients

- \* Very hot or boiling water
- \* Dishwashing soap or degreaser
- \* Baking soda
- \* Non-abrasive scrubbing brush or pad
- \* Dish cloth or paper towels

### Instructions

1. **Remove the Filters from the Hood:** Using the included latch (on mesh filters only), remove them from underneath the range hood.
2. **Fill Your Sink Hot or Boiling Water:** Hot water will help dissolve hard grease and oil built up on the filters.
3. **Add Dishwashing Soap or Degreaser:** Pour in a generous amount of cleaning solution and make sure it is completely dissolved in the water.
4. **Add Baking Soda:** Pour in baking soda to the solution,
5. **Soak Mesh Filters:** Place your filters into the solution and let it soak for up to 30 minutes.
6. **Scrub the Filters:** After soaking, take a scrubbing brush or pad to further remove grease and oil.
7. **Rinse and Let Dry:** Thoroughly rinse with clean water and let dry them with a cloth or paper towels.
8. **Reinstall the Filters:** Carefully reinstall the metal filters once fully dry.

## Types of Metal Filters

### Mesh

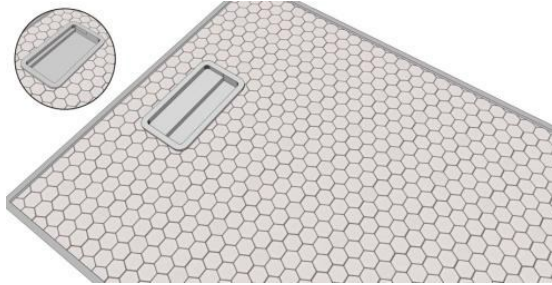

### Baffle: Type A

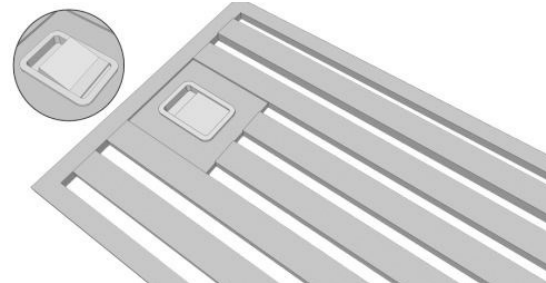

### Baffle: Type B

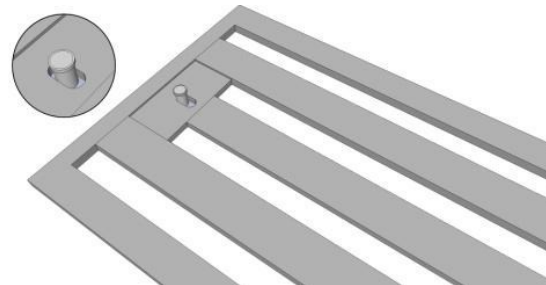

## Interior Range Hood Cleaning

The unit must be turned off before being cleaned. Also avoid spraying cleaner directly onto the light bulb or light bulb socket. You can clean the interior of the vent hood with a standard household degreaser/cleaner and a sponge or rag; it will probably get quite dirty, so make sure to use something that you don't mind throwing away afterward.

## Exterior Oven Vent Cleaning

The exterior of a vent hood may also be cleaned with a standard household degreaser/cleaner or a non-abrasive cleanser. Since exterior range hood cleaning is a lot easier to do, you may want to incorporate it into your daily or weekly cleaning routine. If your vent hoods have never been cleaned, you may want to call in a professional to do the job the first time, as it is very likely that it will be pretty messy.



# AKDY Island Mount Range Hood: Type A (L-Brackets)

## Installation Steps: 1-8

For best results, please watch our accompanying installation video on YouTube: <https://www.youtube.com/watch?v=0rD9pmHi7Rg>



1. Begin by locating the area of the ceiling where the island mount range hood will be installed at.



2. Take the included ceiling plate and mark the location by tracing along the inside.

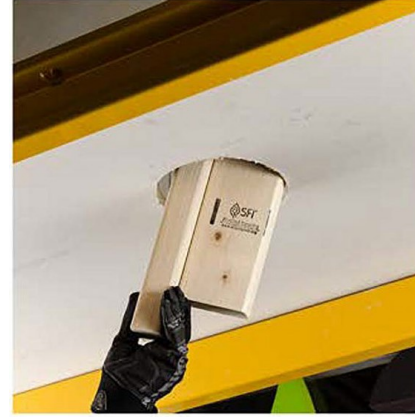

3. Using a rotary tool, cut a six inch round hole through the ceiling (only if required). Insert 2x4 wood supports into the ceiling. 2x4s will be used to create a ceiling support system to secure the island hood where studs are not available.



4. Arrange the 2x4s as shown. Two L-shaped pieces should be placed across from each other. T-shaped pieces are added next to form a square base around the perimeter of the exhaust hole. You may need roof access.



5. The T-shaped 2x4s should align and meet above the holes for the ceiling plate.



6. Using the included hardware, secure the ceiling plate into the wooden support created earlier. Ensure the screws are fastened into the 2x4s.

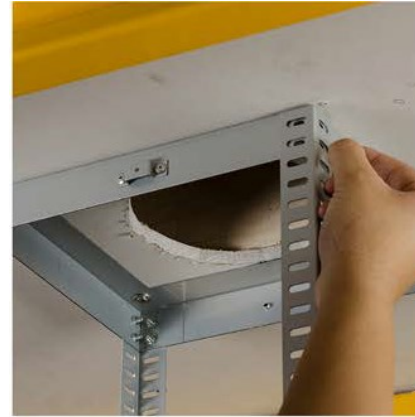

7. Take the included L-brackets and position them into place.



8. As needed, use an additional screwdriver to fasten the L-bracket.

# AKDY Island Mount Range Hood: Type A (L-Brackets)

## Installation Steps: 9-16

For best results, please watch our accompanying installation video on YouTube: <https://www.youtube.com/watch?v=0rD9pmHi7Rg>



9. Each L-bracket requires 4 screws and nuts for every corner.



10. Once the initial 4 L-brackets are installed, proceed with the remaining L-brackets. You may need to measure and adjust the dropdown length depending on your kitchen.



11. As needed, use an additional screwdriver to fasten the L-bracket.



12. The completed support frame will look as pictured.



13. Using the included duct pipe, insert it through the hole in the ceiling and connect it to your existing duct work (if applicable). You may need roof access.

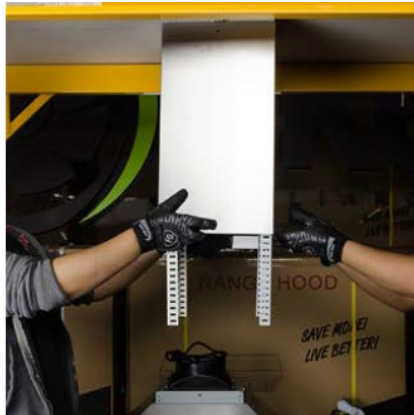

14. Insert the inner chimney cover over the support system followed by the outer chimney. You may require an extra set of hands for this step. Note the location of the screw hole on the ceiling plate and the corresponding hole in the inner chimney cover.

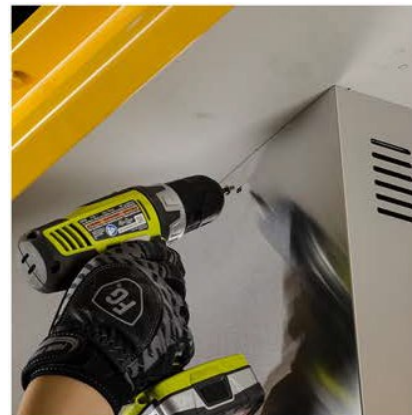

15. Position the range hood onto the support frame.

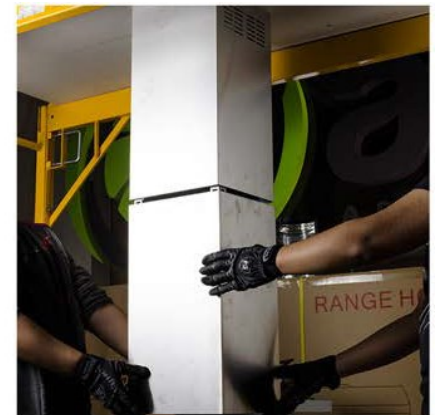

16. Use the included screws to secure the main unit to the support frame. You may require an extra set of hands for this step.



# AKDY Island Mount Range Hood: Type A (L-Brackets)

## Installation Steps: 17-24

For best results, please watch our accompanying installation video on YouTube: <https://www.youtube.com/watch?v=0rD9pmHi7Rg>



17. As pictured, each corner uses 4 screws to secure the main unit to the support frame.



18. Connect the duct to the damper/air flapper onto the main unit.



19. Secure the duct to the damper/air flapper with HVAC foil tape (as pictured) or duct tape.

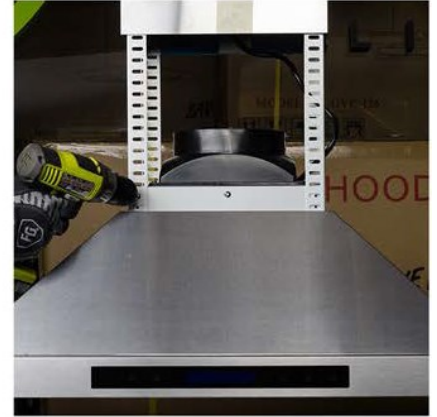

20. Feed the power cord through the ceiling hole.



21. Take the inner chimney cover and slide it up flush with the ceiling plate.



22. Secure the inner chimney cover to the ceiling plate with the included screws.



23. Plug in the power cord to the outlet in the ceiling. If no outlet is available, one will need to be installed. The outlet can also be installed outside of the ceiling, but modification to the inner chimney will be required to accommodate the power cord.



24. Make any necessary adjustments to the wooden supports and studs to ensure it is rigid and strong.



# Adjusting the Clock

## Control Panel: Type A

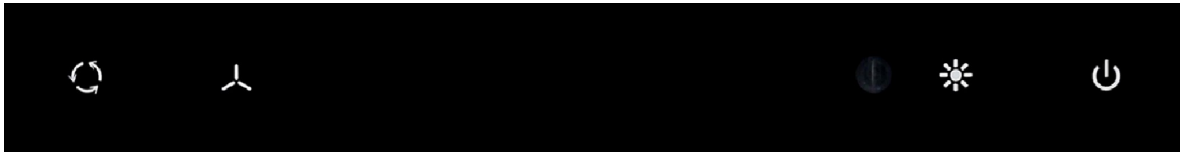

## Control Panel: Type B1



## Control Panel: Type B2



## Control Panel: Type C



## Clock Setting: Type A

Step 1: Tap  and hold for 3 secs.

Step 2: Tap  repeated to set the hour.

Step 3: Tap  to switch to mins.

Step 4: Tap  again repeatedly to set the mins.

Step 5: Tap  again to finish.

## Clock Setting: Type B

Step 1: Tap  and hold for 3 secs.

Step 2: Tap  OR  repeatedly to set the hour.

Step 3: Tap  OR  to switch to mins.

Step 4: Tap  OR  again repeatedly to set the mins.

Step 5: Tap  again to finish.

## Clock Setting: Type C

Step 1: Tap  and hold for 3 secs.

Step 2: Tap  repeatedly to set the hour.

Step 3: Tap  repeatedly to set the mins.

Step 4: Tap  again to finish.

# Adjusting the Clock

## Control Panel: Type D



## Control Panel: Type E



## Clock Setting: Type D

Step 1: Tap and hold  for 3 secs.

Step 2: Tap  OR  repeated to set the hour.

Step 3: Tap  to switch to mins.

Step 4: Tap  OR  repeatedly to set the mins.

Step 5: Tap  again to finish.

## Clock Setting: Type E

Step 1: Tap and hold  for 5 secs.

Step 2: Tap 

Step 3: Tap  repeated to set the hour.

Step 4: Tap  repeatedly to set the mins.

Step 5: Tap  again to finish.

\*If your control panel is not listed, please contact us:

support@akdyusa.com | +1-626-321-9834

## **RETURNS & WARRANTY**

We thank you for your purchase. If you are not satisfied with your purchase or have an issue with our product, please kindly let us know. Our full returns policy is outlined below. Carefully read over our terms before contacting us. If you have questions, our customer service team can be reached at: +1 (626) 321-9834 or support@akdyusa.com.

For 1-3 years from the date of purchase, when this major appliance is operated and maintained according to instructions attached to or furnished with the product, akdyusa.com will pay for Factory Specified Parts. This limited warranty is valid only in the United States or Canada and applies only when the major appliance is used in the country in which it was purchased. Outside the United States and Canada, this limited warranty is null and void. Proof of original purchase date is required to obtain service under this limited warranty.

## **DISCLAIMER OF IMPLIED WARRANTIES: LIMITATION OF REMEDIES**

CUSTOMER'S SOLE AND EXCLUSIVE REMEDY UNDER THIS LIMITED WARRANTY SHALL BE PRODUCT REPAIR AS PROVIDED HEREIN. IMPLIED WARRANTIES, INCLUDING WARRANTIES OF MERCHANTABILITY OR FITNESS FOR A PARTICULAR PURPOSE, ARE LIMITED TO ONE YEAR OR THE SHORTEST PERIOD ALLOWED BY LAW. AKDYUSA.COM SHALL NOT BE LIABLE FOR INCIDENTAL OR CONSEQUENTIAL DAMAGES. SOME STATES AND PROVINCES DO NOT ALLOW THE EXCLUSION OR LIMITATION OF INCIDENTAL OR CONSEQUENTIAL DAMAGES, OR LIMITATIONS ON THE DURATION OF IMPLIED WARRANTIES OF MERCHANTABILITY OR FITNESS, SO THESE EXCLUSIONS OR LIMITATIONS MAY NOT APPLY TO YOU. THIS WARRANTY GIVES YOU SPECIFIC LEGAL RIGHTS, AND YOU MAY ALSO HAVE OTHER RIGHTS WHICH VARY FROM STATE TO STATE OR PROVINCE TO PROVINCE.

## **MANUFACTURER'S WARRANTY**

akdyusa.com provides a 3-year limited parts warranty for all range hoods, and a 1-year limited parts warranty for all bathtubs, tub fillers, kitchen sinks, kitchen sinks, shower heads, shower wands, and shower panels. Under this warranty, you (the customer), is entitled to replacement parts at no cost to repair and restore functionality if any part of the product were to fail. No labor is provided. Certain consumables that are not covered under this warranty include:

- \* Lights (halogen and LEDs)
- \* Carbon Filters
- \* Mesh or Baffle Filters
- \* Ducting

The above parts are guaranteed to last one year beginning from the date of purchase. If they fail prematurely or are defective within 1 year of purchase, akdyusa.com will replace them at no charge.

If a main unit or complete replacement has to be sent, akdyusa.com will require that the customer pay for shipping. Shipping for parts are free under the warranty period.

## **RETURNS, DAMAGES, MISSING PARTS**

### **Ground Shipments – Range Hoods, Shower Heads/Wands, Sinks, Tub Fillers**

We accept all returns within 30 days with return shipping to be paid by the customer if the item was:

- \* deemed unsuitable
- \* the wrong size
- \* purchased but not used
- \* an accidental purchase
- \* buyer's remorse

### **Resolution Process for Damages or Missing Items (Ground Shipments)**

- 1a. Customer provides images of damage (mandatory)
- 1b. Customer notifies us (akdyusa.com) for missing parts or items
- 2a. We send a replacement unit (discretionary)
- 2b. We send replacement parts
3. Customer is provided a new tracking number for the replacement or parts shipped via Ground shipping or Parcel

### **Freight Shipments – Bathtubs, Oversized Range Hoods**

All bathtubs will ship via freight. Due to the large size and weight, please allow approximately 2 weeks for the item to arrive. If you have received a freight shipment, please kindly:

- \* inspect for damages (ex: cracks, chips, etc.)
- \* inspect for missing parts or items part of a bundle

### **Resolution Process for Damages or Missing Items (Freight Shipments)**

- 1a. Customer provides images of damage (mandatory)
- 1b. Customer notifies us (akdyusa.com) for missing parts or items
- 2a. We send a replacement unit (discretionary)
- 2b. We send replacement parts
3. Customer is provided a new tracking number via our 3<sup>rd</sup> party LTL carrier for the replacement or parts

If the customer contacts us after the 30-day window for a return, akdyusa.com will require a 15-40% restocking fee to be applied to the return depending on the condition of the item and the number of days passed the standard 30-day window.

If shipping damage is noticeable upon arrival, please immediately reject the package, take pictures of the damages, and contact customer support for assistance.

If the item is delivered and arrived damaged, we will either send a

replacement and take back the damaged item, or send parts to repair the item depending on the severity of the damage. A full replacement will be issued only under our discretion. Under certain authorized vendors who carry our products, shipping damages that require a full replacement will require contacting the seller and not akdyusa.com.

All shipping damages must be reported within 30 days of delivery. Missing or lost items must be reported within 7 days of delivery. The customer must also notify the local authorities to obtain a police report if the tracking information shows the item as being delivered, but not received. A replacement part or unit will be shipped out only if these rules are met. After the 30-day window for damaged items or 7 days for lost and missing packages, akdyusa.com reserves the right to not ship replacement parts or complete units. No exceptions will be made and we will not be held responsible.

## **WARRANTY EXCLUSIONS**

The included warranty is null/void and does not cover the following conditions:

1. Service calls to correct the installation of your major appliance, to instruct you on how to use your major appliance, to replace or repair house fuses, or to correct house wiring or plumbing.
2. Service calls to repair or replace appliance light bulbs, air filters or water filters. Consumable parts are excluded from warranty coverage.
3. Repairs when your major appliance is used for other than normal, single-family household use or when it is used in a manner that is contrary to published user or operator instructions and/or installation instructions.
4. Damage resulting from accident, alteration, misuse, abuse, fire, flood, acts of God, improper installation, installation not in accordance with electrical or plumbing codes, or use of consumables or cleaning products not approved by us.
5. Cosmetic damage, including scratches, dents, chips or other damage to the finish of your major appliance, unless such damage results from defects in materials or workmanship and is reported to us within 30 days from the date of purchase.
6. Any food loss due to refrigerator or freezer product failures.
7. Costs associated with the removal from your home of your major appliance for repairs. This major appliance is designed to be repaired in the home and only in-home service is covered by this warranty.
8. Repairs to parts or systems resulting from unauthorized modifications made to the appliance.
9. The removal and reinstallation of your major appliance if it is installed in an inaccessible location or is not installed in accordance with published installation instructions.
10. Major appliances with original model/serial numbers that have been removed, altered or cannot be easily determined. This warranty is void if the factory applied serial number has been altered or removed from your major appliance. The cost of repair or replacement under these excluded circumstances shall be borne by the customer.