

access

L I G H T I N G

INSTALLATION INSTRUCTIONS

IMPORTANT SAFETY INSTRUCTIONS

MESURES DE SECURITE A RESPECTER

Before assembling your ACCESS LIGHTING fixture, please make sure that you carefully read through this instruction sheet. Save this instruction sheet and refer to it when additions to or changes in the fixture configuration are made.

Lisez attentivement ce manuel d'instructions. Enregistrer cette feuille d'instructions et de s'y référer lorsque les ajouts ou changements dans la configuration de montage sont faites.

CONSULT A QUALIFIED ELECTRICIAN TO ENSURE CORRECT BRANCH CIRCUIT CONDUCTOR.

CONSULTER UN ELECTRICIEN QUALIFIE POUR VOUS ASSURER QUE LES CONDUCTEURS DE LA DERIVATION SONT ADEQUATS

THIS PRODUCT MUST BE INSTALLED IN ACCORDANCE WITH THE APPLICABLE INSTALLATION CODE BY A PERSON FAMILIAR WITH THE CONSTRUCTION AND OPERATION OF THE PRODUCT AND THE HAZARDS INVOLVED.

CE PRODUIT DOIT ETRE INSTALLE SELON LE CODE D'INSTALLATION PERTINENT, PAR UNE PERSONNE QUI CONNAIT BIEN LE PRODUIT ET SON FONCTIONNEMENT AINSI QUE LES RISQUES INHERENTS

NOTE: The important safeguards and instructions that appear in this manual are not meant to cover all possible conditions and situations that may occur. It must be understood that common sense, caution and care, are factors that can't be built into any product. These factors must be supplied by the person(s) caring for and operating the fixture.

Read all instructions

Do not install this fixture in hazardous locations.

N'installez pas cet appareil dans des emplacements dangereux.

Do not install any fixture assembly closer than 6 inches from any curtain or similar combustible material.

Laissez une distance d'au moins 6 pouces entre ce luminaire et la toute surface combustible.

"WARNING Risk of Fire and Electric Shock."

"CAUTION: Risque d' Incendie et de Choc Electriques."

GENERAL INFORMATION

All electrical connections must be in accordance with all ordinances, Local and the U.S. National Electrical Codes (NEC). These fixtures are intended for mounting to a standard 4" metal octagon outlet box. The box must be directly supported by the building structure and U.L. Recognized.

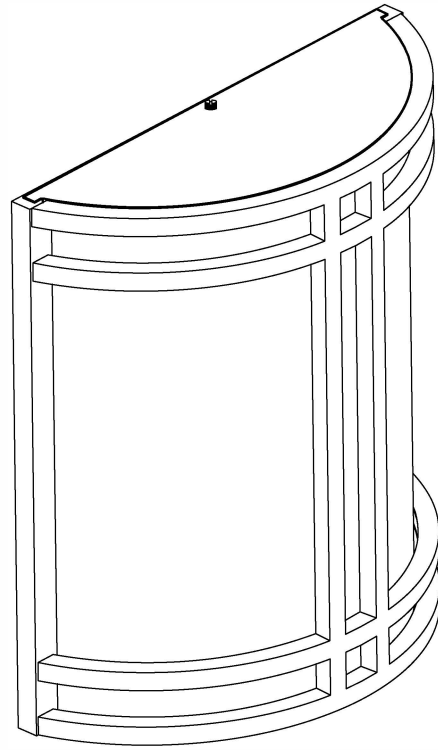

COLLECTION

Artemis

APPLICATION

Wall Fixture

MODEL NO.

20362LEDDL

WHAT WE PROVIDE

- Fixture
- Crossbar
- Mounting Hardware
- 1 x Glass Shade
- 2 X A19 E-26 LED Bulbs

WHAT YOU NEED

- Screwdriver
- Wire Cutters
- Wiring Supplies as Specified by Electrical Code

Recommended Dimmers for Supplied Bulb

(ELV) LUTRON Skylark SELV-300P

(MLV) COOPER Aspire 9530SW

(TRIAC) LEGRAND Titan CD703-PW

STEP BY STEP INSTRUCTIONS

Before starting your installation disconnect the Power by turning off the Circuit Breaker or by removing the fuse at the fuse box. Just turning the light off at the light switch is not sufficient to prevent electrical shock.

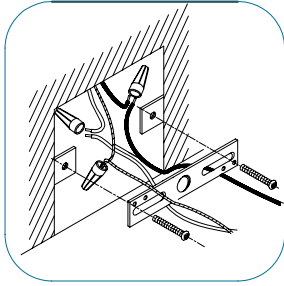

1

MOUNT CROSSBAR

If there is an existing fixture remove it. Expose the supply wires from the j-box. Mount the supplied crossbar to the J-Box.

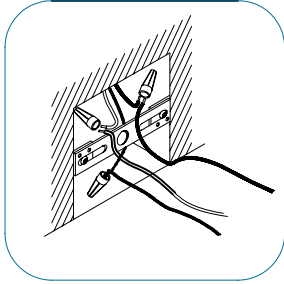

2

CONNECT THE WIRES

Gently pull the supply wires. Connect the black fixture wire to the black supply wire and the white fixture wire to the white supply wire. Connect the fixture ground wire to the ground wire from the J-Box. Secure all connections with the supplied wire connectors and U.L listed electrical tape (not supplied). Tuck all wires carefully into the J-Box.

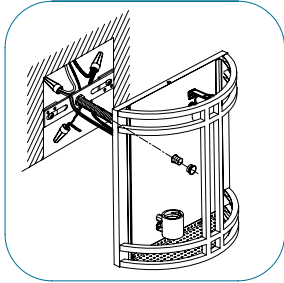

3

MOUNTING THE FIXTURE

Insert the nipple into the central hole of the crossbar, adjust length as needed and secure with the provided hex nut. Align the fixture body to the nipple and secure with provided cap nut.

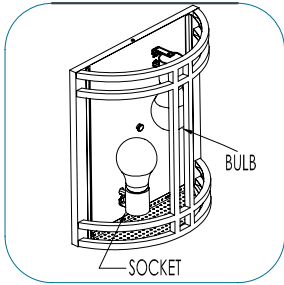

4

INSERT THE BULB

Insert the bulb.
DO NOT EXCEED THE MAXIMUM WATTAGE AS STATED ON THE WARNING LABEL

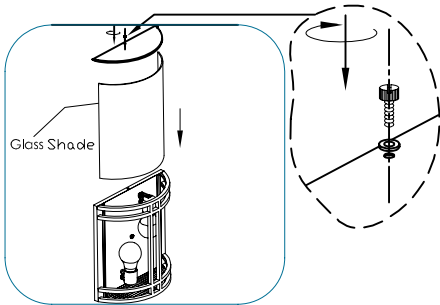

5

INSTALL THE GLASS SHADE

Slide Shade into place. Align the top cover to the fixture and secure with the decorative thumb screws.

NOTE: This fixture has been Certified, For Wet Location, and is for outside applications. Therefore to reduce the risk of electrical shock it is strongly recommended that a silicone caulking be utilized to provide a watertight seal between the fixture and its mounting surface.

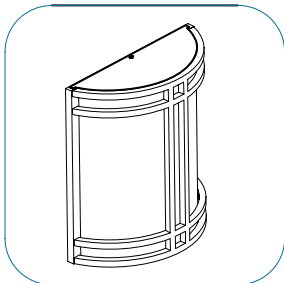

6

RESTORE THE ELECTRICITY AND CHECK THE OPERATION OF YOUR NEW ACCESS LIGHTING FIXTURE

